



4-Hole Deck Mount Hex Spout Tub Filler

ROHL Italian Country Bath Collection

A1804LH (Hex Metal Levers)

A1804LP (Porcelain Levers)

A1804XM (Cross Handles)

A1804LC (Swarovski® Crystal Levers)

A1804XC (Swarovski® Crystal Cross Handles)

FEATURES

- Art Deco design hex spout
- 1/4-turn ceramic valves
- 4 x 1 5/16" cutouts
- 8 5/32" spout reach
- 5 43/64" spout height
- Single-function brass handshower with metal insert on A1804LH/XM/LC/XC and white porcelain insert on A1804LP
- 6 1/2' hose
- 15-17 GPM at 45 PSI
- 3/4" NPT connectors
- Solid brass

COLORS/FINISHES

- Polished Chrome
- Polished Nickel
- Satin Nickel
- Tuscan Brass
- Inca Brass

WARRANTY

- Limited Lifetime*
- * No Warranty on Tuscan Brass Finish (TCB)

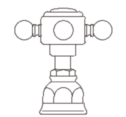
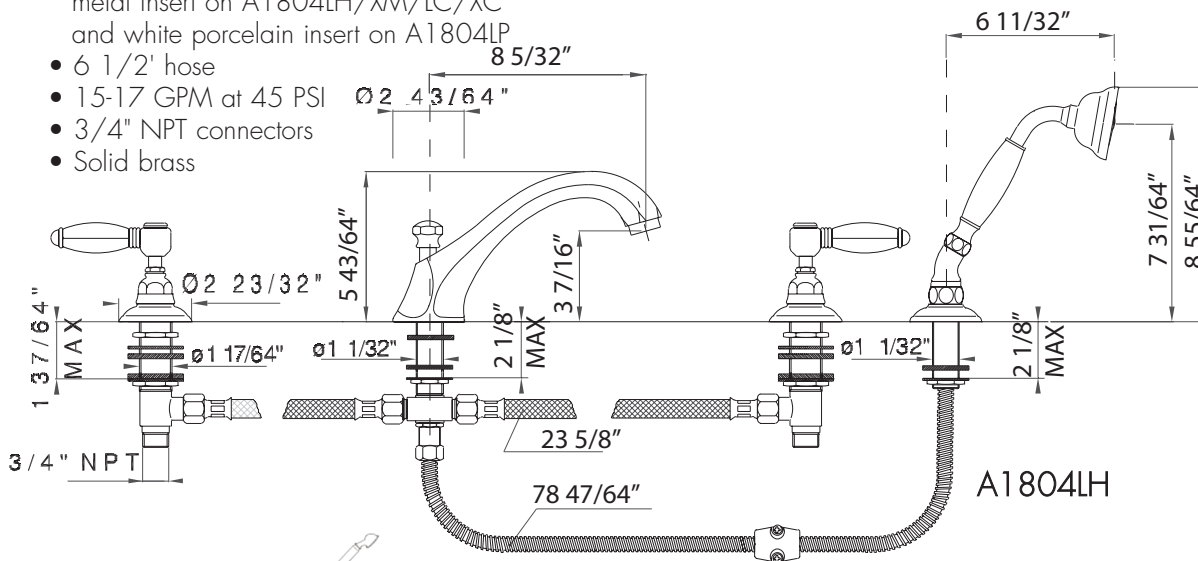

A1804XM

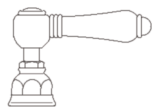

A1804LP

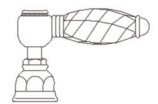

A1804LC

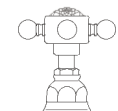

A1804XC

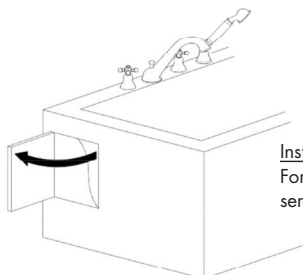

Installation note
For servicing after installation, install a service door near the valves

A1804 Spare Parts

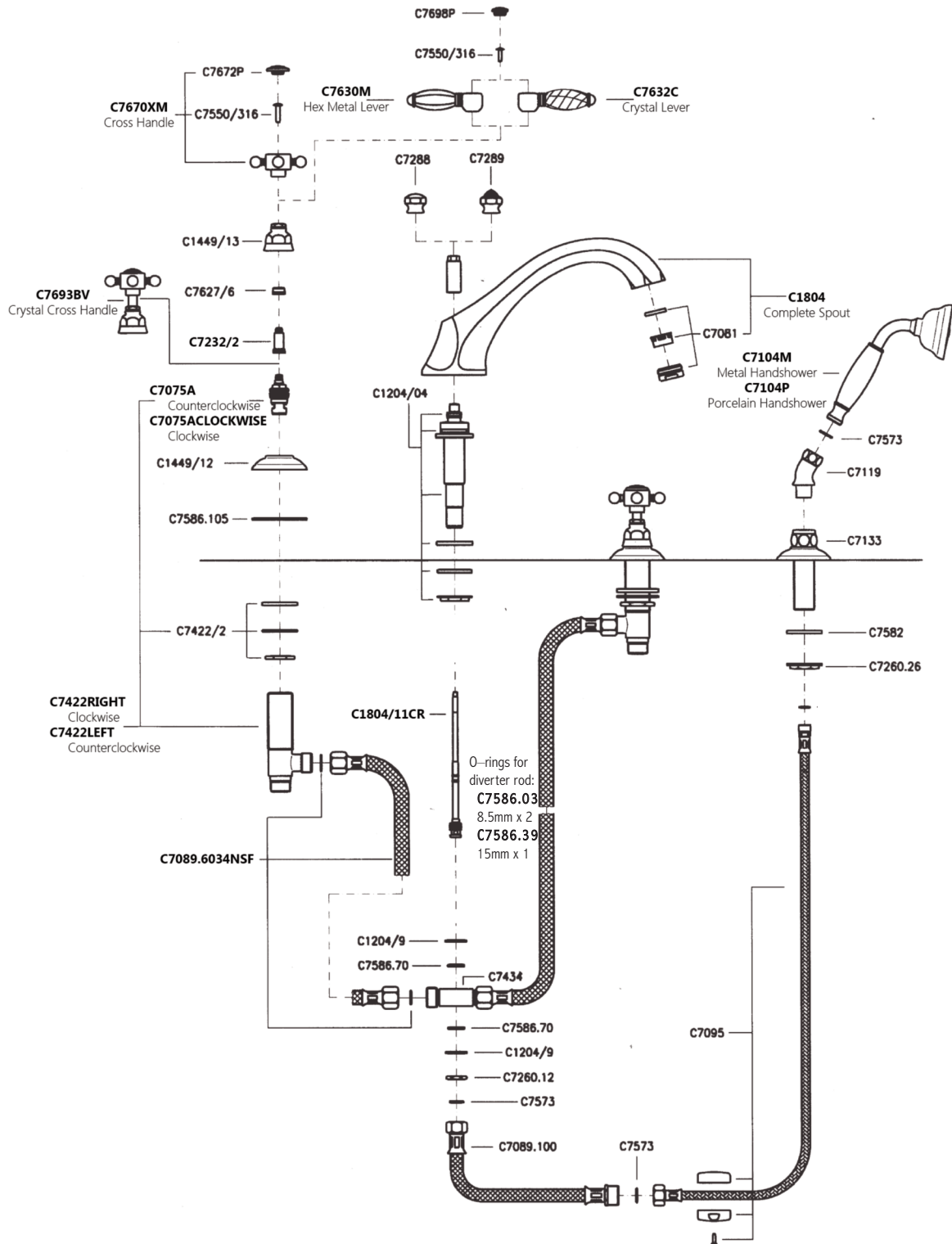

Consult your local ROHL showroom for additional information and specifications. For complete warranty details and a list of showrooms, go to www.rohlhome.com.

Installation Instructions

INSTALLATION AND CARE & MAINTENANCE GUIDE

Installation guide

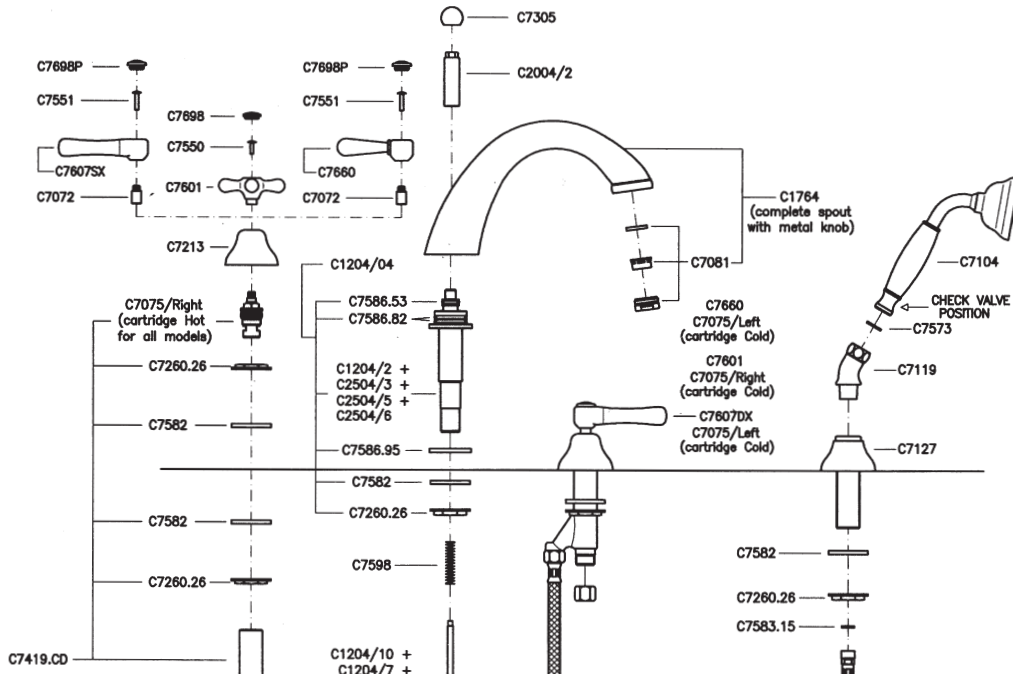

Installation must comply with local plumbing codes

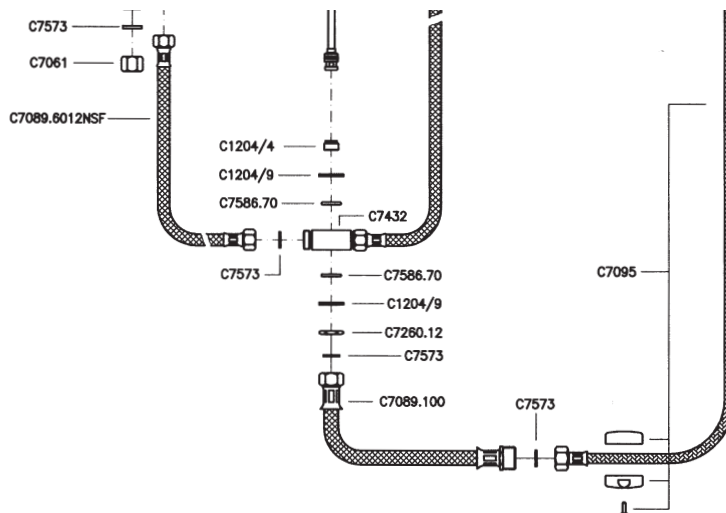

Consult your local ROHL showroom for additional information and specifications. For complete warranty details and a list of showrooms, go to www.rohlhome.com.

Installation Instructions

A T T E N T I O N

Maximum fixing nut torque value = 10 lbf.ft.

- Repeat this procedure for the cold valve.
- Connect the hot and cold valve body (I) to the two holes cross (B) using the flexible hoses (L) and placing the washer between the two parts.
- Unscrew the fixing kit of the shower holder on bath edge (M).
- Introduce the shower holder in the hole of the deck and fix it, placing before the rubber washer and then the metal disk and the nut.
- Connect the nylon flex hose (N) to the stainless steel hose (U), placing the washer between the two parts.
- Connect the stainless steel hose (U) to the spout (D) with the hexagonal nut, placing the washer between the two parts.
- Introduce the other end of hose in the shower holder (M).
- Connect the hose to the curved joint (O), placing the washer between the two parts.
- Connect the hand shower (P) to the curved joint (O), placing the washer between the two parts.
- Assemble counterweight (Q) at the nylon flex hose (N).
- Connect hot and cold water supplies to side valve inlet.
- Ensure all connections are firmly tightened.

c – Before use

Turn on the Hot and Cold supplies to the faucet.

Maximum temperature for Hot water supply to the faucet is 145° F.

Minimum recommended pressure is 15 psi – Maximum recommended pressure is 75 psi.

Check the installation carefully for leaks.

If further building work is to be carried out in the vici of the faucet, it should be covered to prevent paint, adhesive, etc. from damaging the surface.

Care and use for finishes

Country Bath Products are all authentic finishes that have not been coated with any product.

After each use, pat the fixture down to remove any excess water. This will prevent any water spotting or mineral build-up. Use only soft liquid soap and water to clean the surface. Use a soft brush to clean any gaps. Avoid any products that have ammonia or alcohol like Windex, 409 or Fantastik. These products can damage the finish leaving black or white spots. Never use an abrasive product like Softscrub, Comet, Ajax or Bon Ami.

For deep polishing we recommend Bruno's Wax for all finishings.

Tuscan Brass is a living finish and has no warranty. It will lighten with use. To extend the life of the finish, apply Bruno's Wax by patting it on, letting it dry and patting it off. Never rub or buff this finish.

WARNING: the use of cleaning products not recommended might irreparably harm the surfaces of the faucets which in such case are not covered by our warranty.

Limescale

The faucet is fitted with an aeration device in the Hot/Cold water outlet.

This may need occasional cleaning especially in hard water areas.

This is accomplished by unscrewing the outlet in a counter clockwise direction, dismantling and leaving the inner screen mesh immersed over night in vinegar or lemon juice.

Do not use chemical descaling liquids for this purpose.

ATTENTION

READ THESE INSTRUCTIONS BEFORE INSTALLATION AND USE OF ALL FAUCETS AND WALL VALVES

INSTALLATION and WARRANTY INSTRUCTIONS TECHNICAL INFORMATION

All flexible hoses are designed and manufactured for use with water in exposed locations only. **Do not expose** to household cleaners, chlorine, chloride, hydrochloric acid or other corrosive chemicals.

- All connections with threads M10x1 male must be hand tighten. **Do not over tighten. Over tightening may cause damage to the hose.**

All faucets washers and o-rings are designed and manufactured for use with water. **Do not expose** to household cleaners, chlorine, chloride, hydrochloric acid or other corrosive chemicals.

Faucets are designed for use with the temperatures and pressures listed below:

- minimum cold water supply 50 °F
- maximum hot water supply 145 °F
- minimum pressure 15 psi
- maximum pressure 75 psi
- maximum fixing torque value = 10 lbf.ft.

Please note: The recommended best pressure for best performance is between 40 psi and 60 psi. More pressure than 60 psi or less pressure than 40 psi may affect the diverting action in side spray faucets.

- Do not use any Rohl Country/ Nicolazzi faucet with sulphurous water.
- The minimum temperature for all faucets is 50 degrees F. Below 50 degrees F will void the warranty.
- When available, filter systems must be placed between hot and cold supply lines and the faucet. Improper use or non-use of filters may make diverting faucets with hand sprays perform poorly.
- Don't modify faucet and their components
- Use only original spare parts if there are replacements to be ordered.
- Installation must be made by authorized plumbers or installers. Improper installation or diagnosis of problems is not covered by the warranty.
- Yearly maintenance of cleaning and flushing is recommended.

Operation and use of any faucet or wall valve that do not conform to these technical instructions will void the warranty.