

# ROHL

Authentic Luxury for Kitchen and Bath®

[www.rohlhome.com](http://www.rohlhome.com)



## PALLADIAN PRESSURE BALANCE SHOWER PACKAGE

**AKIT94LM** (Metal Lever)

**AKIT94XM** (Cross Handle)

### FEATURES

- Shower package components:
  - A2900 : Pressure Balance trim
  - 1440/6 : Shower Arm
  - B100701 : Showerhead
  - 1330 : Handshower Set
- To complete package, rough valve must be ordered separately:
  - RMV-2 – Pressure Balance Rough

### COLORS/FINISHES

- Polished Chrome
- Polished Nickel
- Satin Nickel
- Tuscan Brass

### WARRANTY

- Limited Lifetime

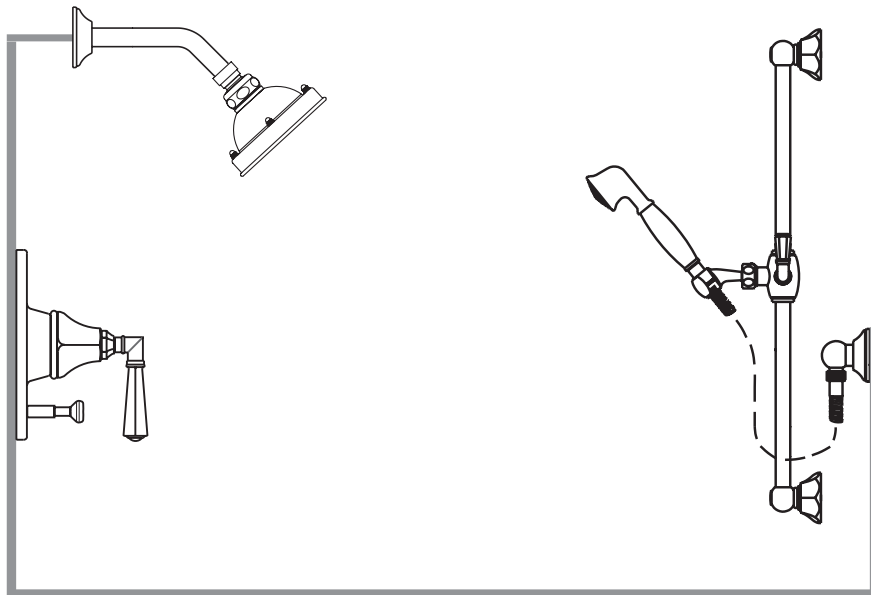



## PALLADIAN PRESSURE BALANCE TRIM WITHOUT DIVERTER

ROHL Transitional Palladian

**A1900LM** (Metal Lever)

**A1900XM** (Cross Handle)

### FEATURES

- Palladian metal lever
- Single lever control
- Coverplate, dome, and handle made from solid brass
- Trim for concealed pressure balance shower or bath valve
- **To complete package order #RMV-1 rough valve**

### COLORS/FINISHES

- Polished Chrome
- Polished Nickel
- Satin Nickel
- Tuscan Brass
- Inca Brass

### WARRANTY

- Limited Lifetime\*
- \* No Warranty on Tuscan Brass Finish

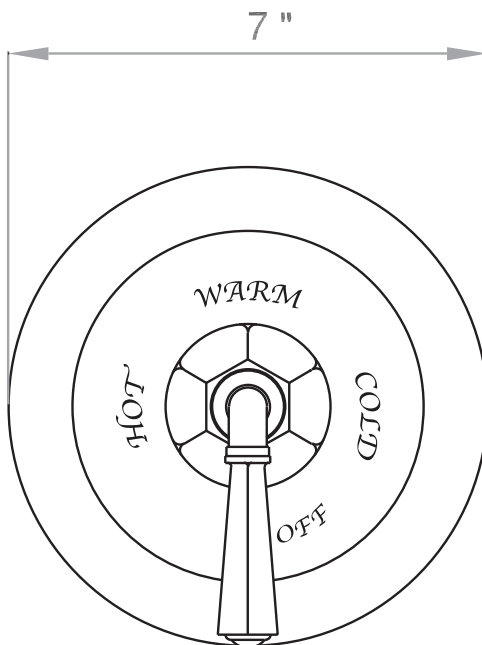

**A1900LM**

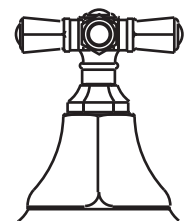
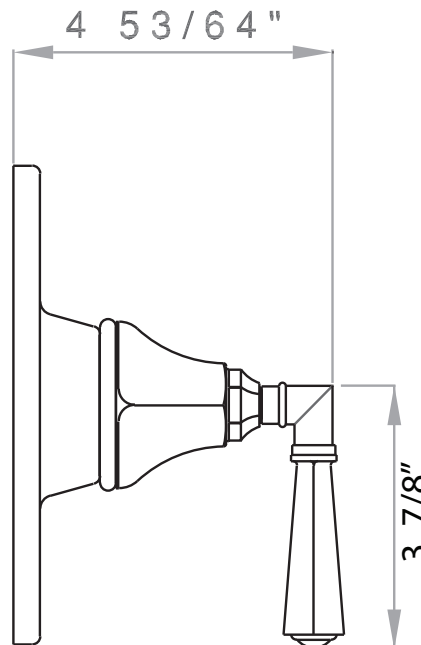

**A1900XM**

## A1900 Spare Parts and Installation Instructions

**IMPORTANT:**

THE TRIM SET A1900LM DOES NOT INCLUDE THE VALVE RMV-2. ROUGH AND TRIM MUST BE PURCHASED SEPARATELY. PLEASE NOTE THE HANDLE PIECES ARE ASSEMBLED IN THE BOX. YOU MUST DISASSEMBLE FOR INSTALLATION (SEE DRAWING).

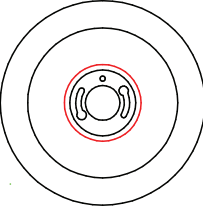

C7605/4    C7605/3    ZZ9312300    C7243/1    C7605

ALLEN KEY 3 mm.

**ASSEMBLING INSTRUCTIONS**

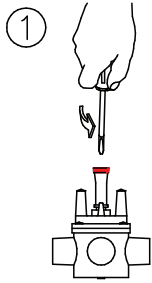
- 

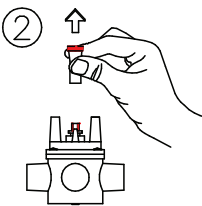
UNSCREW THE WHITE PLASTIC DRIVER ASSEMBLY.
- 

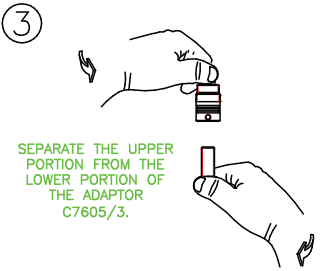
REMOVE THE WHITE PLASTIC DRIVER AND DISCARD, BUT LEAVE THE CAM STOP 1403-0696 IN PLACE (NOT PICTURED, CAM STOP IS THE STOP FOR THE PRESSURE BALANCE VALVE.)
- 

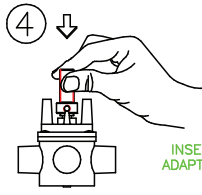
SEPARATE THE UPPER PORTION FROM THE LOWER PORTION OF THE ADAPTOR C7605/3.
- 

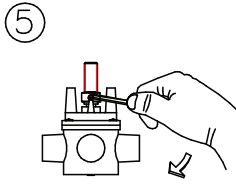
INSERT THE LOWER ADAPTOR INTO PLACE.
- 

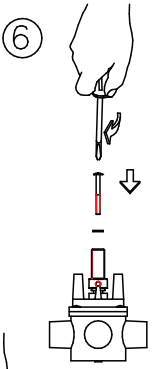
TIGHTEN THE SCREW WITH 3mm ALLEN KEY (INCLUDED)
- 

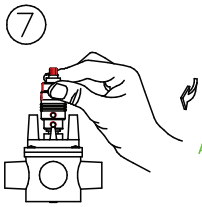
TIGHTEN THE SCREW WITH 3mm ALLEN KEY (INCLUDED)
- 

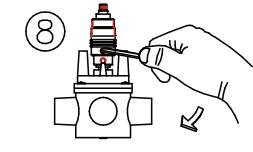
INSTALL UPPER ADAPTOR C7605/3. REFER TO INSTRUCTIONS "ADJUSTING THE ADAPTOR LENGTH" BELOW.
- 

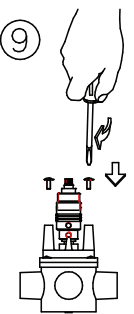
TIGHTEN THE 2 SET SCREWS WITH 3 mm ALLEN KEY (INCLUDED). LOOSELY INSTALL THE 2 FACEPLATE SCREWS.
- 

INSTALL THE 2 SCREWS. USE THE CORRECT LENGTH SCREWS.

SECURE WITH SCREW ZZ9312300.  
i. IF AN EXTENSION IS NEEDED, ORDER EXTENSION SCREW 0203-0705 WITH EXTENSION KIT 3603-1208 (NOT PICTURED).

## Installation Instructions

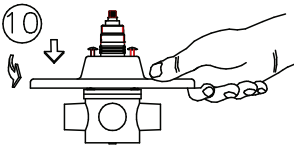

10

ROTATE THE EXTERNAL PLATE. LOOSEN THE ADAPTOR 3 mm SET SCREW AND PRE-SET THE ADAPTOR LENGTH SO THAT THE 3 O-RINGS ARE OUTSIDE THE PLATE EXTERIOR AS SHOWN. INSTRUCTIONS ARE BELOW.

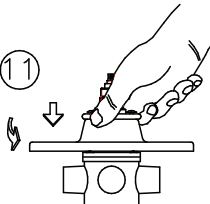

11

ROTATE THE RING C7605/4 INTO PLACE ON THE FACEPLACE SCREWS.

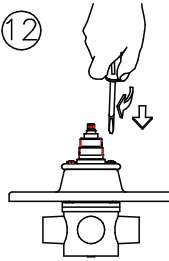

12

TIGHTEN THE 2 SCREWS.

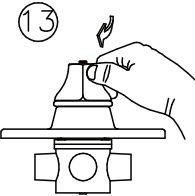

13

INSTALL THE HEX ESCUTCHEON. SCREW DOWN ALL THE WAY, THEN BACK OFF 3/4 OF A TURN. THERE SHOULD BE A GAP BETWEEN THE HEX ESCUTCHEON AND THE ADAPTOR RING TO PREVENT BINDING. FAILURE TO DO THIS MIGHT CAUSE BINDING OF THE ASSEMBLY.

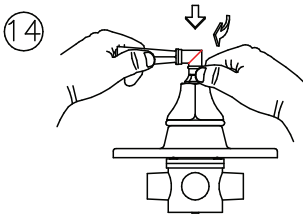

14

INSTALL THE HANDLE ASSEMBLY. HOLD THE LEVER IN THE 6 O'CLOCK POSITION AND ROTATE THE SMALL HEX DOWN ON THE ADAPTOR. THE LEVER ASSEMBLY AND THE HEX DOME WILL ROTATE TOGETHER. TEST THE ASSEMBLY FOR FREE ROTATION. SOME ADJUSTMENT MAY BE NECESSARY. A SMALL GAP BETWEEN THE HEX ESCUTCHEON AND THE ADAPTOR RING IS NECESSARY FOR FREE ROTATION.

---

ADJUSTING THE ADAPTOR LENGTH

ADJUST THE ADAPTOR TO THE CORRECT LENGTH FOR THE DEPTH OF THE VALVE

MINIMUM



MAXIMUM

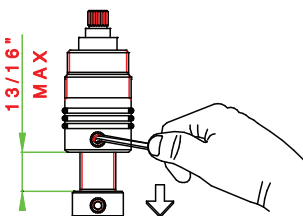

13/16" MAX

ADJUSTING THE ADAPTER LENGTH

LOOSEN THE TWO UPPER SET SCREWS. SCREW THE UPPER PIECE FROM THE LOWER PIECE TO THE CORRECT LENGTH BUT NO MORE THAN 13/16" MAXIMUM. ONCE THE DEPTH IS CORRECT, TIGHTEN THE TWO UPPER SET SCREWS.

---

ATTENTION: ENSURE ALL PARTS ARE FIRMLY TIGHTENED