

Craft Series Vanity Top
TA30MCOXXX-8CS8 Integrated Basin Vanity Top Specification Sheet

FEATURES

- Mineral cast integrated sink and top
- 8" (203 mm) widespread faucet holes
- Rectangular basin
- Overflow drain
- Removable drain cover

CODES & STANDARDS

- UPC/cUPC certified to IAPMO requirements

OPTIONS

Finish colors available:

- TA30MCO102-8CS8 - Matte White

Compatible Craft Series Vanities:

- CVSK3020469 - Skaarsgard, Rustic Oak with Brushed Pewter

DIMENSIONS

- Width: 29-7/8" (759 mm)
- Depth: 22-15/16" (582 mm)
- Thickness: 6" (152 mm)

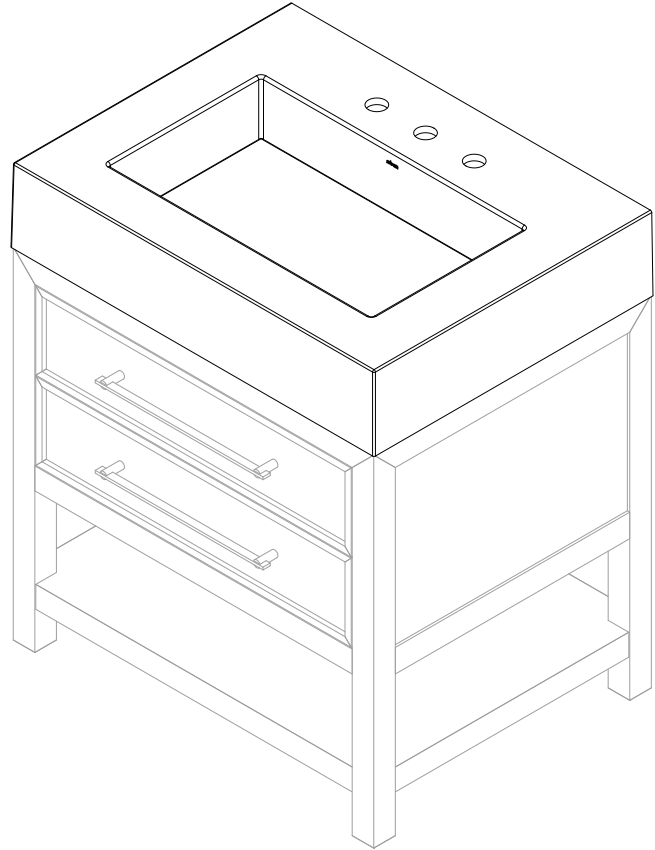

MODEL NUMBER KEY

<u>PRODUCT LINE</u>	<u>WIDTH</u>	<u>SINK TYPE</u>	<u>SINK LOCATION</u>	<u>OVERFLOW</u>	<u>FINISH COLOR</u>	<u>FAUCET PATTERN</u>
TA	30	M = Machined/Molded	C = Center	O = Overflow	(See above)	- 8CS8 = 8" (203 mm) Three Hole Spread

MORE INFORMATION

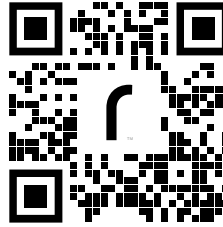

Scan the QR code to see the details found in the Craft Series Integrated Top installation instructions.

Use the camera app on your mobile device to look at this QR code. This will allow you to quickly access web pages and other relevant documents.

