

Craft Series Vanity
CVSE30 Sendai Vanity Specification Sheet

FEATURES

- Drawer fronts feature an integrated metal handle detail
- Richly textured oak finish
- Top drawer is a plumbing drawer
- Bottom drawer is a plumbing drawer
- Open shelf storage
- Removable glass drawer dividers included

MATERIALS & CONSTRUCTION

- Solid wood and veneer construction
- Full plywood back panel, no cutout
- Dovetailed drawers
- Blum full extension slow close drawer slides
- Durable, moisture resistant polyurethane finish
- Adjustable leveling feet

OPTIONS

- Available in:
 - CVSE3021587D - Matte Black Oak with Aged Brass
- Engineered stone tops available:
 - TA30UCO93-8CS1, White Zeus Extreme
 - TA30UCO95-8CS1, Eternal Marquina
 - TA30UCO96-8CS1, Pietra
 - TA30UCO97-8CS1, Calypso
 - TA30UCO98-8CS1, Eternal Serena
 - TA30UCO100-8CS1, Eternal Calacatta Gold
- Coordinating mirrors available
- Coordinating linen cabinet available

DIMENSIONS

- Width: 29" (736 mm)
- Height: 33-1/16" (839 mm)
- Depth: 22-5/8" (574 mm)

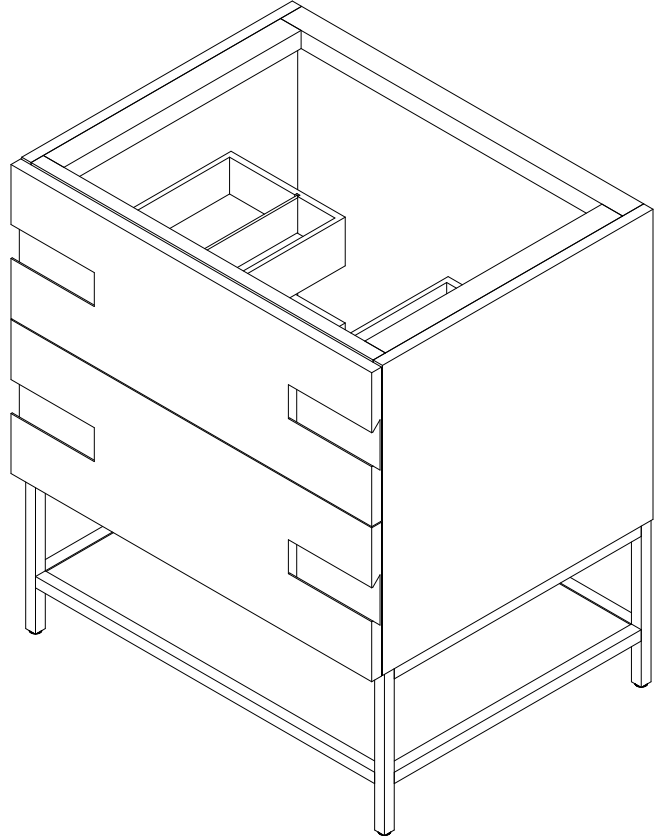

MODEL NUMBER KEY

PRODUCT LINE	CATEGORY	COLLECTION	WIDTH	FINISH OPTIONS
C = Craft Series	V = Vanity	SE = Sendai	30	(See above)

MORE INFORMATION

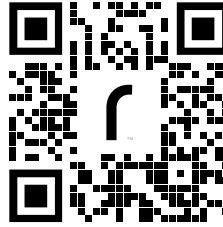

Scan the QR code to see the details found in the Craft Vanity installation instructions.

Use the camera app on your mobile device to look at this QR code. This will allow you to quickly access web pages and other relevant documents.

