

INLINE 2.0 LIGHTING
MLC36IKSSVC Specification Sheet

FEATURES

- Designed for easy, modular installation to M Series, M Series Reserve™, PL Series, and PL PORTRAY™ cabinets.
- Glass lens plane is flush with cabinet door.
- Lighting can range from warm, relaxing tones (2700K) to bright and energizing (5600K) or anything in between.
- Energy efficient LEDs.
- Requires the SWAY™ Wall Control (sold separately).
- Will operate in high humidity or damp spaces.
- Can be recessed or surface mounted (surface kit required)

Color Temperature	2700-5600K
CRI	90+
R9 Value	60-80+
Delivered Lumens	617-734
Source Lumens	1476-1745

MATERIALS & CONSTRUCTION

- Rust-free, aluminum and glass construction.
- Front frost mirror glass lens & satin anodized back frame.
- 6' Cat. 5 cable included for connection to SWAY™ control or additional Inline lights.
- Wired internally- Front access serviceability.
- Internal light diffuser evenly distributes light.

CODES & STANDARDS

- ETL certified (damp locations) to:
 - UL 8750
 - CSA C22.2 No. 250.13
- TITLE 24 certified

OPTIONS

Works with available cabinet mounting kits:

- Ganging kit
- Surface mount kit
- Semi-recess mount kit

DIMENSIONS

Width: 3-1/2" (89mm)
 Height: 36" (914mm)
 Recess Mounted Depth: 7/8" (22mm) when recessed
 Surface Mounted Depth: 4-5/8" (117mm) when surface mounted
 Net Weight: 5lbs

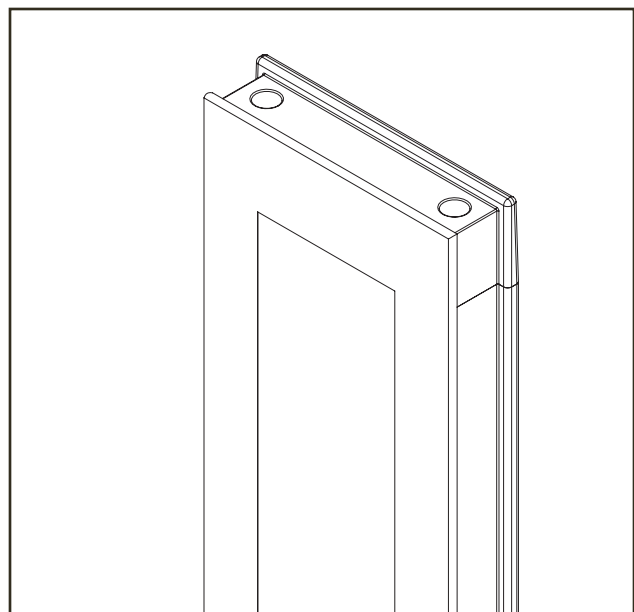

MODEL NUMBER KEY

Product Line	Category	Dimensions	Body Type	Lamp Type	Qty.	Body Finish	Control Type
ML =Inline	2.0 Light	C36 = 3-1/2" (89mm) X 36" (914mm)	I = Inline 2.0	K = T24 LED	S = Single	S = Satin Anodized	VC = Tunable:Dimming to 5%, Color Temperature Tuning (2700K-5600K)

INSTALLATION

- Sold as individual unit.
- Fixture adds 3-1/2" per light (7" pair) to the overall rough-in width.
- Inline Lighting includes hardware to mount to cabinet.
- Ganging kit is required when ganging more than one cabinet. Can be surface mounted with 4" depth (D4) and 6" depth (D6) cabinets (D4 and D6 surface mount kits required). Can be semi-recessed with 6" depth (D6) cabinets (D6 semi-recessed kit required). Can also be fully recessed with 4" depth (D4) and 6" depth (D6) cabinets.

ELECTRICAL SYSTEM

- Operates on 120VAC 60Hz per fixture.
- Requires SWAY™ Control (sold separately).
- ETL (US and Canada) listed for damp locations.
- Recommended field wire and cat. 5 locations as shown in

MORE INFORMATION

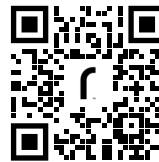

Scan the QR code to see the rough opening and electrical details found in the Inline 2.0 Light installation instructions.

Use the camera app on your mobile device to look at this QR code. This will allow you to quickly access web pages and other relevant documents.

