

INLINE 2.0 LIGHTING
MLC36IKSS3D Specification Sheet

FEATURES

- Designed for easy, modular installation to M Series, M Series Reserve™, PL Series, and PL PORTRAY™ cabinets.
- Glass lens plane is flush with cabinet door.
- Warm white 3000K light
- Energy efficient LEDs.
- Dimmable LED using a standard residential dimmer that works with your home's existing wiring.
- Will operate in high humidity or damp spaces.
- Can be recessed or surface mounted (surface kit required)

Color Temperature	3000K
CRI	90+
R9 Value	80+
Delivered Lumens	671
Source Lumens	1521

MATERIALS & CONSTRUCTION

- Rust-free, aluminum and glass construction.
- Satin Anodized back frame.
- Front frosted mirror glass lens.
- Wired internally- Front access serviceability.
- Internal light diffuser evenly distributes light.

CODES & STANDARDS

- ETL certified (damp locations) to:
 - UL 8750
 - CSA C22.2 No. 250.13
- TITLE 24 certified

OPTIONS

Works with available cabinet mounting kits:

- Ganging kit
- Surface mount kit
- Semi-recess mount kit

DIMENSIONS

Width: 3-1/2" (89mm)
 Height: 36" (914mm)
 Recess Mounted Depth: 7/8" (22mm) when recessed
 Surface Mounted Depth: 4-5/8" (117mm) when surface mounted
 Net Weight: 5lbs

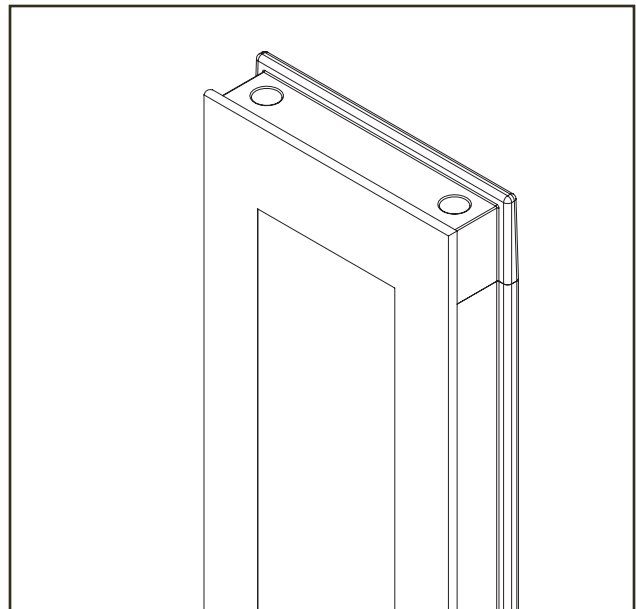

MODEL NUMBER KEY

Product Line	Category	Dimensions	Body Type	Lamp Type	Qty.	Body Finish	Control Type
ML =Inline	2.0 Light	C36 = 3-1/2" (89mm) X 36" (914mm)	I = Inline 2.0	K = T24 LED	S = Single	S = Satin Anodized	3D = Dimmable , Dimming to 5%, Warm White 3000K

INSTALLATION

- Sold as individual unit.
- Fixture adds 3-1/2" per light (7" pair) to the overall rough-in width.
- Inline Lighting includes hardware to mount to cabinet.
- Ganging kit is required when ganging more than one cabinet. Can be surface mounted with 4" depth (D4) and 6" depth (D6) cabinets (D4 and D6 surface mount kits required). Can be semi-recessed with 6" depth (D6) cabinets (D6 semi-recessed kit required). Can also be fully recessed with 4" depth (D4) and 6" depth (D6) cabinets.

ELECTRICAL SYSTEM

- Operates on 120VAC 102.6W 60Hz per fixture.
- Requires switch or dimmer (sold separately).
- ETL (US and Canada) listed for damp locations.
- Recommended field wire locations as shown in drawing.

MORE INFORMATION

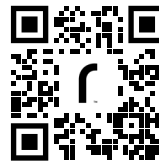

Scan the QR code to see the rough opening and electrical details found in the Inline 2.0 Light installation instructions.

Use the camera app on your mobile device to look at this QR code. This will allow you to quickly access web pages and other relevant documents.

