

Features

- Modular Cabinet - combine multiple cabinets, lighting, or mirrors
- All cabinets are non-handed/reversible
- Mirrored interior with 4 adjustable, cantilevered glass shelves
- Cantilever shelving adjustable in 1" increments
- Includes installation hardware for recess mounting
- Can be recessed or surface mounted (surface mounting kit required)

Optional Features & Upgrades

- PORTRAY Quick Caddy (QUICKCADDY)
 - PORTRAY Electric Upgrade (P2ELECTRIC)
 - PORTRAY Sliding Magnification Mirror available for 16", 20", and 24" widths*
 - Blum 110° slow close hinges
 - Polished edge or 3/4" beveled front mirror
 - Modular design with multiple installation options (See options below).
 - Other widths/heights available ranging 12" to 24" wide, 20" to 72" high
 - Glass Bins (GLASSBIN3.25, GLASSBIN5.25, GLASSBIN8.5)
- * This accessory cannot be added post-sale.

Construction

- Rust free Satin anodized aluminum construction
- Blum hinges standard
- 3 mirror design - rear of cabinet and both sides of door

Codes/Standards Applicable

- Electric Option Models are ETL certified to:
 - UL 962
 - CSA Standard C22.2 No. 68

Dimensions

Width: 23-1/4" (591 mm)
 Height: 39-3/8" (1000 mm)
 Depth: 4-5/8" (117 mm) When surface mounted
 7/8" (22 mm) When recessed

Installation Options

Recessed Mount - Rough Opening - 22-1/2" W x 38-5/8" H x 4" D (572 mm W x 981 mm H x 102 mm D)

Surface Mount (Single Cabinet) - Reference Surface Mount Kit when ordering (P2SMKIT)

Pairs with Modular mirrors

Gangs to PL PORTRAY Series Cabinet - Reference PL PORTRAY Ganging Kit when ordering (P2RMGKIT, P2SM-GKIT)

Gangs to Lighting* - Reference Ganging kit for the particular light option when ordering.

* Compatible with Vesper, InLine, Profiles, M Series, PL Series, AiO Cabinet, Vitality Cabinet

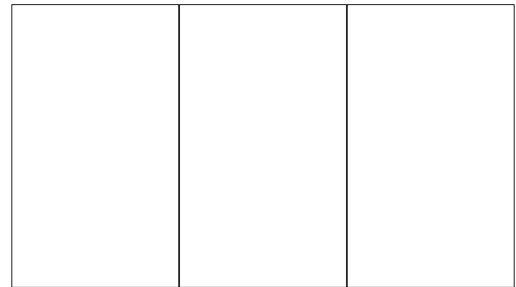
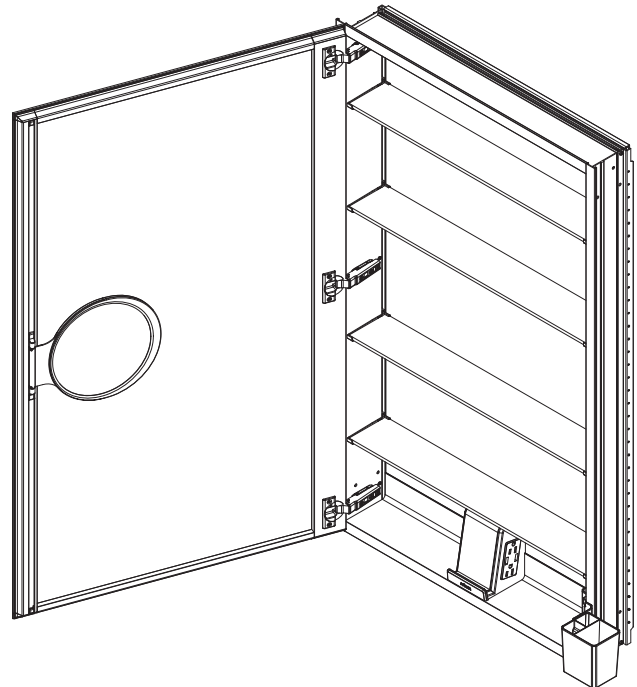

Ganging Cabinet-to-Cabinet Arrangement

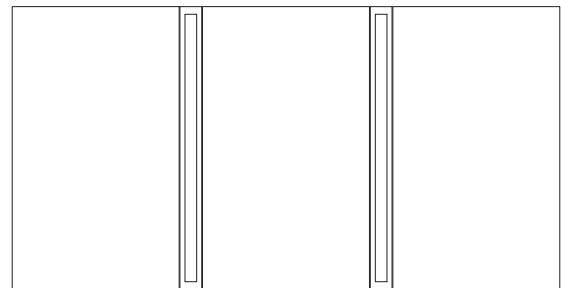

Ganging Cabinet-to-Lights Arrangement

Model Number Key

PL PORTRAY Series	Width	Height	Depth	Mirror Edge Style	Upgrade Option	
P2C	24	40	D4	FP = Polished Edge	BA = No Upgrade	FS = Storage Upgrade
				FB = Bevel Edge	SC = Slow Close Upgrade	TU = Electric Upgrade
					MM = Magnification Mirror Upgrade	FT = Storage and Electric Upgrade

Electrical System

- 120 VAC 60HZ 20A
- Field wire location as shown in drawing
- 1/2" conduit (Ø 7/8" actual) electrical knockout location shown below

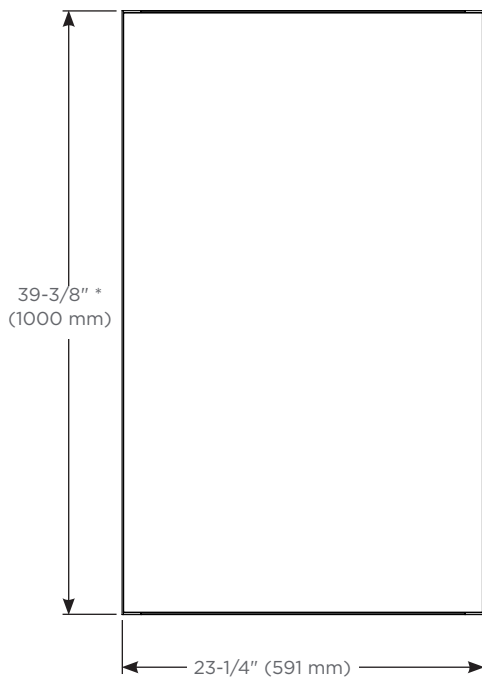
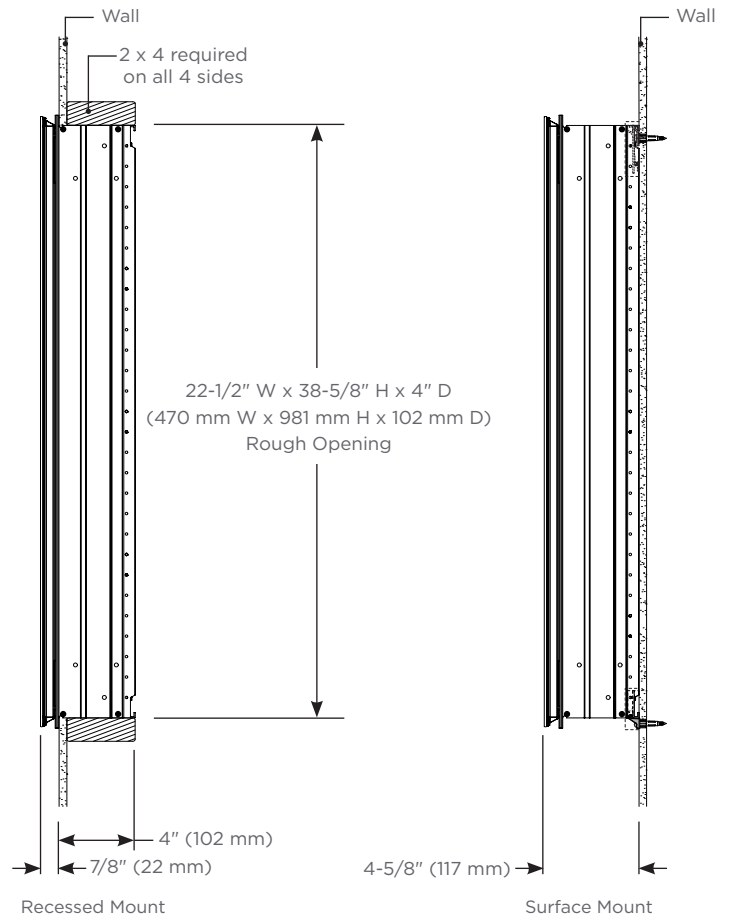

Cabinet Dimensions

*Door is 1/8" (3 mm) smaller than cabinet

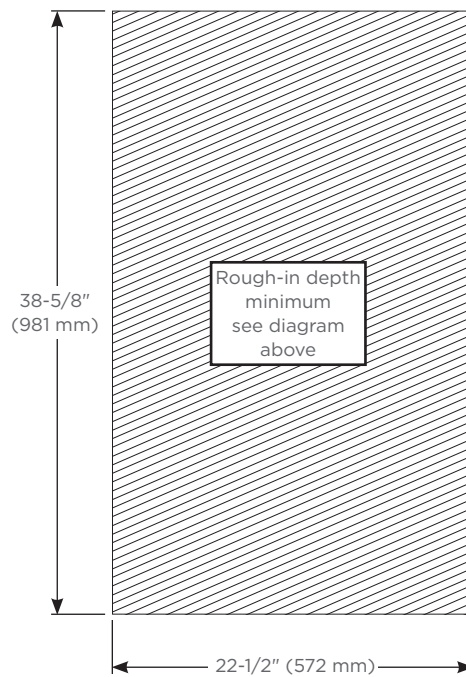

Rough-in Dimensions

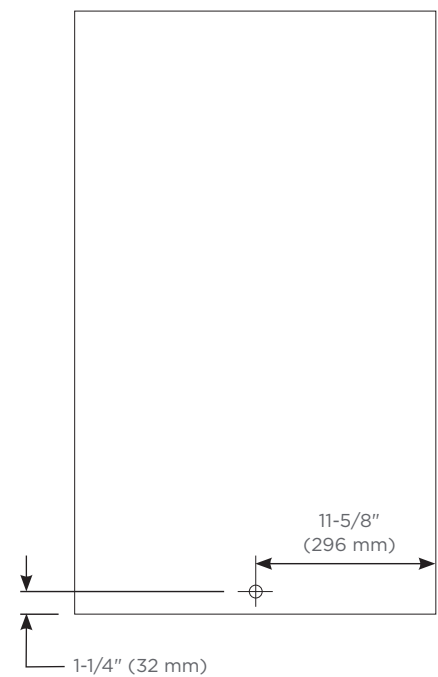

Back of Cabinet - Wire Access Location