

INSTALLATION INSTRUCTIONS

FULL EXTENSION SLIDE WITH BASKET / WINE RACKS / SPICE RACKS

TOOLS REQUIRED:

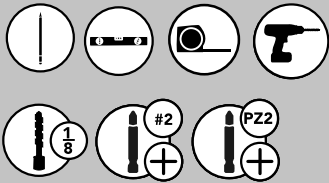

ESTIMATED ASSEMBLY TIME:

20 MIN

CARE AND MAINTENANCE:

Clean with a damp cloth and wipe parts dry.

WATCH TUTORIALS OF OUR PRODUCTS BEING INSTALLED



WWW.REV-A-SHELF.COM/VIDEOS



PARTS LIST

No.	Description	Qty.*
A	M6 x 6 mm Flat Head Euro Screws	4, 12, or 20
B	#8-32 X 1/2" Flat Head Screws	4, 12, or 20
C	Pair of Slides	1, 3, or 5
D	Basket/ Wine Rack / Spice Rack	1, 3, or 5
E	Slide Bumpers	2, 6, or 10

*Quantity depends on unit purchased

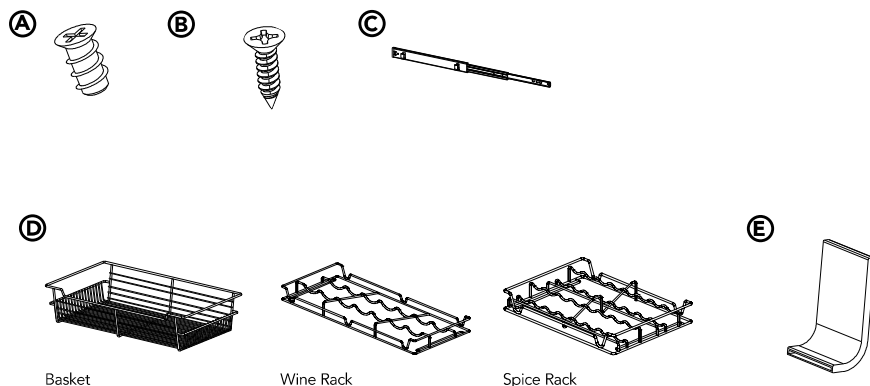

Basket

Wine Rack

Spice Rack

STEP 1

Disengage the slides by pushing the black release lever that is located on the inner member slide from the outer member slide. Pull the inner member slide as the black push lever is released (See Figure 1).

FIG. 1

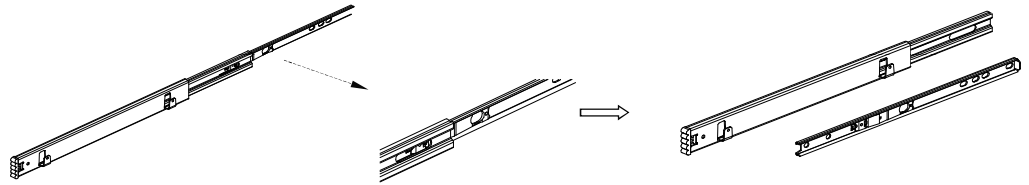

STEP 2

Install the inner member slides to the sides of the panels in the desired location using the (4) M6 x 6 mm screws, if installing using 32 mm system holes or use the (4) #8-32 x 1/2" screws for other applications (See Figure 2).

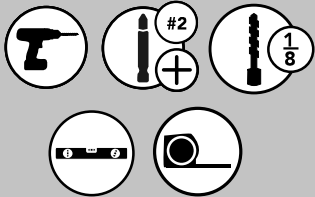
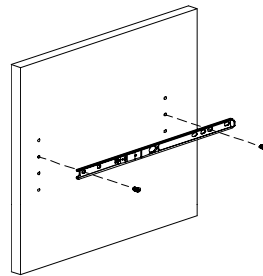
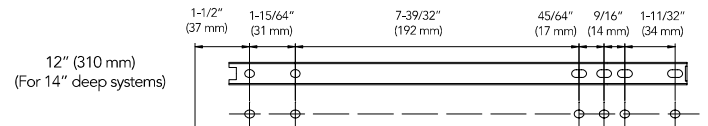

FIG. 2



Cabinet Front Edge



STEP 3

Slide the outer slide member onto the inner slide member. You will hear a click when the slides are re-engaged. (See Figure 3).

FIG. 3

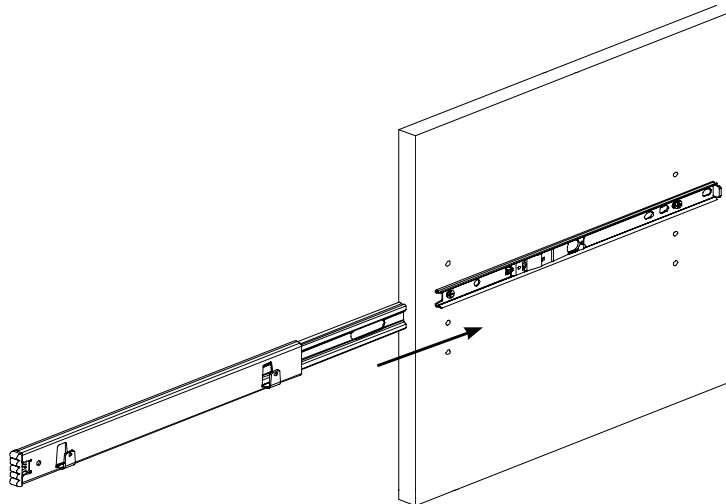

STEP 4

Slide the slide bumpers over the (2) basket mounting hooks on each slide (See Figure 4).

FIG. 4

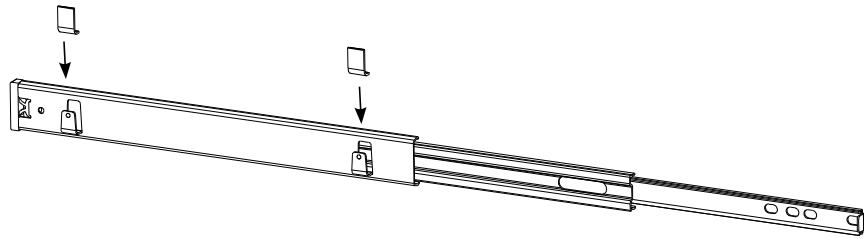

STEP 5

Place the basket / wine rack / spice rack onto the mounting hooks (See Figure 5).

Note: Mount the basket / wine rack / spice rack on the second wire. Front to back placement is based on your personal preference.

FIG. 5

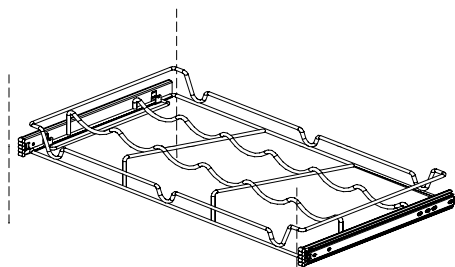
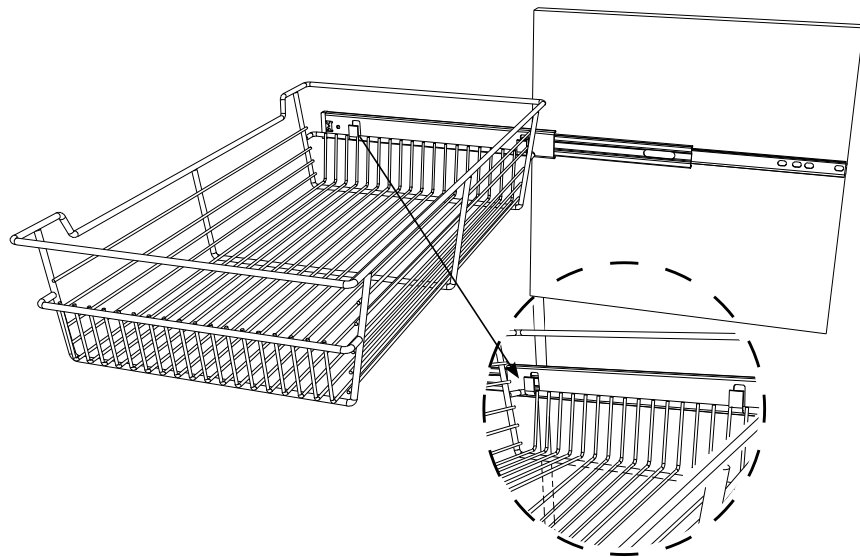

Wine Rack

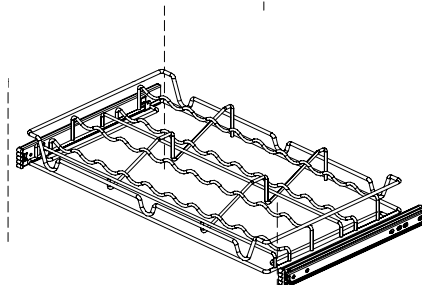

Spice Rack



 **REV·A·SHELF**[®]
Innovation through Organization™

12400 Earl Jones Way
Louisville, KY 40299
rev-a-shelf.com
Customer Service: 800-626-1126

INSTRUCCIONES DE INSTALACIÓN / INSTRUCTIONS D'INSTALLATION

CORREDERA DE EXTENSIÓN COMPLETA CON CESTA / ESTANTE PARA VINOS / ESTANTE PARA ESPECIAS
GLISSIÈRE À EXTENSION COMPLÈTE AVEC PANIER/ÉTAGÈRES À VIN/ÉTAGÈRE À ÉPICES

Herramientas requeridas:
Outils Requis:

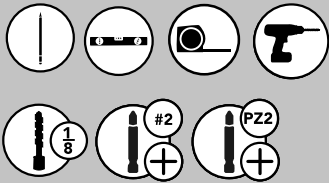

Tiempo estimado de ensamblado:
Durée de l'installation:

20 MIN

CUIDADO/ ENTRETIEN:

Limpie con un paño húmedo y seque las partes.

Nettoyez avec un linge humide et essuyez les pièces pour les secher complètement.

VER VIDEOS DE
INSTALACIONES DE PRODUCTOS
*REGARDER DES VIDÉOS
D'INSTALLATIONS DE PRODUITS*



WWW.REV-A-SHELF.COM/VIDEOS



LISTA DE PARTES / LISTE DES PIÈCES

No.	Descripción / Description	Qty.*
A	Tornillos Euro de cabeza plana M6 x 6 mm <i>M6 x 6 mm vis Euro à tête plate</i>	4, 12, or 20
B	Tornillos de cabeza plana #8 32 X 1/2" <i>#8-32 X 1/2 po vis à tête plate</i>	4, 12, or 20
C	Par de correderas / Une paire de glissières	1, 3, or 5
D	Cesta / Estante para vinos / Estante para especias <i>Panier/étagère à vin/étagère à épices</i>	1, 3, or 5
E	Topes de corredera / Pare-chocs de la glissière	2, 6, or 10

*La cantidad depende de la unidad comprada / *La quantité dépend de l'unité achetée

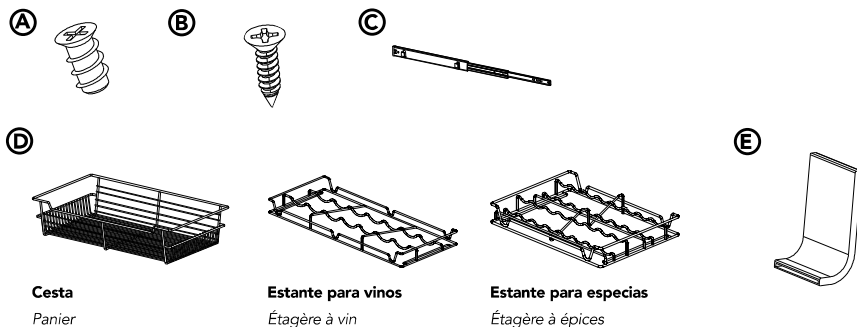

PASO 1 / ÉTAPE 1

Desenganche las correderas empujando la pestaña negra de liberación que se encuentra en la parte interna hacia la parte externa de la corredera. Tire de la corredera de la pieza interior mientras se libera la pestaña negra de empuje (ver figura 1).

Désengager les glissières en poussant le levier de libération noir qui est situé sur la glissière du membre interne de la glissière du membre externe. Tirer la glissière du membre interne alors que le levier de poussée est libéré (voir Figure 1).

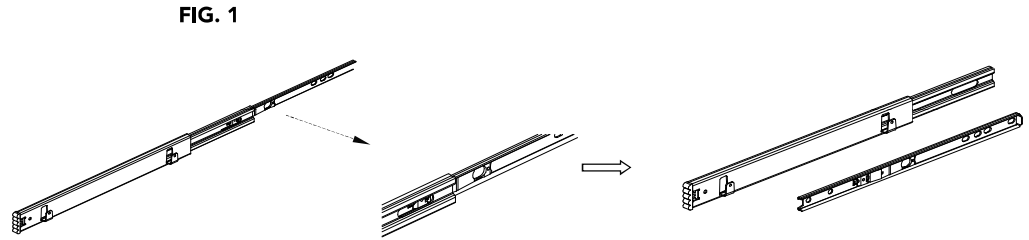

FIG. 1

PASO 2 / ÉTAPE 2

Instale las correderas de la pieza interior a los lados de los paneles en la ubicación deseada utilizando cuatro (4) tornillos M6 x 6 mm, si se está instalando con orificios del sistema de 32 mm o usa los (4) tornillos #8 32 x 1/2" para otras aplicaciones (ver figura 2).

Installer les glissières du membre interne sur les côtés des panneaux à l'endroit désiré en utilisant les (4) vis M6 x 6 mm si installation avec les trous de 32 mm du système ou utiliser les (4) vis #8-32 x 1/2 po pour les autres applications (voir Figure 2).

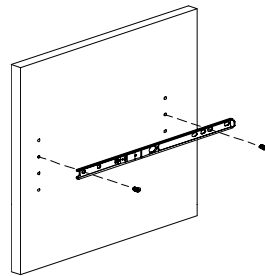

FIG. 2

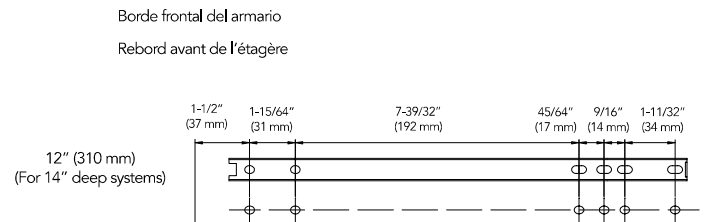
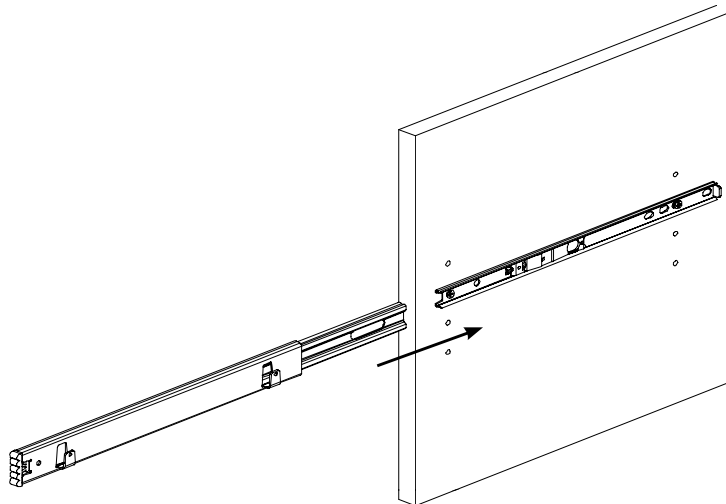

FIG. 3

PASO 3 / ÉTAPE 3

Deslice la pieza externa sobre la pieza interna de la corredera. Oirá un clic cuando las correderas se vuelvan a encajar (ver figura 3).

Glisser le membre externe de la glissière sur le membre interne de la glissière. Vous entendrez un clic lorsque les glissières sont engagées de nouveau (voir Figure 3).



PASO 4 / ÉTAPE 4

Deslice los topes de las correderas sobre los (2) ganchos de montaje de la cesta en cada corredera (ver figura 4).

Glisser les pare-chocs des glissières sur les (2) crochets de montage du panier des deux côtés (voir Figure 4).

FIG. 4

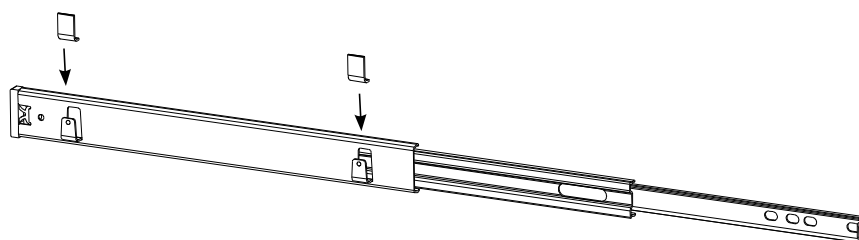

FIG. 5

Coloque la cesta / el estante para vinos / el estante para especias en los ganchos de montaje (ver figura 5).

Nota: Monte la cesta / el estante para vinos / el estante para especias en el segundo cable. El posicionamiento de adelante hacia atrás se basa en su preferencia personal.

Placer le panier/étagère à vin/étagère à épices sur les crochets de montage (voir Figure 5).

Remarque : Monter le panier/étagère à vin/étagère à épices sur le second fil. Le positionnement d'avant vers l'arrière est basé sur votre préférence personnelle.

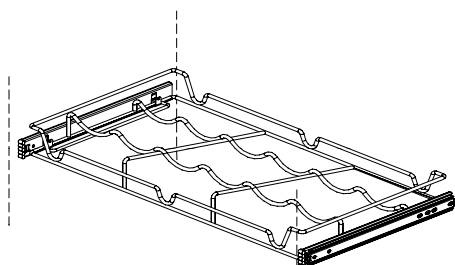
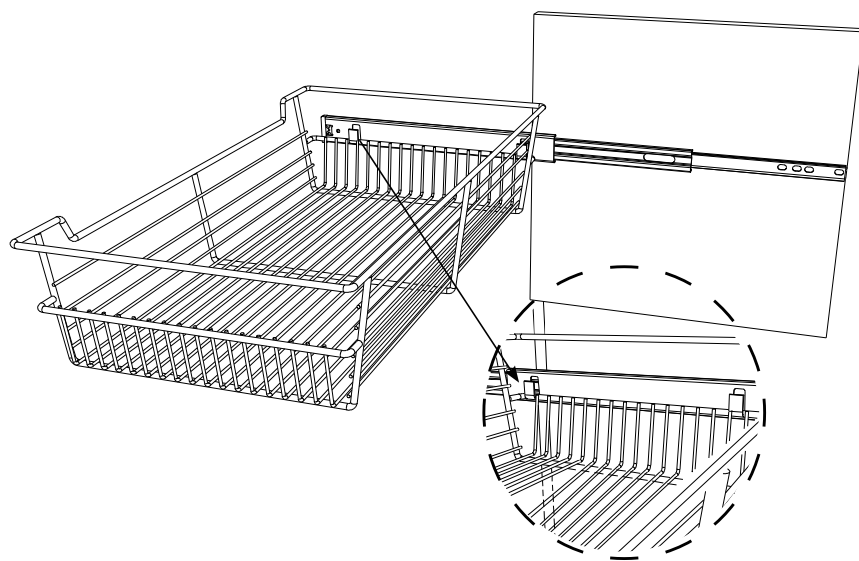

Estante para vinos
Étagère à vin

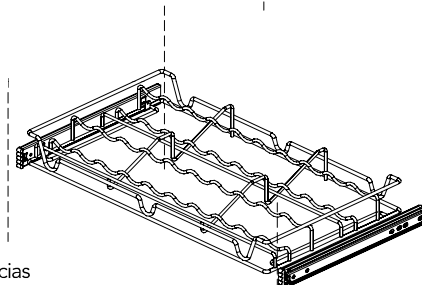

Estante para especias
Étagère à épices



 **REV·A·SHELF**[®]
Innovation through Organization™

12400 Earl Jones Way
Louisville, KY 40299
rev-a-shelf.com
Customer Service: 800-626-1126