

Please go to [www.quoizel.com](http://www.quoizel.com) for product cleaning tips. Go to the **Care + Maintenance** selection.

**Tools Required:** Flathead screwdriver, Phillips screwdriver, pliers, wire cutters, wire strippers, electrical tape, safety glasses.

**Light Source:** (6) Medium Base Decorative Filament 60W bulbs (provided), Maximum 100W, Alternate bulb (6) 23W CFL Maximum.

**Estimated Assembly Time:** 30-45 minutes

**Preparation:** Identify and inspect all parts before beginning installation. Check package content list and diagrams below to be sure all parts are present. If any parts are missing or damaged, do not attempt to assemble, install, or operate the fixture. Contact customer service for replacement parts.

**⚠ Warnings and Cautions**

Turn off electricity at circuit breaker or main fuse box before installation. Consult a licensed electrician if in doubt.

These instructions are provided for your safety. It is very important you read them completely before installing the fixture. We strongly recommend that a licensed, professional electrician perform the installation.

Disconnect fixture from power source before replacing bulbs. Make sure bulbs are given sufficient time to cool before removal. Do not subject glass parts to any shock while in operation or shattering may result.

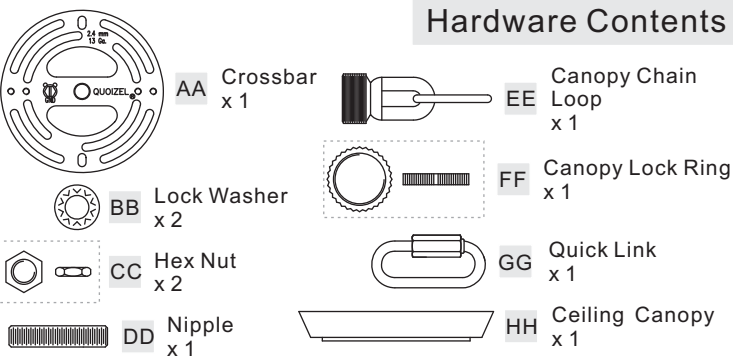
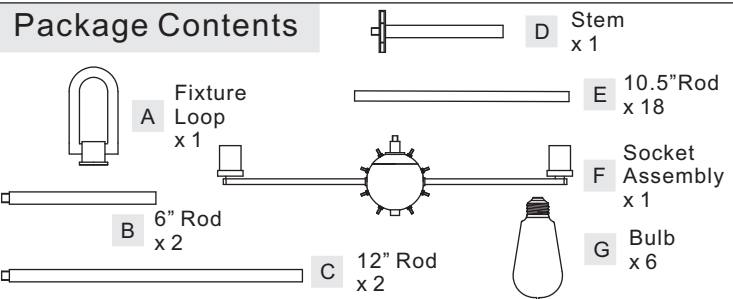

**STEP 1 – Assemble the Rods and the Fixture Loop**

- Thread Stem (D) onto the nipple on the top of Socket Assembly (F), hand tighten until snug.
- Determine the Rods (B/C) to be assembled to the Socket Assembly (F) according to your hanging height.
- Pass the supply wires and ground wire through the chosen rods (B/C) and the Fixture Loop (A). Thread the Socket Assembly (F), the chosen Rods (B/C) and the Fixture Loop (A) together. Hand tighten until snug. Suggested rods for Ceiling height :  
8' ceiling : use (1)6" rod and (1)12" rod  
9' ceiling : use (1)6" rod and (2)12" rods  
10' ceiling: use (2)6" rods and (2)12" rods

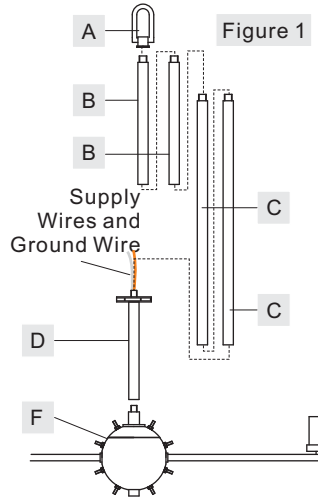

**STEP 2 – Install Crossbar, Canopy Chain Loop and Nipple**

- \* Pliers is required for this step.
- A. Attach the Crossbar (AA) to the Outlet Box with the head of the Green Ground Screw facing you. Secure it with Outlet Box Screws (not included). Tighten until snug.
- B. Thread one Hex Nut (CC) to one end of the Nipple (DD) until it is at least 0.25" from the end. Pass one Lock Washer (BB) over the end of the Nipple (DD) and thread the Canopy Chain Loop (EE) onto the Nipple (DD). By using pliers, thread the Hex Nut (CC) against the Canopy Chain Loop (EE) and hand tighten until snug.
- C. Thread another Hex Nut (CC) to the middle of the Nipple (DD). Place another Lock Washer (BB) over the Nipple (DD) and then thread the Nipple (DD) into the Crossbar (AA) until the Nipple (DD) is about 0.375" above the Crossbar (AA).
- D. Remove the Canopy Lock Ring (FF) from the Canopy Chain Loop (EE). Place the Ceiling Canopy (HH) over the Canopy Chain Loop (EE) against the ceiling to determine the correct position of the Nipple (DD). Thread the Canopy Lock Ring onto the Canopy Chain Loop (EE). Adjust the Nipple (DD) to allow the Ceiling Canopy (HH) to rest against the ceiling when held in place by the Canopy Lock Ring (FF).
- E. Remove the Canopy Lock Ring (FF) and the Ceiling Canopy (HH). Tighten the Hex Nut (CC) against the Crossbar (AA) to secure in place.

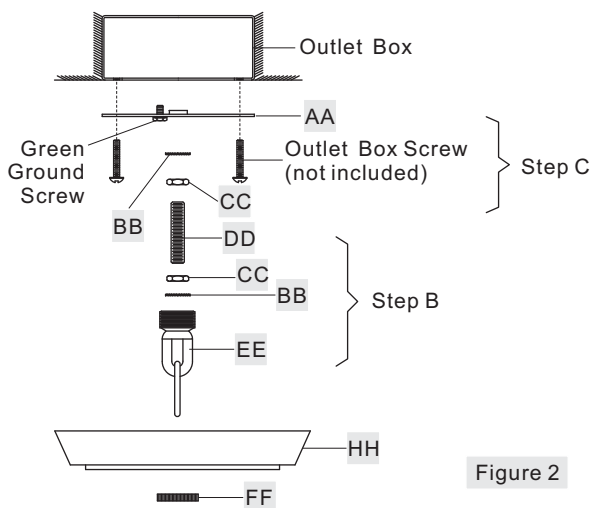

**STEP 3 - Install Fixture Chain and Ceiling Canopy**

- With the Quick Link (GG) not attached to the Fixture Loop (A) and the Canopy Chain Loop (EE), pull the supply wires through the Canopy

**Thank you for purchasing a Quoizel product.  
Need assistance with parts or assembly? Call Quoizel customer service at 1-631-273-2700  
or visit us on-line at [www.quoizel.com](http://www.quoizel.com)**

Lock Ring (FF), the Ceiling Canopy (HH) and the Quick Link (GG) in order.

B. Connect the Fixture Loop (A) to the Canopy Chain Loop (EE) with the Quick Link (GG).

C. Feed the Supply Wires and Ground Wire through the Canopy Chain Loop (EE) and Nipple (DD) into the Outlet Box. Cut the wires leaving approximately 8" of wire extending from the Outlet Box.

D. Refer to Step 4 for wire connections.

F. Raise the Ceiling Canopy (HH) and Canopy Lock Ring (FF) up the Quick Link (GG) and over the Canopy Chain Loop (EE). Tighten the Canopy Lock Ring (FF) onto the Canopy Chain Loop (EE) until tight.

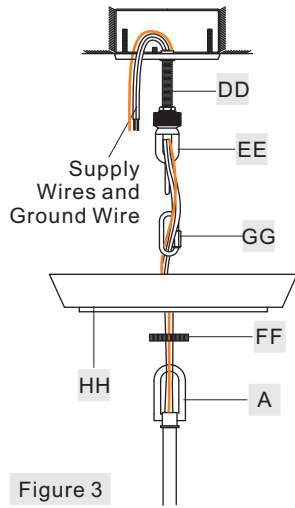

Figure 3

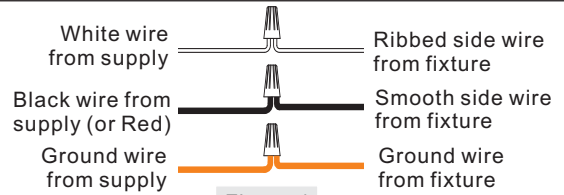

Figure 4

### STEP 5 - Install Bulb and Shade

A. Thread 10.5" Rod (E) onto the Bolt on the Socket Assembly (F). Hand tighten until snug.

B. This fixture uses Medium Base Decorative Filament 60W bulb (G), Maximum 100W. Insert bulb and screw snugly into place.

C. Insert bulb and screw properly into place.

Your fixture is now assembled and ready to use. Enjoy!

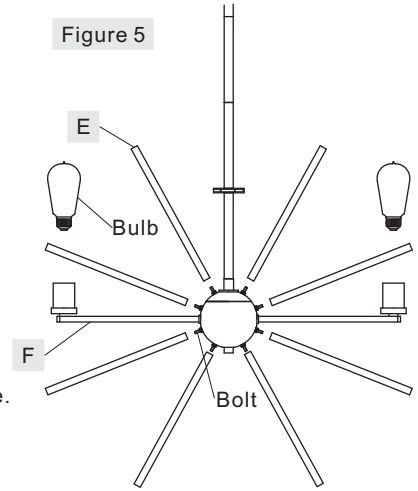

Figure 5

### STEP 4 - Wire Connections

A. Use standard wire connectors (not included) to make all wire connections. (Connectors are not included with fixture.) Twist connectors until wires are tightly joined together. Wrap each connection with approved electrical tape and carefully stuff all the connected wires into the Outlet Box.

UPCN5006WT/UPCN5006IS

FINISH: WESTERN BRONZE  
IMPERIAL SILVER

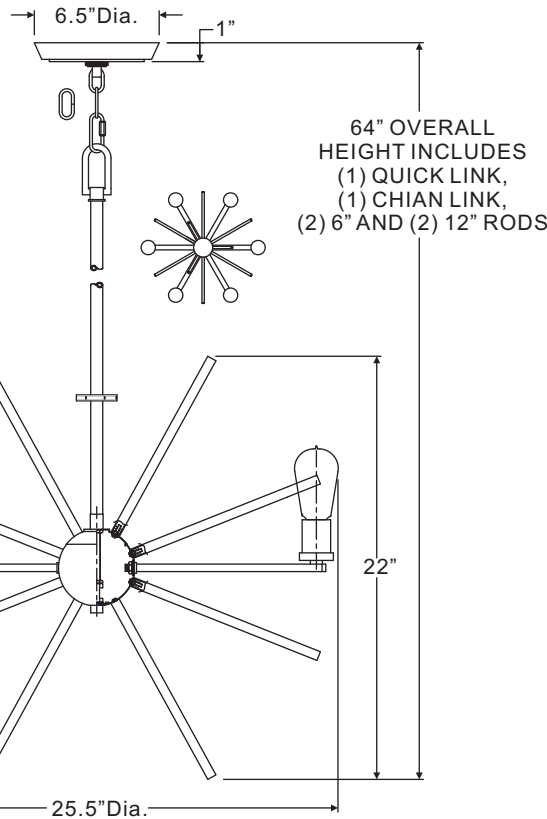
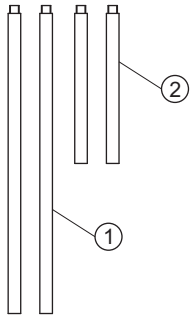

(6) Medium Base Decorative Filament 60W bulbs (provided), Maximum 100W.

NOTE: ALL DIMENSIONS ARE ROUNDED UP TO THE NEAREST 1/2"

NO.	PART NUMBER	REPLACEMENT PART	REQ.	STYLE NUMBER	NO.	PART NUMBER	REPLACEMENT PART	REQ.	STYLE NUMBER
1	9008EXWT	ROD 12"L	2	UPCN5006WT	1	9008EXIS	ROD 12"L	2	UPCN5006IS
2	9007EXWT	ROD 6"L	2		2	9007EXIS	ROD 6"L	2	
3	I1101EC	VINTAGE BULB	6	UPCN5006WT, UPCN5006IS					

Thank you for purchasing a Quoizel product.  
Need assistance with parts or assembly? Call Quoizel customer service at 1-631-273-2700  
or visit us on-line at [www.quoise.com](http://www.quoise.com)