

Tools Required

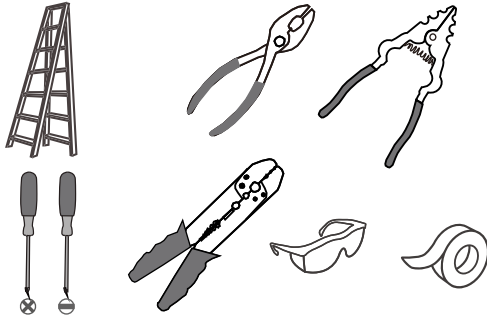

Light Source

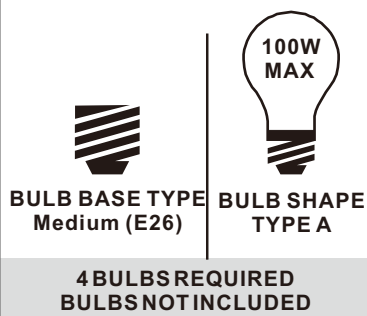

**Fixture Height Adjustable
12" to 67"**

Warnings and Cautions

Turn off the electricity at the circuit breaker before installation. Consult a licensed electrician if in doubt about installation.

Turn off power to the fixture and allow the bulbs to cool before replacing.

Package Contents

Preparation: Identify and inspect all parts before beginning the installation.

Missing or damaged parts? Contact your original place of purchase.

PARTS BAG

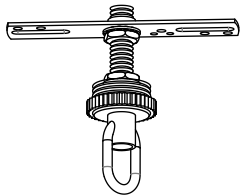

A Crossbar Assembly x 1



B Outlet Box Screw x 2

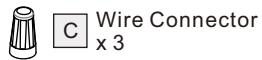

C Wire Connector x 3

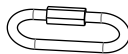

D Quick Link x 2

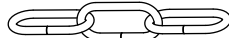

E Fixture Chain x 1

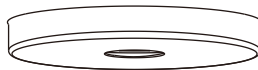

F Ceiling Canopy x 1

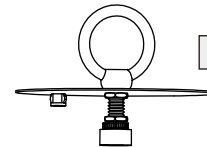

G Fixture Loop Assembly x 1

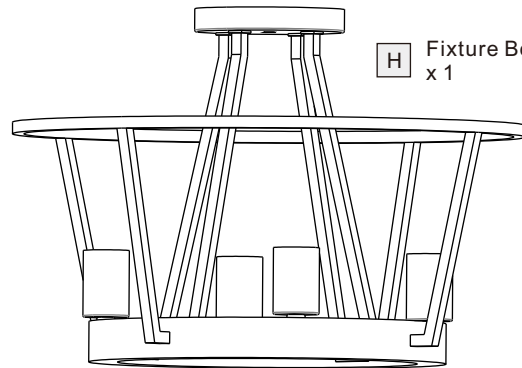

H Fixture Body x 1

Table of Contents

**Assembly Instructions for Chandelier Light
(Step 1A - Step 5A)**

BRT2817GK, BRT2817BSR

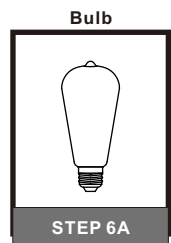
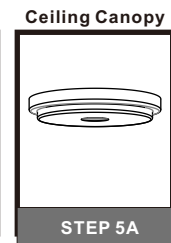
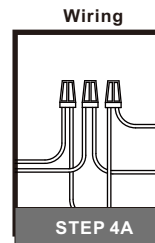
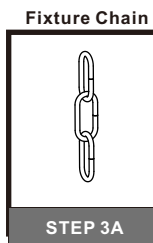
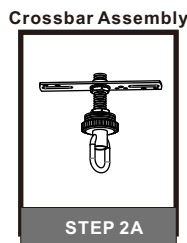
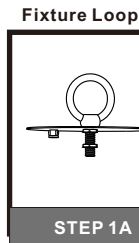

**Assembly Instructions for Semi-flush Light
(Step 1B - Step 4B)**

BRT1717GK, BRT1717BSR

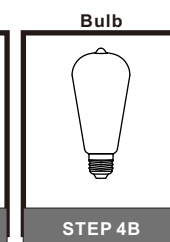
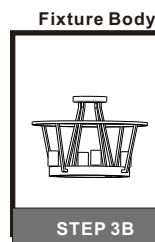
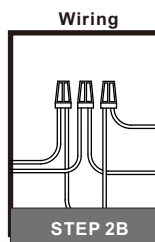
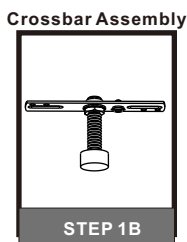

STEP 1A

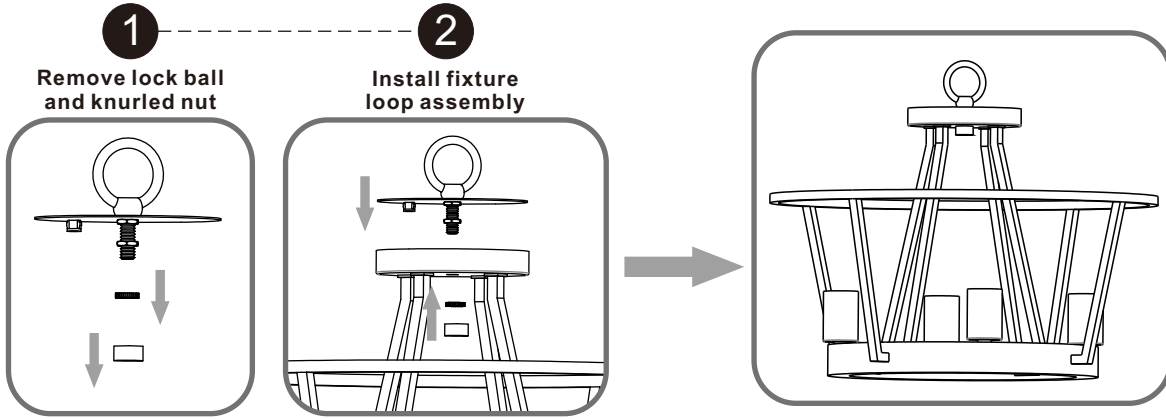

STEP 2A

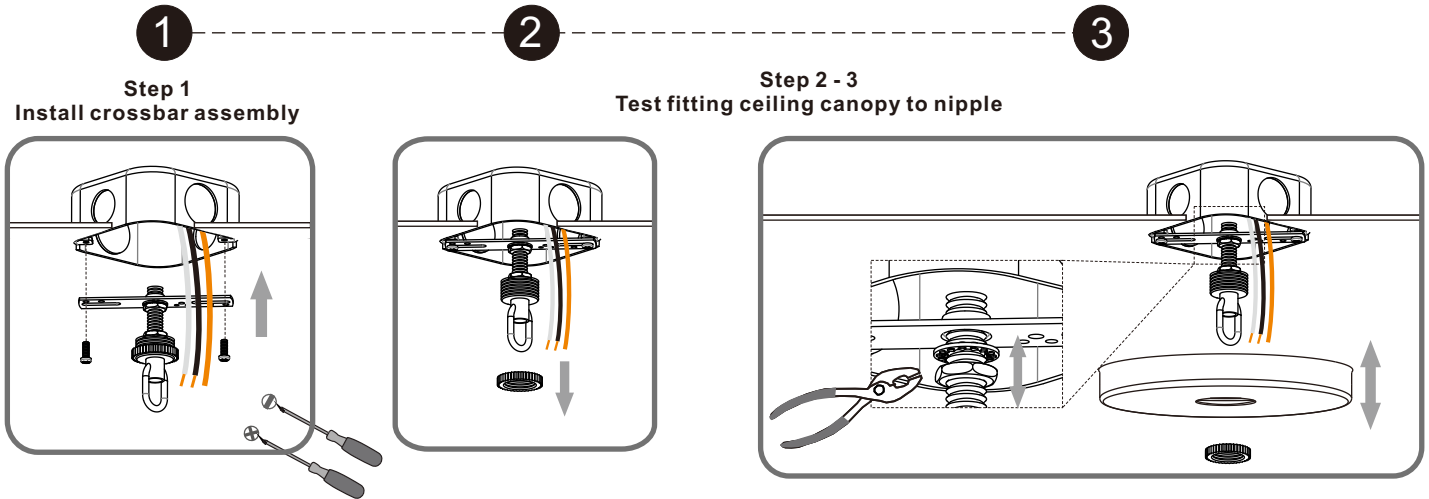

STEP 3A

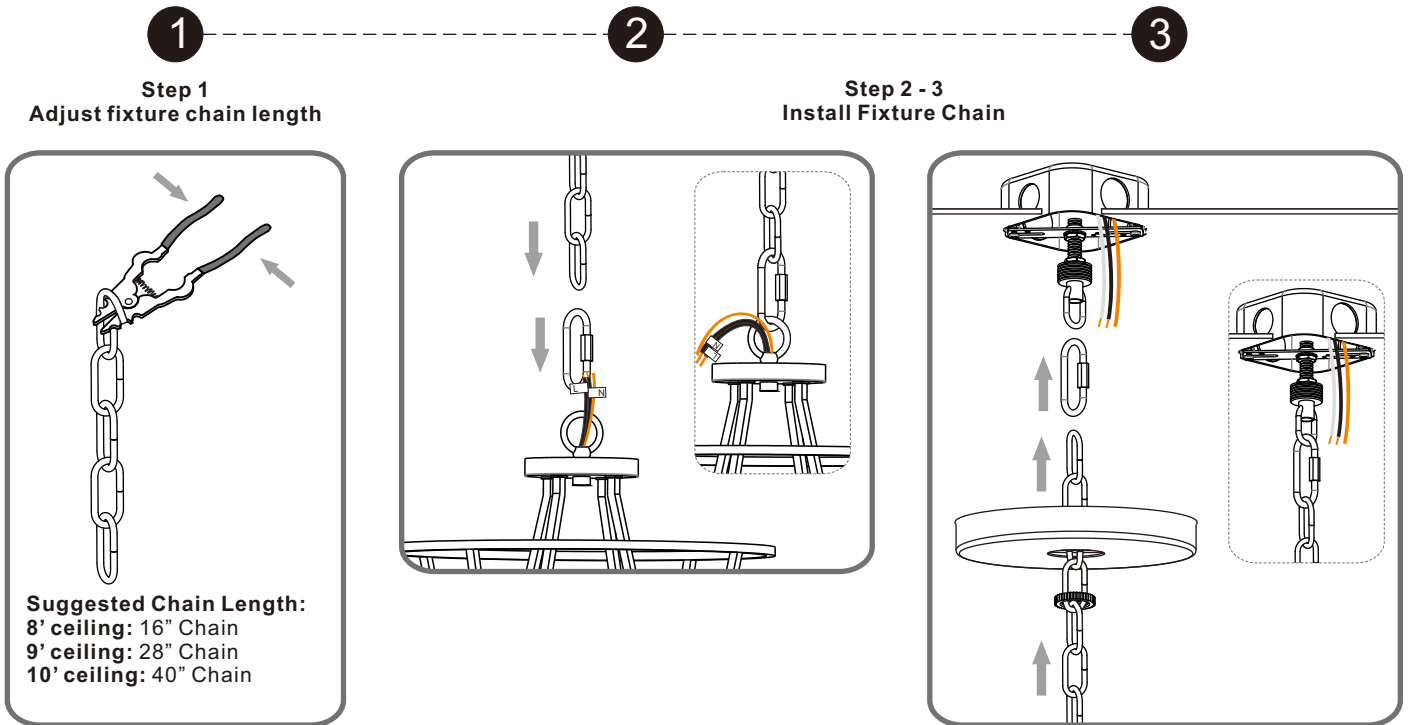

STEP 4A

1

Step 1
Feed the fixture wires
through the loop

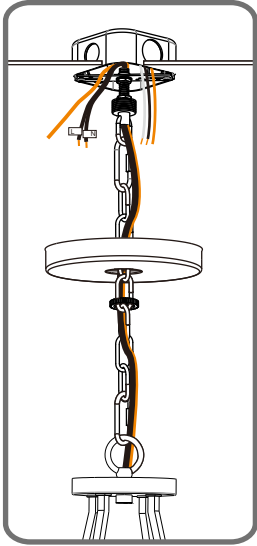

2

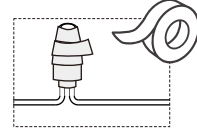
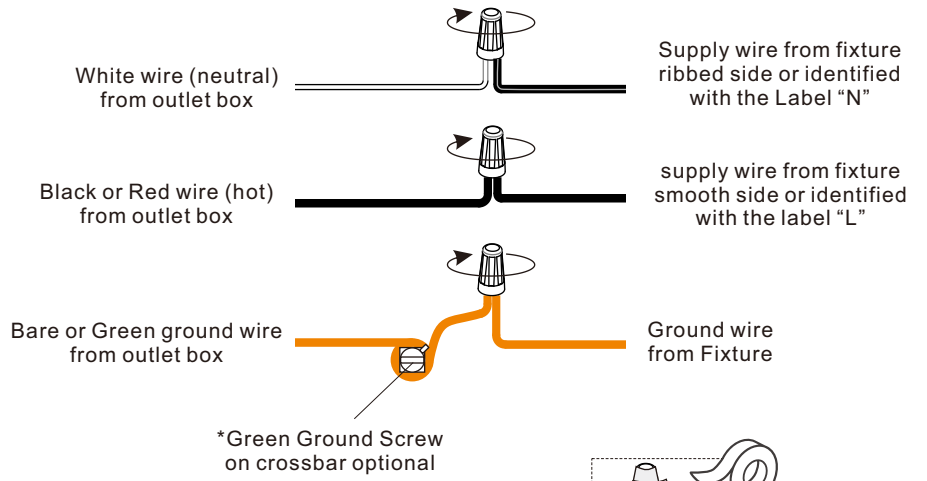

STEP 5A

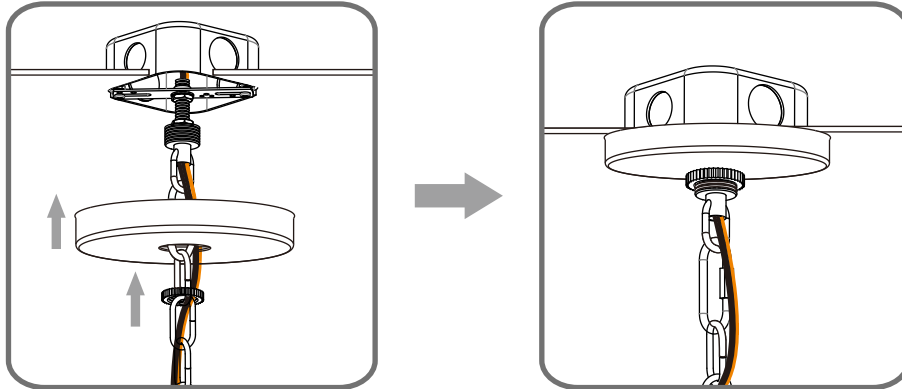

STEP 6A

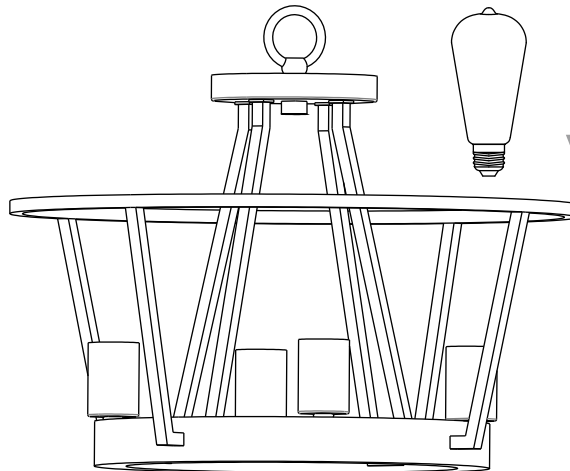

STEP 1B

1

Remove canopy chain loop, one lock washer and one hex nut

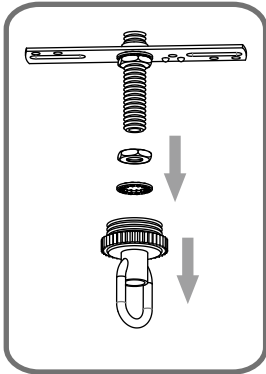

2

Install crossbar assembly

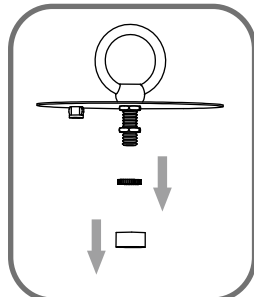
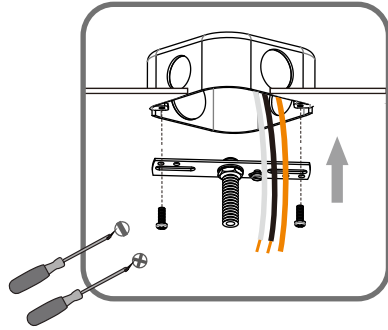

Remove lock ball and knurled nut

3

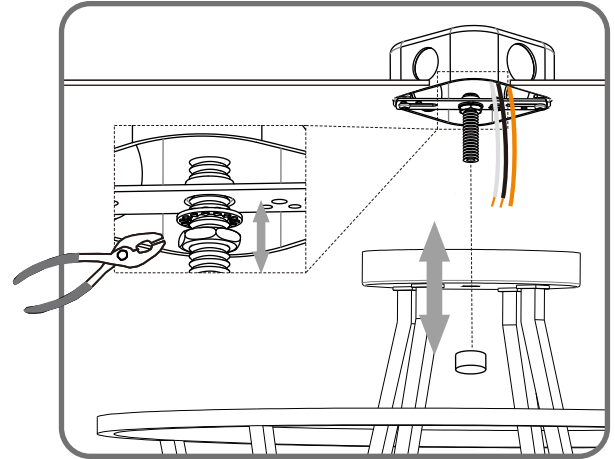

Test fitting ceiling canopy to nipple

4

STEP 2B

1

Step 1
Cut supply wires

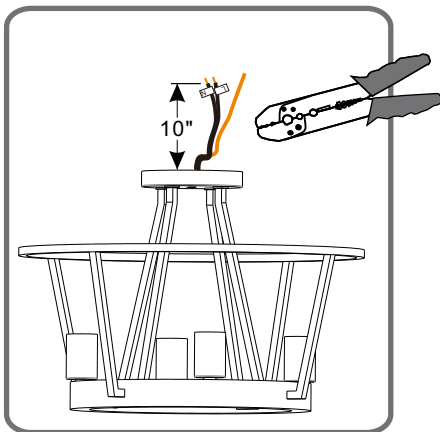

2

White wire (neutral)
from outlet box

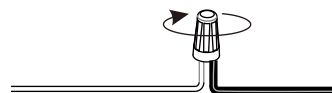

Supply wire from fixture
ribbed side or identified
with the Label "N"

Black or Red wire (hot)
from outlet box

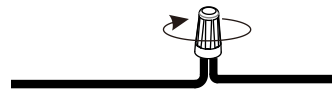

supply wire from fixture
smooth side or identified
with the label "L"

Bare or Green ground wire
from outlet box

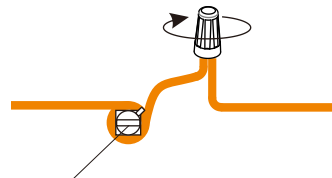

Ground wire
from Fixture

*Green Ground Screw
on crossbar optional

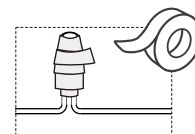

STEP 3B

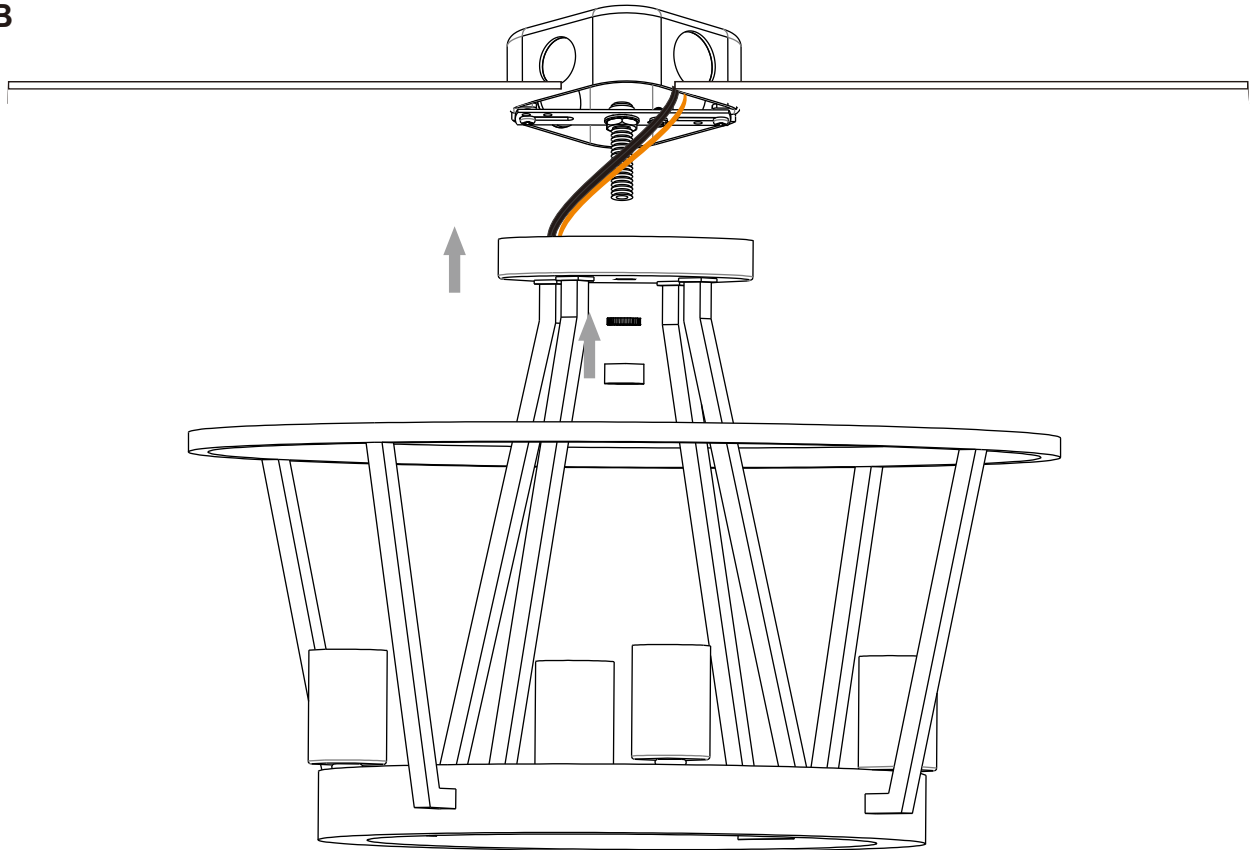

STEP 4B

