

Tools Required

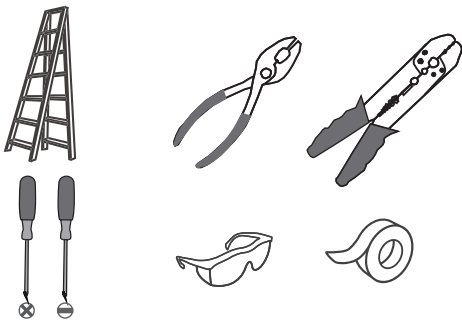

Light Source

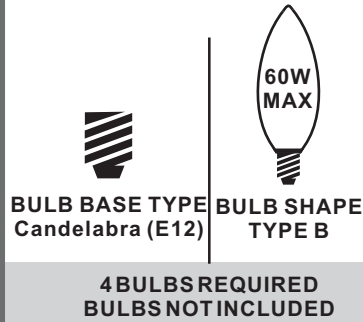

Fixture Height Adjustable 27.25" to 63.25"

⚠ Warnings and Cautions

Turn off the electricity at the circuit breaker before installation. Consult a licensed electrician if in doubt about installation.

Turn off power to the fixture and allow the bulbs to cool before replacing.

Package Contents

Preparation: Identify and inspect all parts before beginning the installation.

Missing or damaged parts? Contact your original place of purchase.

PARTS BAG

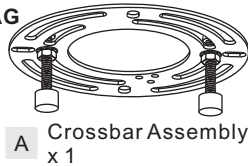

A Crossbar Assembly x 1



B Outlet Box Screw x 2



C Wire Connector x 3

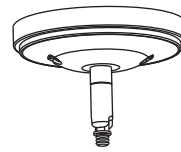

D Ceiling Canopy x 1



E 6" L Rod x 2

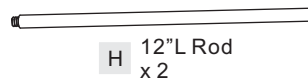

H 12" L Rod x 2

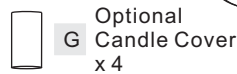

G Optional Candle Cover x 4

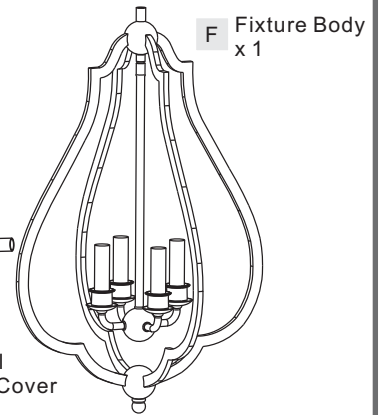

F Fixture Body x 1

Table of Contents

Crossbar Assembly

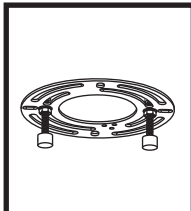

STEP 1

Downrod

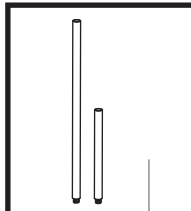

STEP 2

Wiring

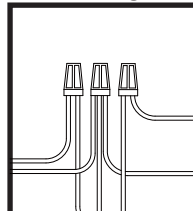

STEP 3

Ceiling Canopy

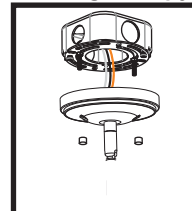

STEP 4

Bulb

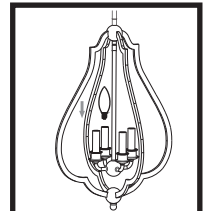

STEP 5

STEP 1

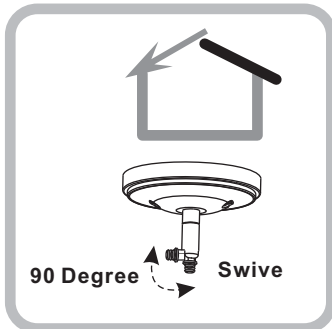

90 Degree Swive

For angled ceilings, Swivel opening towards wall.

1

Step 1
Install crossbar assembly

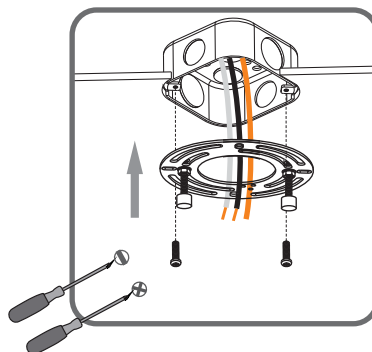

2

Step 2 - 3
Test fitting ceiling canopy to mounting screws

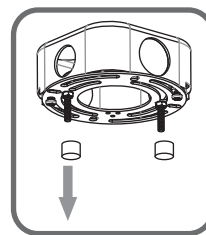

3

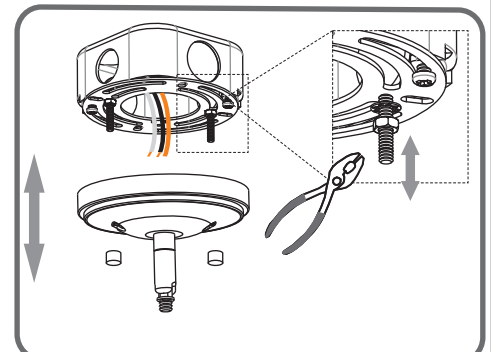

STEP 2

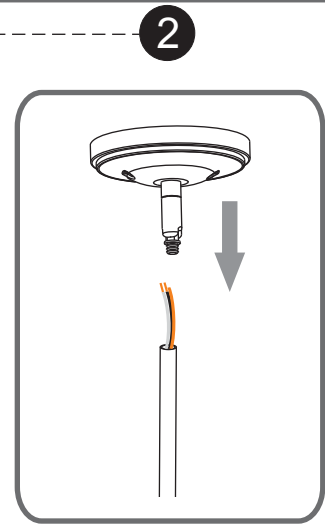
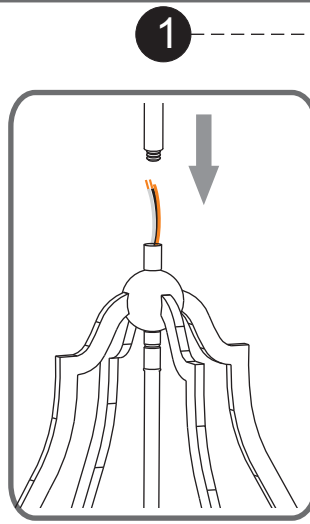
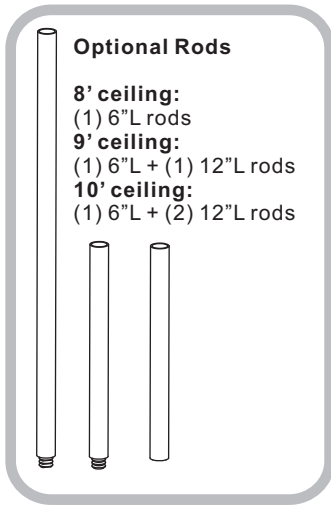

STEP 3

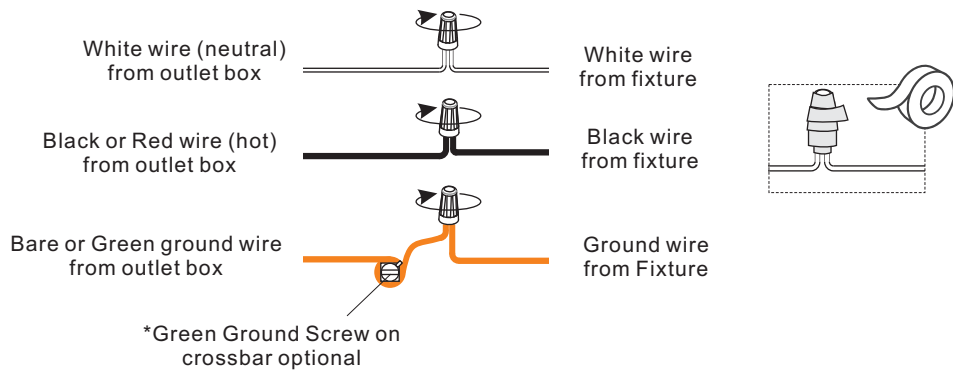

STEP 4

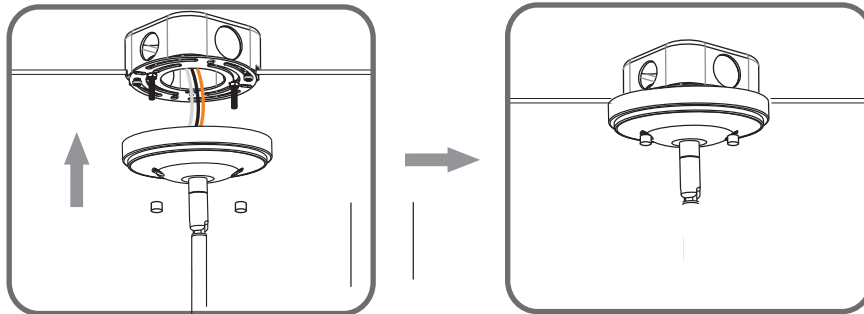

STEP 5

