

Tools Required

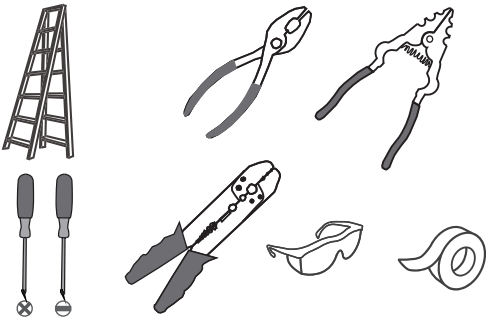

Light Source

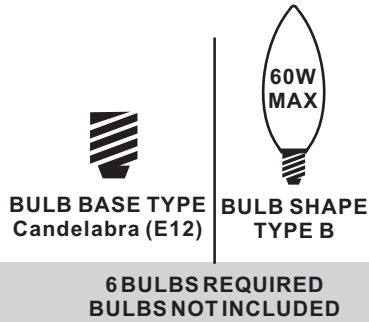

Fixture Height Adjustable 31.5" to 79.5"

Warnings and Cautions

Turn off the electricity at the circuit breaker before installation. Consult a licensed electrician if in doubt about installation.

Turn off power to the fixture and allow the bulbs to cool before replacing.

Package Contents

Preparation: Identify and inspect all parts before beginning the installation.

Missing or damaged parts? Contact your original place of purchase.

PARTS BAG

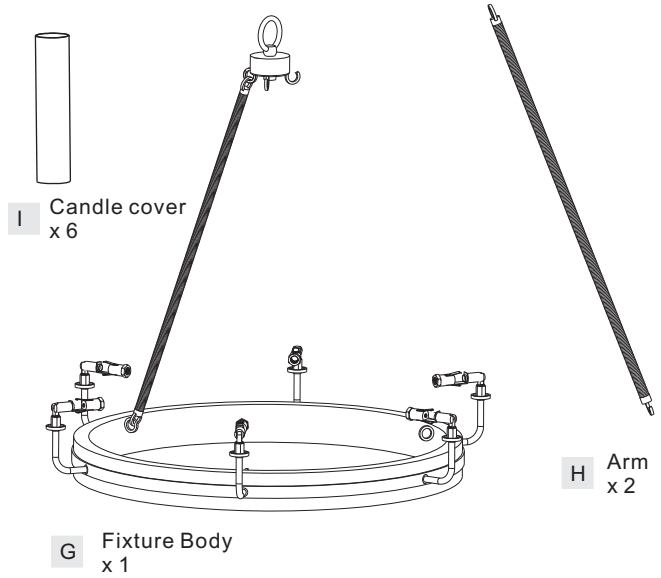
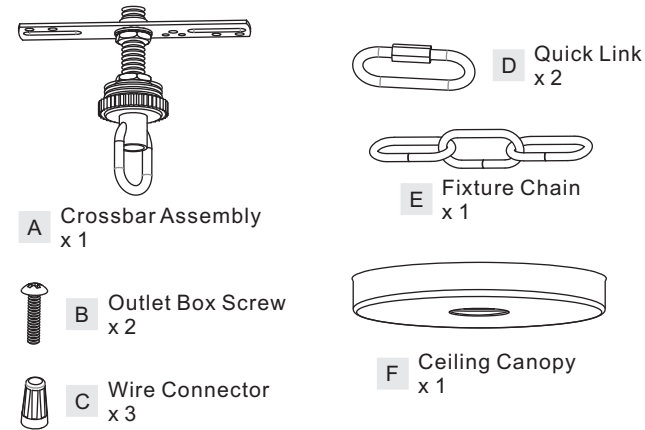
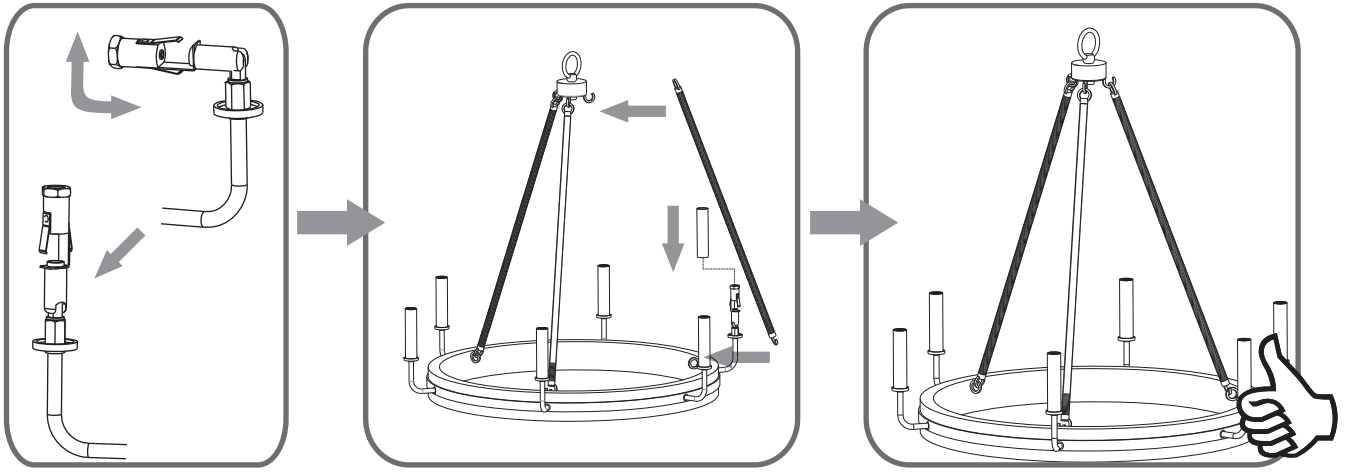

Table of Contents

Fixture Body	Crossbar Assembly	Fixture Chain	Wiring	Ceiling Canopy	Bulb
STEP 1	STEP 2	STEP 3	STEP 4	STEP 5	STEP 6

STEP 1



STEP 2

1

Step 1
Install crossbar assembly

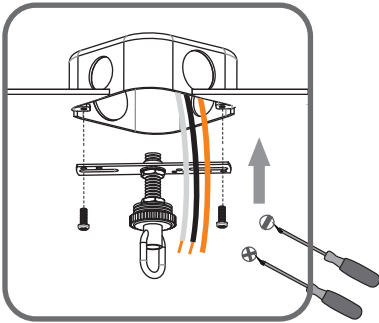

2

Step 2 - 3
Test fitting ceiling canopy to nipple

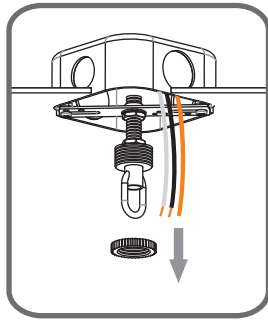

3

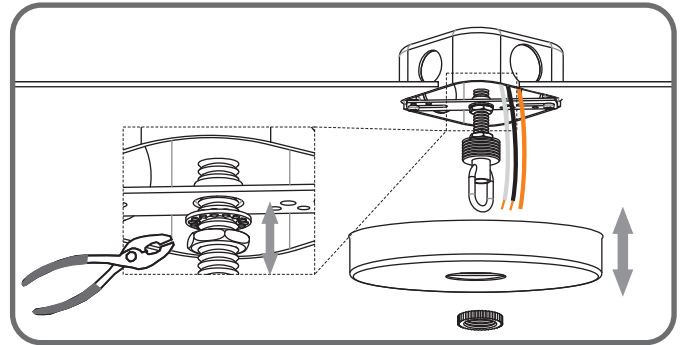

STEP 3

1

Step 1
Adjust fixture chain length

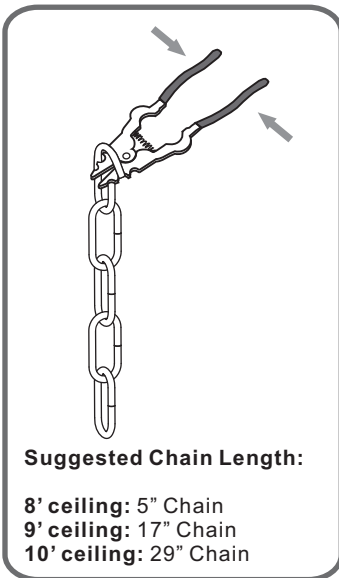

2

Step 2 - 3
Install Fixture Chain

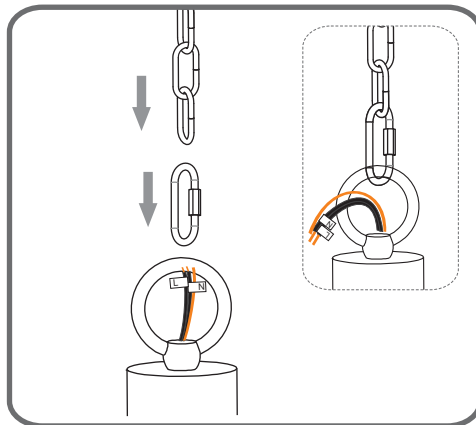

3

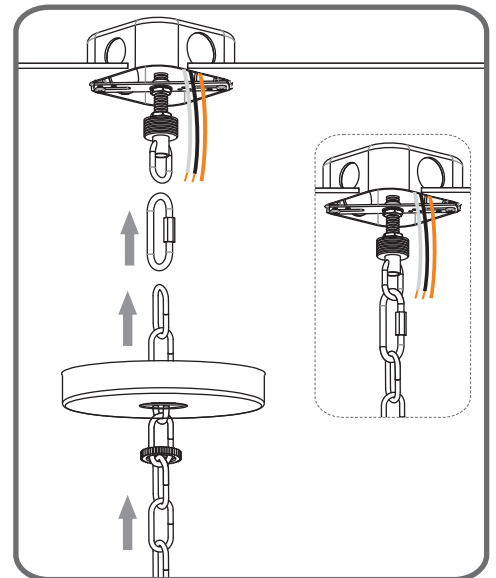

STEP 4

1

Step 1
Feed the fixture wires
through the loop

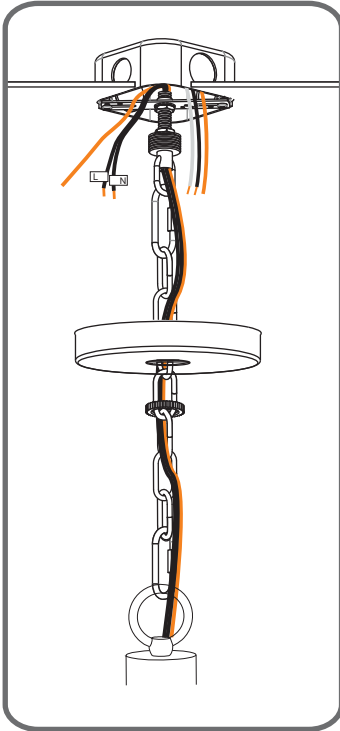

2

White wire (neutral)
from outlet box

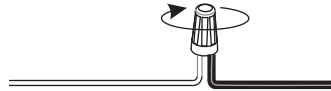

Supply wire from fixture
ribbed side or identified
with the Label "N"

Black or Red wire (hot)
from outlet box

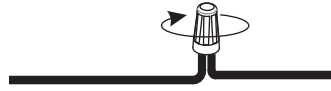

supply wire from fixture
smooth side or identified
with the label "L"

Bare or Green ground wire
from outlet box

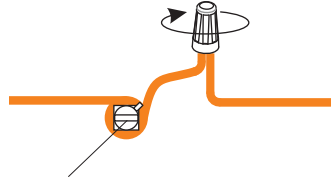

Ground wire
from Fixture

*Green Ground Screw
on crossbar optional

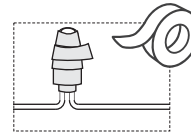

STEP 5

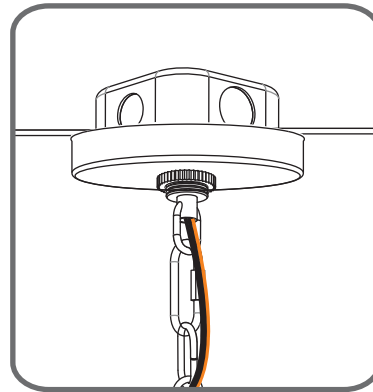
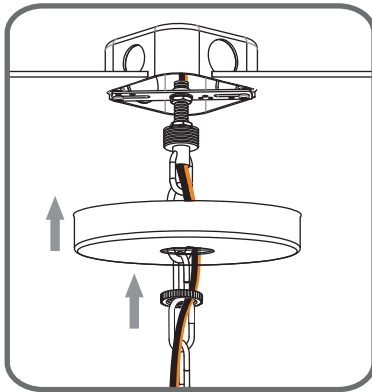

STEP 6

