

Tools Required

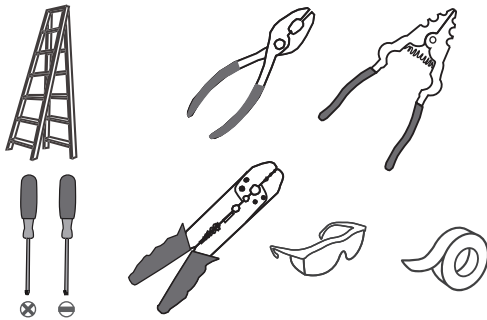

Light Source

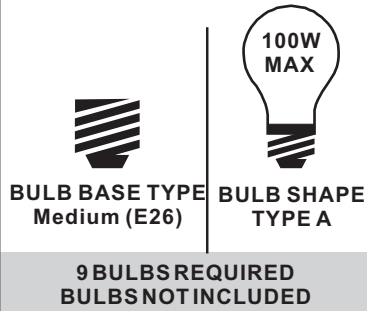

**Fixture Height Adjustable
34.25" to 130.25"**

Warnings and Cautions

Turn off the electricity at the circuit breaker before installation. Consult a licensed electrician if in doubt about installation.

Turn off power to the fixture and allow the bulbs to cool before replacing.

Package Contents

Preparation: Identify and inspect all parts before beginning the installation.

Missing or damaged parts? Contact your original place of purchase.

PARTS BAG

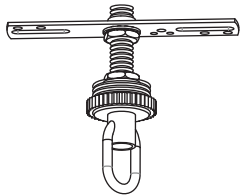

A Crossbar Assembly x 1



B Outlet Box Screw x 2



C Wire Connector x 3



D Quick Link x 2

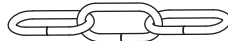

E Fixture Chain x 1



F Ceiling Canopy x 1



G Fixture Loop x 1

Note: Shade shape is for illustration purpose only. Your shade shape may vary from illustration.

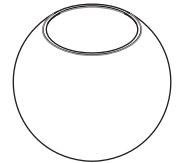

H Shade (Varies according to style purchased) x 9

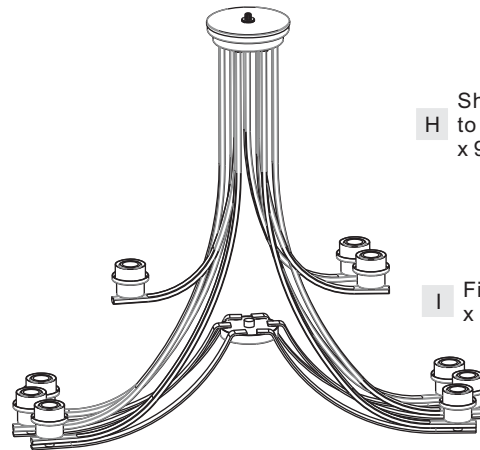

I Fixture Body x 1

Table of Contents

Fixture Loop	Crossbar Assembly	Fixture Chain	Wiring	Ceiling Canopy	Shade & Bulb
STEP 1	STEP 2	STEP 3	STEP 4	STEP 5	STEP 6

STEP 1

1

Step 1
Unfold Support Arms

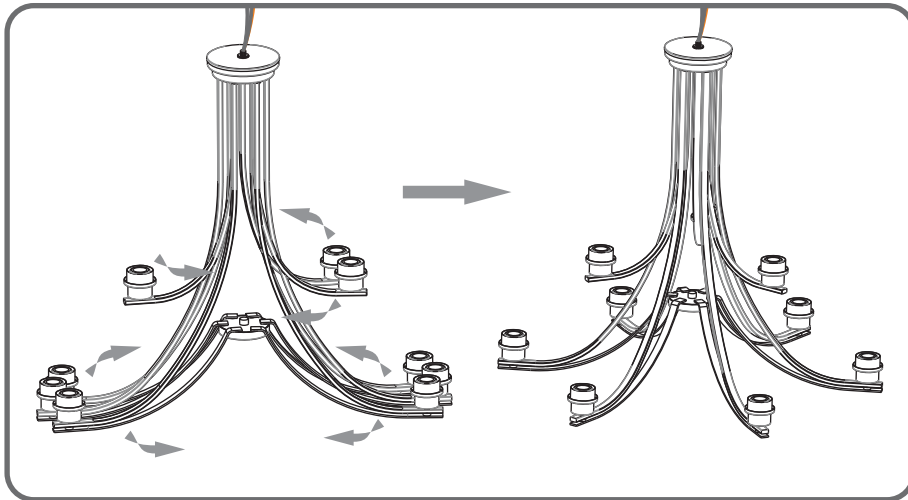

2

Step 2
Install Fixture Loop

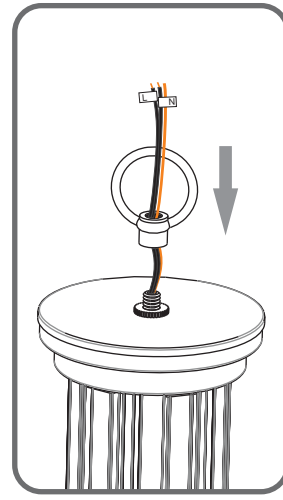

STEP 2

1

Step 1
Install crossbar assembly

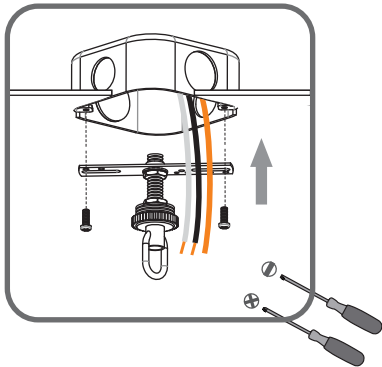

2

Step 2 - 3
Test fitting ceiling canopy to nipple

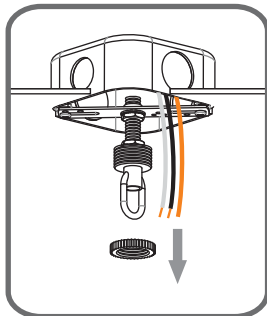

3

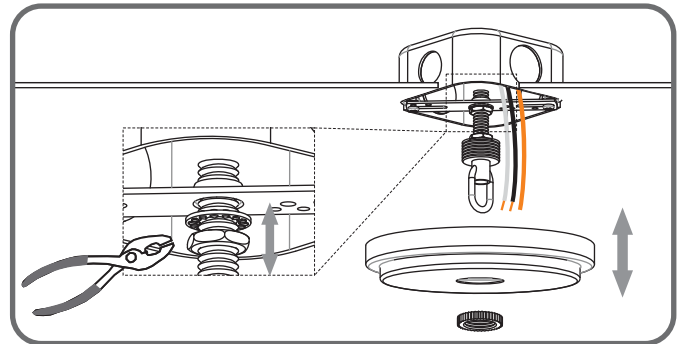

STEP 3

1

Step 1
Adjust fixture chain length

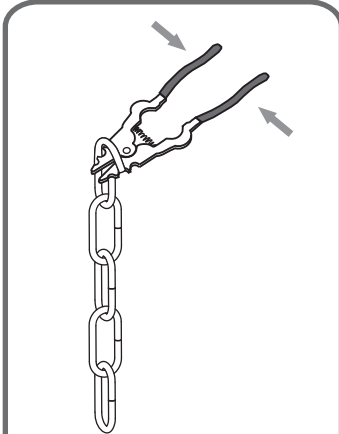

Suggested Chain Length:

- 8' ceiling: 10" Chain
- 9' ceiling: 22" Chain
- 10' ceiling: 32" Chain

2

Step 2 - 3
Install Fixture Chain

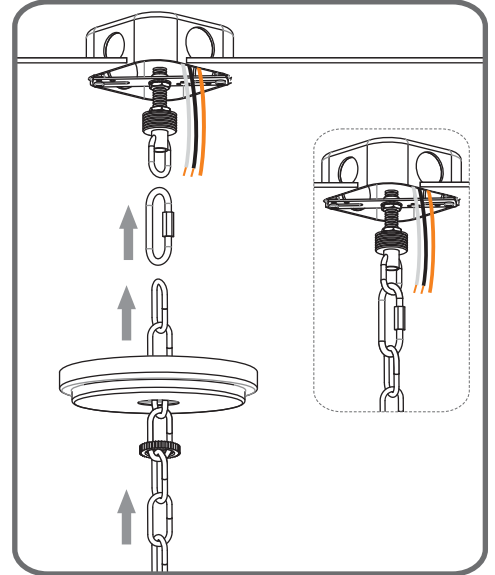
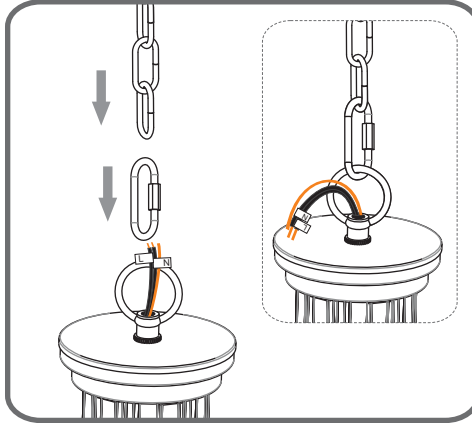

STEP 4

1

Step 1
Feed the fixture wires
through the loop

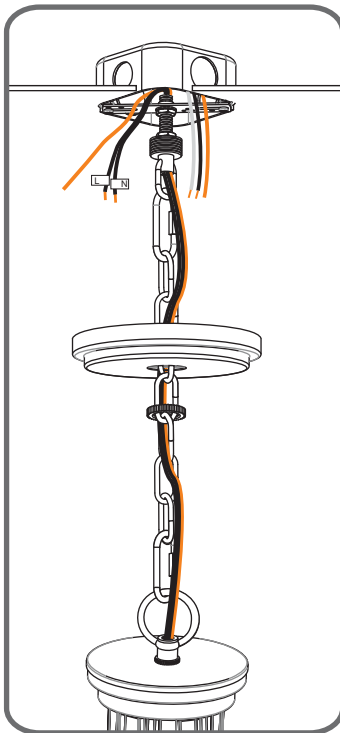

2

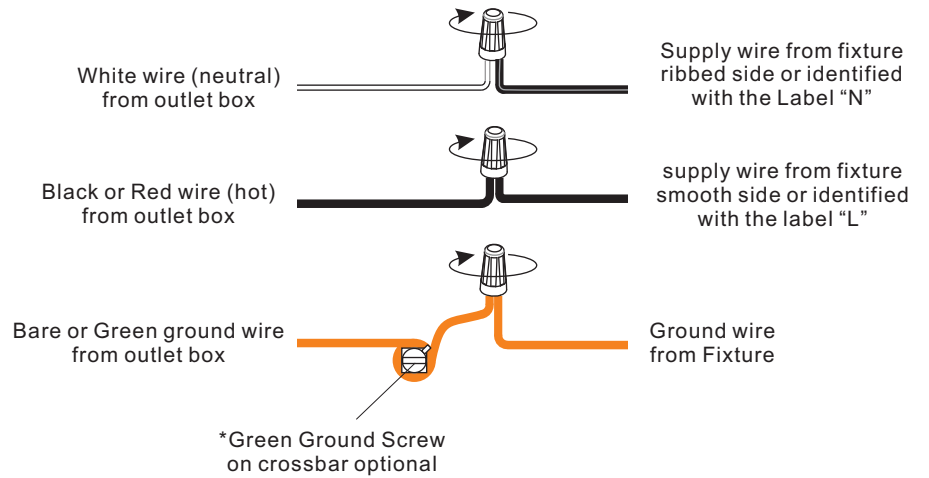

STEP 5

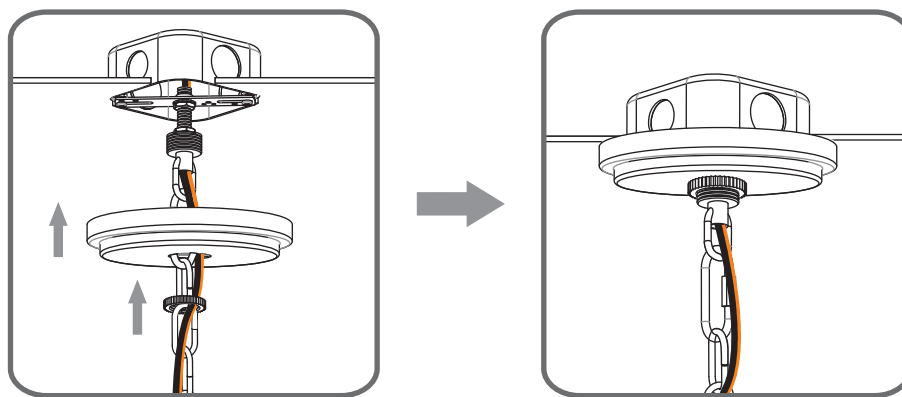

STEP 6

1

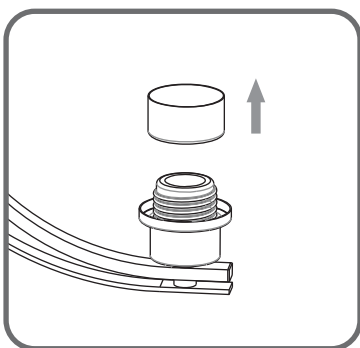

2

Note: Shade shape is for illustration purpose only. Your shade shape may vary from illustration.

