

Please go to www.quoizel.com for product cleaning tips. Go to the **Care + Maintenance** selection.

Tools Required: Flathead screwdriver, Phillips screwdriver, pliers, wire cutters, wire strippers, electrical tape, safety glasses.

Light Source: (2) B10 Candelabra Base bulbs 60W Maximum, bulb not included.

Estimated Assembly Time: 30-45 minutes

Preparation: Identify and inspect all parts before beginning installation. Check package content list and diagrams below to ensure all parts are present. If any parts are missing or damaged, do not attempt to assemble, install, or operate the fixture. Missing Parts? Contact your original place of purchase.

⚠ Warnings and Cautions

Turn off electricity at circuit breaker or main fuse box before installation. Consult a licensed electrician if in doubt.

These instructions are provided for your safety. It is very important you read them completely before installing the fixture. We strongly recommend that a licensed, professional electrician perform the installation.

Disconnect fixture from power source before replacing bulbs. Make sure bulbs are given sufficient time to cool before removal.

Package Contents

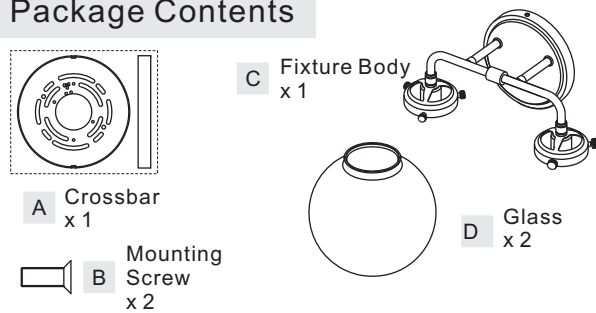

STEP 3 - Install the Glass and the Bulb

- Insert the bulb onto the socket and screw snugly into place.
- Place the Glass (D) into the hood on the fixture body (C) and secure with lock screws. Hand-tighten until snug.

Your fixture is now assembled and ready to use. Enjoy!

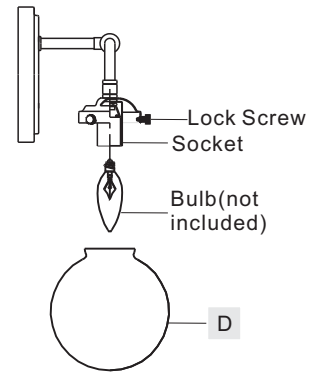

Figure 3

STEP 1 - Install Crossbar and Fixture Body

- Pass the supply wires through the Crossbar (A). Attach the Crossbar (A) to Outlet Box with the head of Green Ground Screw facing you. Secure it with Outlet Box Screws (not included). Tighten until snug.
- Refer to Step 2 for wiring connections.
- Attach the Fixture Body (C) over the Crossbar (A) and secure with Mounting Screws (B). Tighten until snug with screwdrivers.

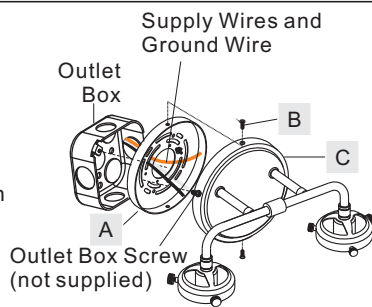
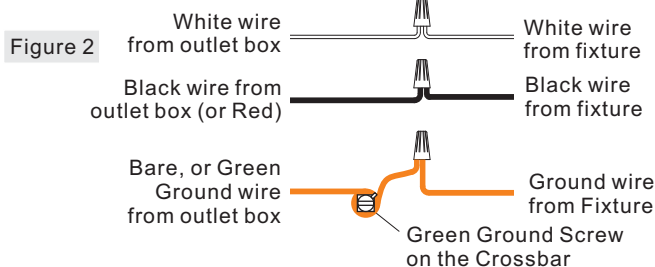

Figure 1

STEP 2 - Wire Connections

- Wrap bare or green ground wire around green ground screw on the crossbar, no less than 2 inches from the end of the wire. Tighten the green ground screw.
- Use standard wire connectors (not included) to make all wire connections. Twist connectors until wires are tightly joined together. Wrap each connection with approved electrical tape and carefully stuff all the connected wires into the Outlet Box.



LRY8615C

FINISH: Polished Chrome

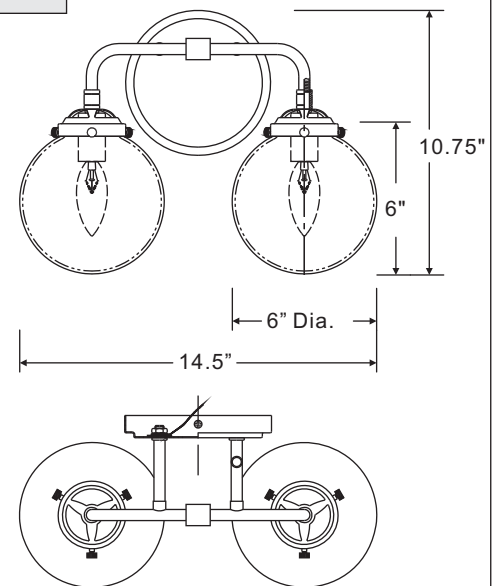

NOTE: ALL DIMENSIONS ARE ROUNDED UP TO THE NEAREST 1/4"