

Please go to [www. quozel. com](http://www. quozel. com) for product cleaning tips. Go to the **Care + Maintenance** selection.

**Tools Required:** Flathead screwdriver, Phillips screwdriver, pliers, wire cutters, wire strippers, electrical tape, safety glasses.

**Light Source:** Integrated 26W LED

**Compatible Dimmer Switches:** Lutron DVELV-300P or Lutron SELV-300P.

**Estimated Assembly Time:** 20-30 minutes

**Preparation:** Identify and inspect all parts before beginning installation. Check package content list and diagrams below to be sure all parts are present. If any parts are missing or damaged, do not attempt to assemble, install, or operate the fixture. Contact customer service for replacement parts.

### ⚠ Warnings and Cautions

Turn off electricity at circuit breaker or main fuse box before installation. Consult a licensed electrician if in doubt.

These instructions are provided for your safety. It is very important you read them completely before installing the fixture. We strongly recommend that a licensed, professional electrician perform the installation.

### Package Contents



**A** Inner Backplate  
x 1



**B** Mounting Screw  
x 2

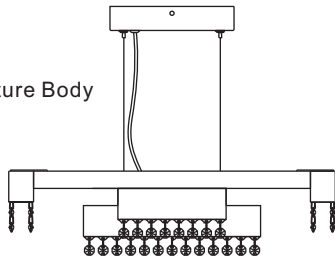

**C** Fixture Body  
x 1

**D** Crystal A  
x 16  **9**

**E** Crystal B  
x 16  **11**

**F** Crystal C  
x 24  **7**

**G** Crystal D  
x 28  **6**

**H** Crystal E  
x 8  **15**

**I** Crystal F  
x 8  **12**

**J** Crystal G  
x 8  **8**

**K** Crystal H  
x 8  **13**

**L** Allen Wrench  
x 1 

### STEP 1 – Adjust Fixture Height

- Unlock Set Screw on the Rope Clamp by using the Allen Wrench (L).
- With screwdrivers, remove the Screw to open the Wire Clasp in the ceiling canopy.
- Push the Pin on the bottom center of the Ceiling Canopy, adjust the Steel Cable in or out of the Ceiling Canopy to achieve your desired hanging height. Once your desired hanging height is achieved, move the Rope Clamp close to hex nut inside of the Ceiling Canopy, and then tighten the Set Screw with the Allen Wrench (L).
- Insert slack wires into Ceiling Canopy. Attach Wire to Wire Clasp in the Ceiling Canopy and secure with the Screw previously removed. Tighten until snug with screwdrivers.

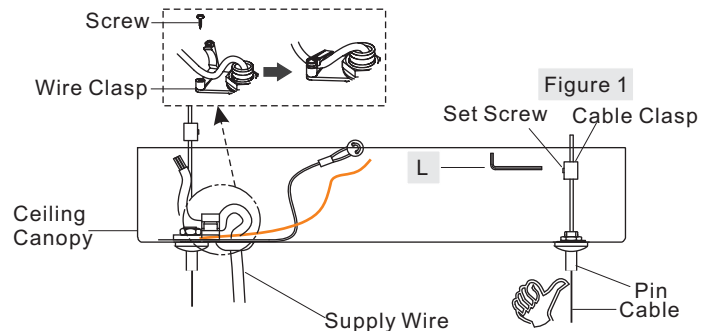

### STEP 2: Install Inner Backplate

- Secure the crossbar (A) to the outlet box (not included) with outlet box screws. Tighten until snug.

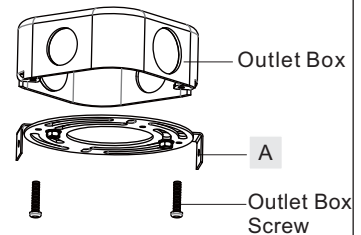

### STEP 3 - Attach Lanyard

- The purpose of the lanyard is to provide the installer a means to support the fixture from the junction box while connecting the electrical wires. This enables the fixture to hang from the junction box and your hands are free to make the wire connections.
- Turn the Button Stop so it may be inserted into the Inner Backplate slot. Make sure the Button Stop is completely inside the Inner Backplate (A). Slowly release the fixture to make sure it is supported by the Button Stop. Proceed to the wiring steps in the next step. Once you are complete with the wiring there is nothing to do with Lanyard. The Lanyard will push into the junction box when the fixture is placed for final mounting.

**Thank you for purchasing a Quoizel product.**  
**Need assistance with parts or assembly? Call Quoizel customer service at 1-800-645-3184**  
**or visit us on-line at [www. quozel. com](http://www. quozel. com)**

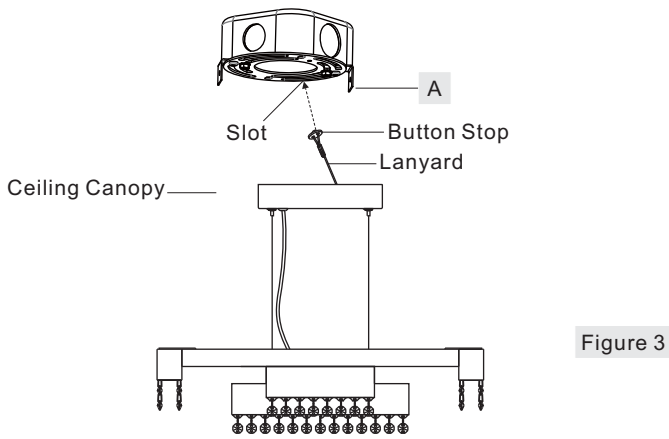

Figure 3

**STEP 4 - Make Wire Connections**

- A. Wrap bare or green ground wire around green ground screw on the inner backplate, no less than 2 inches from the end of the wire. Tighten the green ground screw.
- B. Use standard wire connectors (not included) to make all wire connections. Twist connectors until wires are tightly joined together. Wrap each connection with approved electrical tape and carefully stuff all the connected wires into the Outlet Box.
- C. If the electrical wire from fixture is going to be cut shorter than provided, strip back the clear wire covering the 3 fixture wires as far as you need to. This will expose each fixture wire individually. Strip each end of 3 fixture wires.

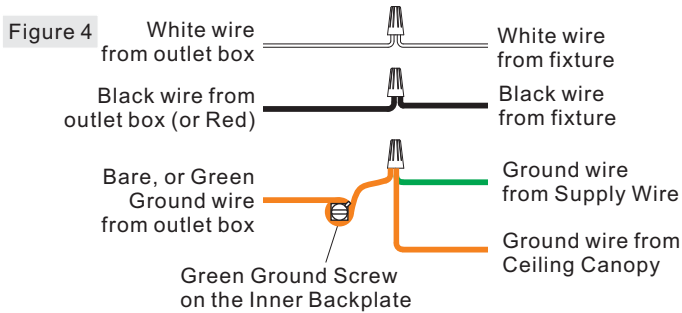

Figure 4

**STEP 5 - Install Fixture Body**

- A. Attach the ceiling canopy and the Fixture Body (C) over the Inner Backplate (A) and secure with Mounting Screws (B). Tighten until snug with screwdrivers.

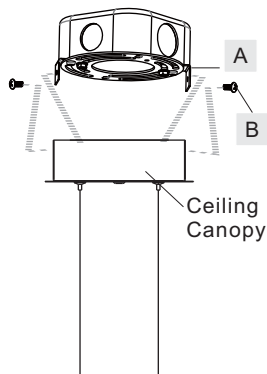

Figure 5

**STEP 6 - Install Crystal**

- A. Refer to Accent Distribution to identify the suggested hanging locations of Crystal A-H (D-K).

Your fixture is now assembled and ready to use. Enjoy!

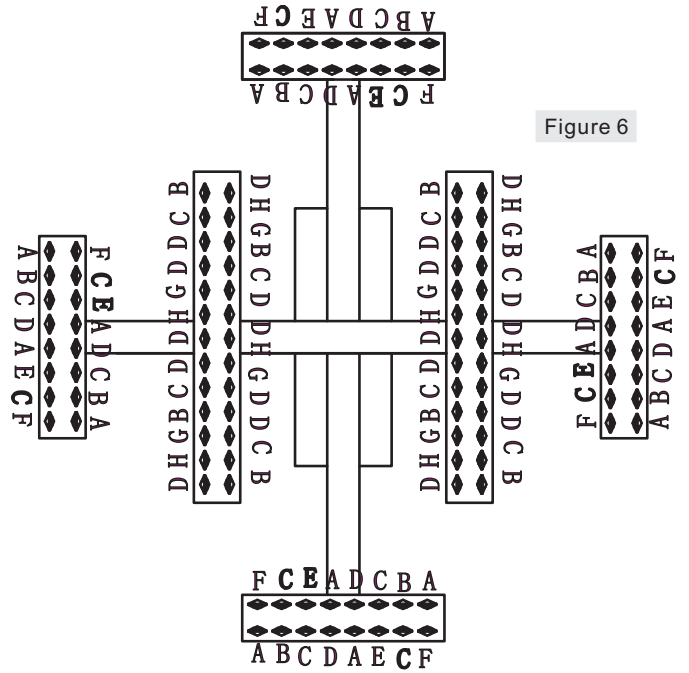
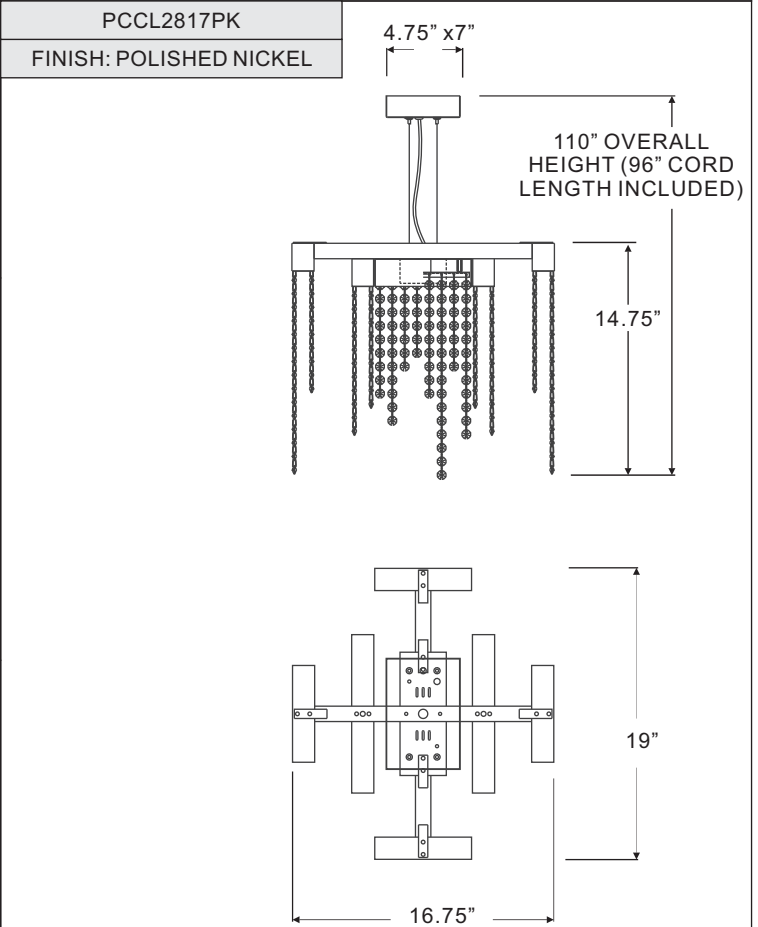

Figure 6

**ACCENT DISTRIBUTION**



NOTE: ALL DIMENSIONS ARE ROUNDED UP TO THE NEAREST 1/4"

Thank you for purchasing a Quoizel product.  
 Need assistance with parts or assembly? Call Quoizel customer service at 1-800-645-3184  
 or visit us on-line at [www.quoizel.com](http://www.quoizel.com)