

Please go to www. quozel. com for product cleaning tips. Go to the **Care + Maintenance** selection.

Tools Required: Flathead screwdriver, Phillips screwdriver, pliers, wire cutters, wire strippers, electrical tape, safety glasses.

Light Source: (1) A19 Medium Base bulb 100W Maximum or
(1) Medium Base Vintage bulb is recommended but not supplied.

Estimated Assembly Time: 30-45 minutes

Preparation: Identify and inspect all parts before beginning installation. Check package content list and diagrams below to be sure all parts are present. If any parts are missing or damaged, do not attempt to assemble, install, or operate the fixture. Contact customer service for replacement parts.

⚠ Warnings and Cautions

Turn off electricity at circuit breaker or main fuse box before installation. Consult a licensed electrician if in doubt.

These instructions are provided for your safety. It is very important you read them completely before installing the fixture. We strongly recommend that a licensed, professional electrician perform the installation.

Disconnect fixture from power source before replacing bulbs. Make sure bulbs are given sufficient time to cool before removal.

Package Contents

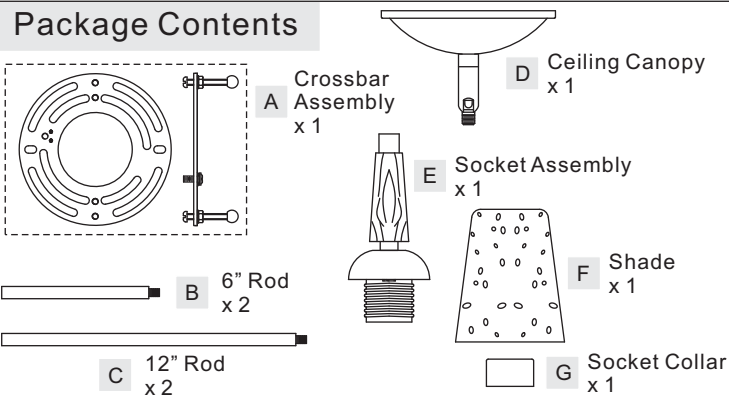

STEP 1 - Install Ceiling Canopy, Rods and Socket Assembly together

- Determine the Rods (B/C) to be assembled to the Socket Assembly (E) according to your hanging height.
- Pass the supply wires and ground wire through the chosen rods (B/C) and the Ceiling Canopy (D). Thread the Socket Assembly (E), the chosen Rods (B/C) and the Ceiling Canopy (D) together. Hand tighten until snug.

Suggested rods for Ceiling height:
8' ceiling : use (2) 12" rods
9' ceiling : use (2) 6" rods and (2) 12" rods

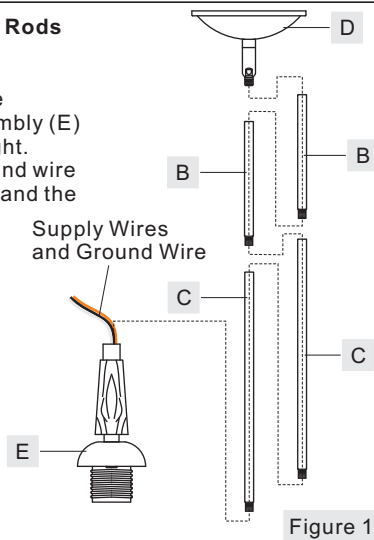

Figure 1

STEP 2 - Installing the Crossbar Assembly

- Pass the supply wires through the Crossbar Assembly (A). Attach the Crossbar Assembly (A) to the Outlet Box with the head of the Green Ground Screw facing you. Secure the Crossbar Assembly (A) with Outlet Box Screws (not included). Tighten until snug.

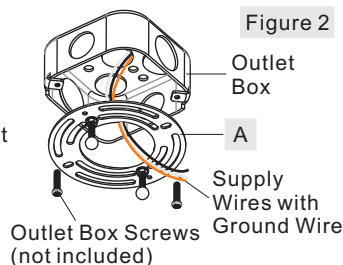

Figure 2

STEP 3 - Test Fit the Ceiling Canopy to the Crossbar Assembly

- Remove the mounting balls from the Crossbar Assembly (A). Place the Ceiling Canopy (D) onto the Crossbar Assembly (A) and secure with mounting balls. Note: The Ceiling Canopy (D) should be snug against the ceiling and held tight with the mounting balls. If it is not, adjust the length of the mounting screws on the Crossbar Assembly (A) by unscrewing the preassembled hex nut and lock washer and then screwing the mounting screws in or out of the crossbar until the correct length is achieved. Once the Ceiling Canopy (D) is secure, remove the mounting ball and Ceiling Canopy (D) and proceed to Step 4.

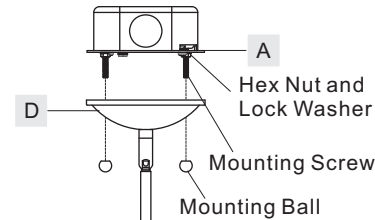

Figure 3

STEP 4 - Wire Connections

- Use standard wire connectors (not included) to make all wire connections. Twist connectors until wires are tightly joined together. Wrap each connection with approved electrical tape and carefully stuff all the connected wires into the Outlet Box.

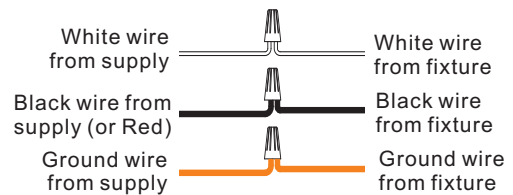

Figure 4

STEP 5 - Install the Fixture

- Position the Ceiling Canopy (D) onto the Crossbar Assembly (A). Place the holes in the ceiling canopy over the mounting screws. Secure the Fixture by using the mounting balls and hand tighten the mounting balls until snug.

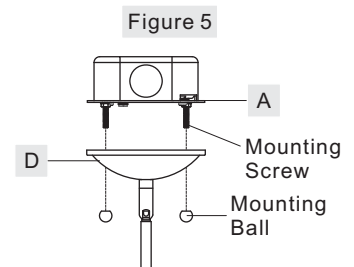

Figure 5

Thank you for purchasing a Quozel product.
Need assistance with parts or assembly? Call Quozel customer service at 1-800-645-3184
or visit us on-line at www. quozel. com

STEP 6 – Install Shade and Bulb

- A. Place Shade (F) over socket and secure with Socket Collar (G). Hand tighten until snug.
- B. Insert bulb onto socket and screw snugly into place.

Your fixture is now assembled and ready to use. Enjoy!

Figure 6

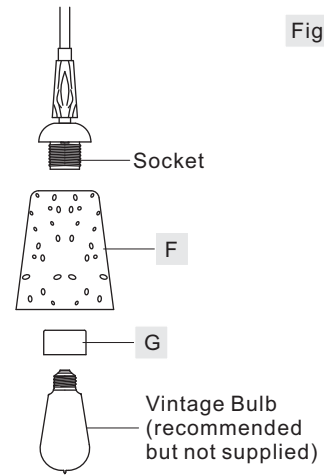

HE1505BN
FINISH: BRUSHED NICKEL

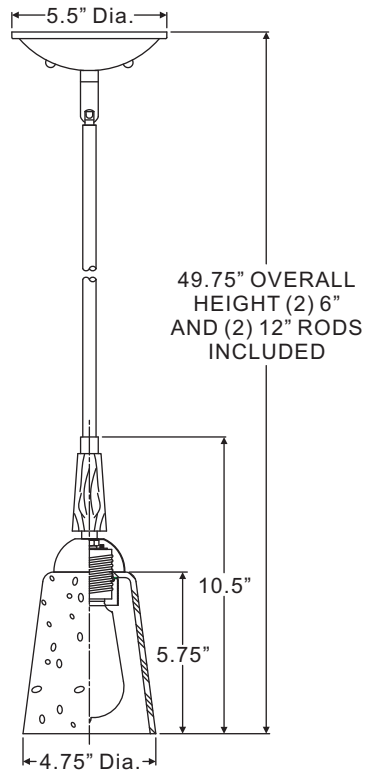
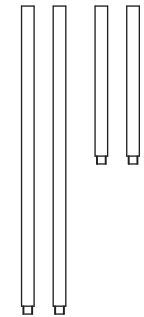
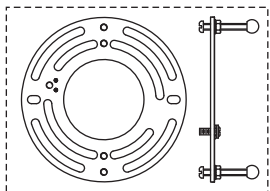

NOTE: ALL DIMENSIONS ARE ROUNDED UP TO THE NEAREST 1/4"

Thank you for purchasing a Quoizel product.
Need assistance with parts or assembly? Call Quoizel customer service at 1-800-645-3184
or visit us on-line at www.quoizel.com