

Please go to [www. quozel. com](http://www. quozel. com) for product cleaning tips. Go to the **Care + Maintenance** selection.

**Tools Required:** Flathead screwdriver, Phillips screwdriver, pliers, wire cutters, wire strippers, electrical tape, safety glasses.

**Light Source:** Integrated 8W LED

**Compatible Dimmer Switches:** Lutron AYCL-153P or Lutron DVCL-153P.

**Estimated Assembly Time:** 20-30 minutes

**Preparation:** Identify and inspect all parts before beginning installation. Check package content list and diagrams below to be sure all parts are present. If any parts are missing or damaged, do not attempt to assemble, install, or operate the fixture. Contact customer service for replacement parts.

## ⚠ Warnings and Cautions

Turn off electricity at circuit breaker or main fuse box before installation. Consult a licensed electrician if in doubt.

These instructions are provided for your safety. It is very important you read them completely before installing the fixture. We strongly recommend that a licensed, professional electrician perform the installation.

## Package Contents

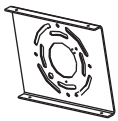

**A** Inner Backplate x 1



**B** Mounting Screw x 4

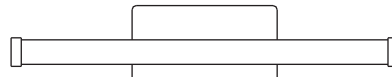

**C** Fixture Body x 1

### STEP 1 - Install Inner Backplate and Fixture Body

A. Pass the supply wires and ground wire through the Inner Backplate (A). Attach the Inner Backplate (A) to Outlet Box with the head of Green Ground Screw facing you. Secure it with Outlet Box Screws (not included). Tighten until snug.

B. Refer to Step 2 for wiring connections.

C. Attach the backplate of the Fixture Body (C) over the Inner

Backplate (A) and secure with Mounting Screws (B). Tighten until snug with screwdrivers.

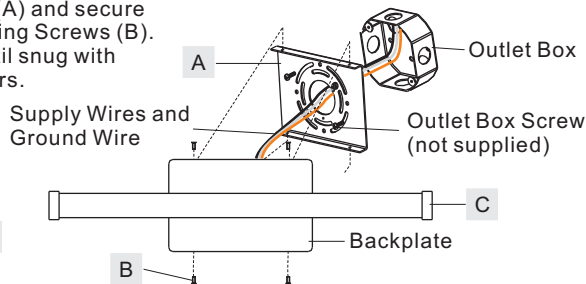

### Replace the Shade:

A. Remove the Lock and Bracket from the Fixture Body.

B. Remove the shade and add the replacement into the same position, line up the hole on the Bracket and the mounting hole on the Shade Holder, secure by threading Lock Screw into the mounting hole, tighten until snug.

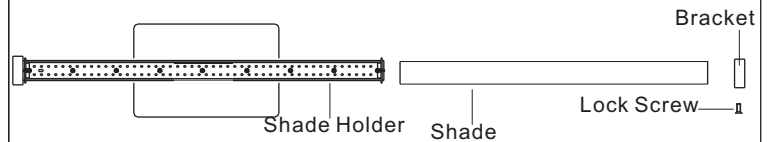

### STEP 2 - Wire Connections

A. Use standard wire connectors (not included) to make all wire connections. Twist connectors until wires are tightly joined together. Wrap each connection with approved electrical tape and carefully stuff all the connected wires into the Outlet Box.

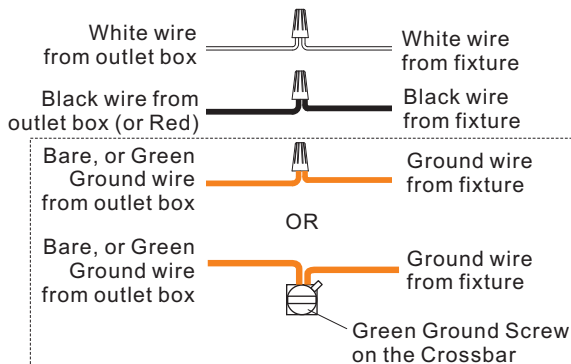

Your fixture is now assembled and ready to use. Enjoy!

PCPE8519BN

FINISH: BRUSHED NICKEL

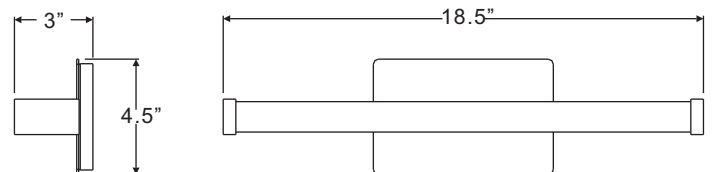
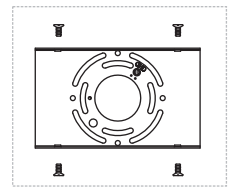

NOTE: ALL DIMENSIONS ARE ROUNDED UP TO THE NEAREST 1/4"

**Thank you for purchasing a Quoizel product.**  
**Need assistance with parts or assembly? Call Quoizel customer service at 1-800-645-3184**  
**or visit us on-line at [www. quozel. com](http://www. quozel. com)**