

Please go to www. quozel. com for product cleaning tips. Go to the **Care + Maintenance** selection.

Tools Required: Flathead screwdriver, Phillips screwdriver, pliers, wire cutters, wire strippers, electrical tape, safety glasses.

Light Source: (1) A19 Medium Base 60W Maximum, Alternate bulb (1) 13W CFL.

Estimated Assembly Time: 30-45 minutes

Preparation: Identify and inspect all parts before beginning installation. Check package content list and diagrams below to be sure all parts are present. If any parts are missing or damaged, do not attempt to assemble, install, or operate the fixture. Contact customer service for replacement parts.

⚠ Warnings and Cautions

Turn off electricity at circuit breaker or main fuse box before installation. Consult a licensed electrician if in doubt.

These instructions are provided for your safety. It is very important you read them completely before installing the fixture. We strongly recommend that a licensed, professional electrician perform the installation.

Disconnect fixture from power source before replacing bulbs. Make sure bulbs are given sufficient time to cool before removal. Do not subject glass parts to any shock while in operation or shattering may result.

Package Contents

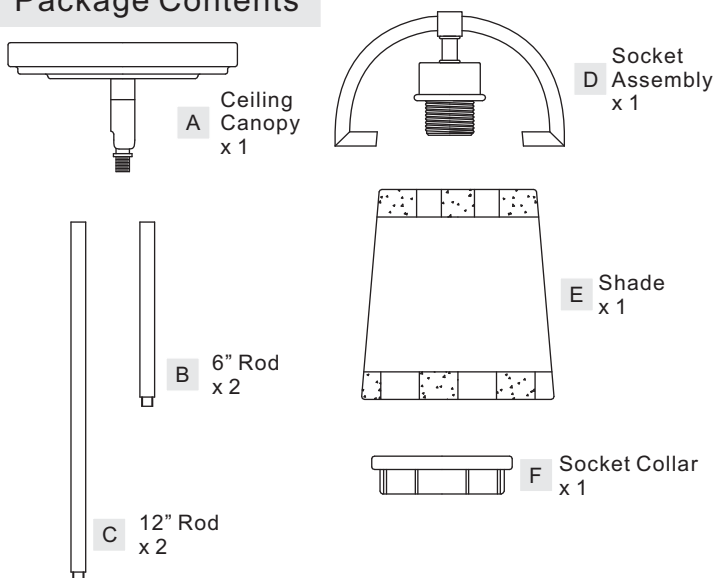

Hardware Contents

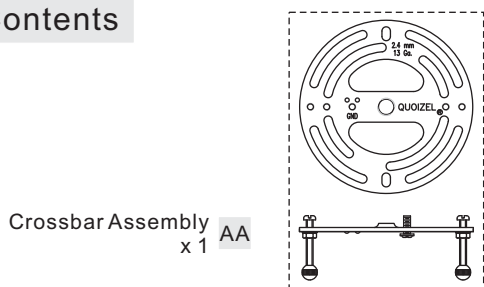

STEP 1 – Assemble the Rods and the Ceiling Canopy

- Determine the Rods (B/C) to be assembled to the Socket Assembly (D) according to your hanging height.
- Pass the supply wires and ground wire through the chosen rods (B/C) and the Ceiling Canopy (A). Thread the Socket Assembly (D), the chosen Rods (B/C) and the Ceiling Canopy (A) together. Hand tighten until snug.

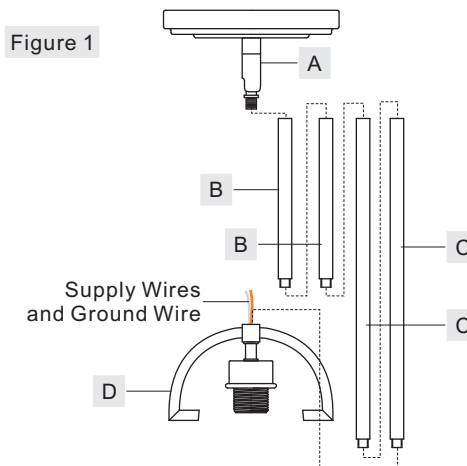

STEP 2 – Install Crossbar Assembly

- Pass the supply wires through the Crossbar Assembly (AA). Attach the Crossbar Assembly (AA) to the Outlet Box with the head of the Green Ground Screw facing you. Secure it with Outlet Box Screws (not included). Tighten until snug.

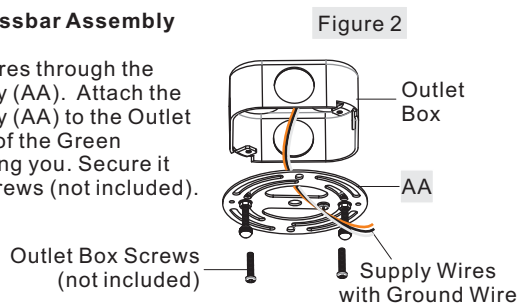

STEP 3 – Fit Ceiling Canopy to Crossbar Assembly

- Remove mounting balls from the Crossbar Assembly (AA). Fit the Ceiling Canopy (A) to the Crossbar Assembly (AA) and secure with mounting balls. Note: The Ceiling Canopy (A) should be snug against the ceiling and the mounting balls. If

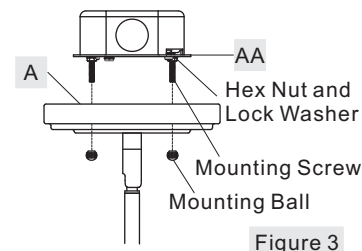

not, adjust the length of the nipple on the Crossbar Assembly (AA) by unscrewing the preassembled hex nut and lock washer and then screwing the mounting screws in or out of the crossbar until the correct length is achieved. Once the Ceiling Canopy (A) is secure, remove the mounting ball and Ceiling Canopy (A) and proceed to Step 4.

Thank you for purchasing a Quozel product.
Need assistance with parts or assembly? Call Quozel customer service at 1-631-273-2700
or visit us on-line at www. quozel. com

STEP 4 - Wire Connections

A. Use standard wire connectors (not included) to make all wire connections. (Connectors are not included with fixture.) Twist connectors until wires are tightly joined together. Wrap each connection with approved electrical tape and carefully stuff all the connected wires into the Outlet Box.

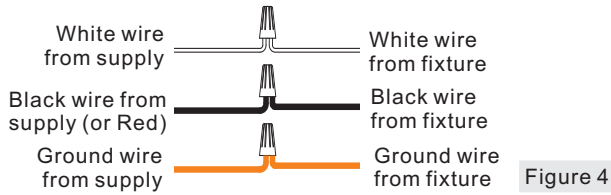

STEP 6 - Install Shade

A. Place the Shade (E) over the Socket and secure with the Socket Collar (F). Hand tighten until snug.

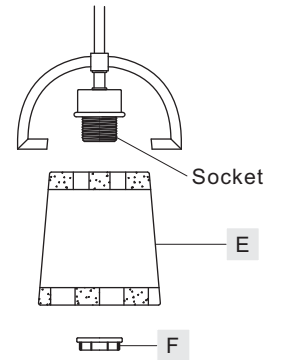

STEP 5 - Install Fixture Body

A. Carefully tuck all wires into the outlet box and position the Ceiling Canopy (A) over the outlet box. Align the holes in the Ceiling Canopy (A) with the mounting screws, then attach the Ceiling Canopy (A) using the previously removed mounting balls. Hand tighten until snug.

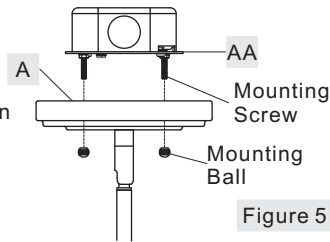

STEP 7 - Install Bulb

A. This fixture uses standard bulb with medium base. Maximum 60 watts.
 B. Insert bulb and screw snugly into place.

Your fixture is now assembled and ready to use. Enjoy!

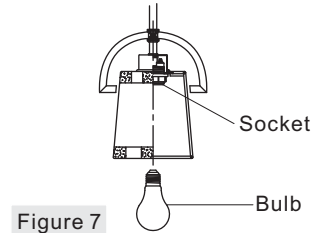

MCKD1505TM

FINISH: TECO MARRONE

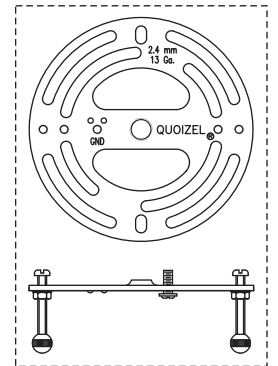
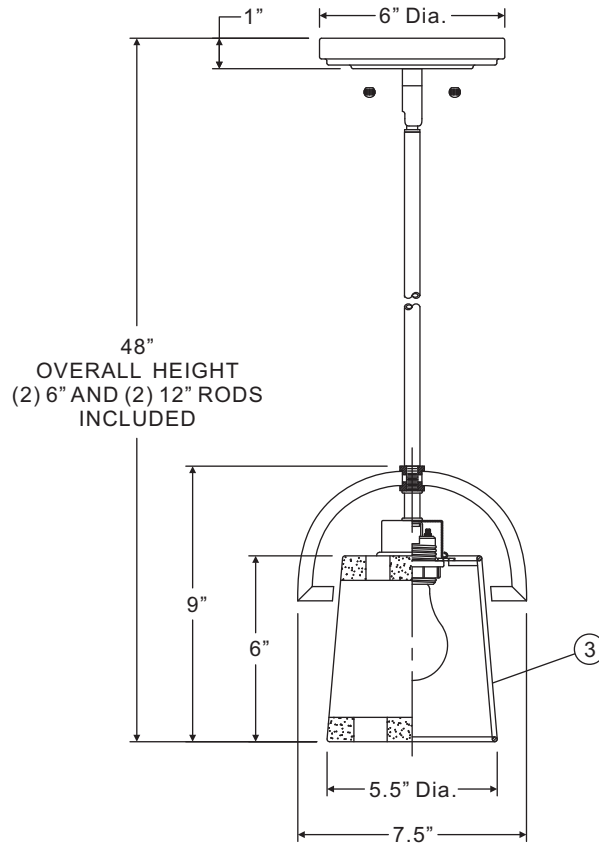
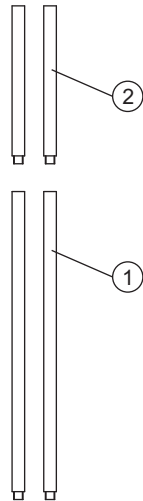

(1) 60W Medium Base Bulbs (Not Supplied)

NOTE: ALL DIMENSIONS ARE ROUNDED UP TO THE NEAREST 1/2"

NO.	PART NUMBER	REPLACEMENT PART DESCRIPTION	REQ.
1	9012EXTM	12"L ROD	2
2	9006EXTM	6"L ROD	2
3	S11955MC	SHADE	1

Thank you for purchasing a Quoizel product.
 Need assistance with parts or assembly? Call Quoizel customer service at 1-631-273-2700 or visit us on-line at www.quoizel.com