



Grilles, Registers, Diffusers, Tools & Installation Supplies

VOLUME IV

RESIDENTIAL & COMMERCIAL



THE PRODUCTS TO GET YOUR JOB DONE!

Get everything you need:

- Grilles, registers & diffusers
- HVAC installation supplies
- Thermostats
- Fasteners and more!

 **FERGUSON**[®]
HVAC

 **PROSELECT**[®]

RESIDENTIAL

Stamped Steel Sidewall/Ceiling Registers

1-Way	7
2-Way	8
2-Way, Metal Lever	9
2-Way, 1/3" Fin	10
3-Way	11
3-Way, Metal Lever	11
3-Way, 1/3" Fin	12
4-Way	12
4-Way, Metal Lever	13



Stamped Steel Curved Blade Registers

1-Way	13
1-Way, Metal Lever	14
2-Way	14
3-Way	15
3-Way, Metal Lever	15
4-Way	16
4-Way, Metal Lever	16



Aluminum Sidewall Registers 17



Aluminum Curved Sidewall/Ceiling Registers

1-Way	18
2-Way	18
3-Way	19
4-Way	19



Vertical Blade Supply Registers 20

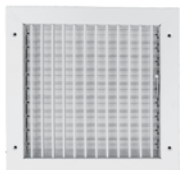

Plastic Sidewall/Ceiling Registers

2-Way	21
3-Way	21
4-Way	22



Return Grilles

Horizontal Blade Return Grilles	23
Stamped Aluminum Return Air Grilles	24
Stamped Steel Return Air Grilles	25
Stamped Steel Return Grilles, 1/3" Fin, 5/16" Turnback	26
Stamped Steel Return Air Filter Grilles	27
Stamped Steel Return Air Filter Grilles, 1/3" Fin	28
Fixed Bar Filter Grilles	29



Floor Registers & Diffusers

Stamped Steel Floor Diffusers	30
Floor Diffusers Deluxe	31
Floor Registers	31
Floor Return Air Grilles	32
Stamped Steel Toe Space Grilles	33



Baseboard Registers, Diffusers & Grilles

Baseboard Registers, 1/3" Fin	33
Return Air Grilles, 1/2" Fin, 7/8" Turnback	34
Stamped Steel Baseboard Return Air Grilles, 1/3" Fin, 7/8" Turnback	34
Baseboard Diffusers	35
Baseboard Return Grilles	35
Baseboard Registers with Damper	35
Baseboard Return Grilles, 1/3" Fin	36



Diffusers, Rings & Registers

Round Ceiling Diffusers	36
Round Ceiling Dampers	36
Duct Rings	37



Aluminum Ceiling Diffusers

3-Way	37
4-Way	38

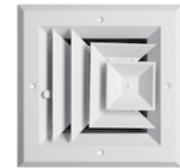

COMMERCIAL

Steel High Velocity T-Bar Diffusers

2-Cone	39
3-Cone	40
3-Cone, Insulated, No Neck	40



Steel Square Plaque T-Bar Diffusers

For T-Bar Lay-in Ceiling Grids	40
For T-Bar Lay-in Ceiling Grids, Insulated	40





Ceiling Diffusers for T-Bar

- Expanded Metal Face 41
- Perforated Supply with Target Back 41
- Perforated Shallow Back 41
- Perforated with Insulated Back 42
- Perforated Supply 42
- Perforated Returns 42
- Return Air Grilles, Perforated 43
- Aluminum Louver Face 43
- Steel Louver Face 44
- Aluminum Square 44
- Aluminum Modular Core with Square Back 45
- Aluminum Modular Core with Square to Round Back 45
- Steel Round Fixed 46



Extruded Aluminum Curved Blades

- Opposed Blade Damper, 1-Way 46
- Opposed Blade Damper, 2-Way 46
- Multi-Shutter Damper, 3-Way 47
- Opposed Blade Damper, 4-Way 47
- Multi-Shutter Damper, 4-Way 47



Diffusers

- Ceiling Diffuser Boxes, 4-Way 48
- Galvanized Steel Double Deflection Spiral Duct Diffusers 48



Sidewall Supplies

- Aluminum Horizontal Registers 49
- Aluminum Vertical/Horizontal 49
- Aluminum Horizontal/Vertical 50

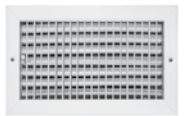

Vertical Blade Supply Registers

- With Opposed Blade Damper 50



Aluminum Fixed Horizontal Blades

- Return 51
- Return for T-Bar 52
- Return Filter Grilles 52
- Return T-Bar Filter Grilles 53



Steel Face Filter Grilles

- For T-Bar Ceilings 53
- For T-Bar Ceilings, Insulated 53
- For T-Bar Ceilings, Perforated 54

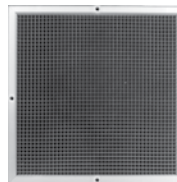

Aluminum Cube Core Returns

- Egg Crate Returns 54
- For T-Bar, Diffuser 55
- For T-Bar, Insulated 55
- Filter Grilles 55



Stamped Steel Face Filter Grilles

- For T-Bar 56
- With Fiberglass Plenum, for T-Bar 56

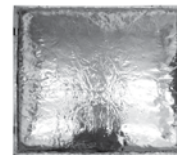

Accessories

- Fiberglass Backpans 56
- T-Bar Plaster Frames 57
- Radial Shutter Dampers 57
- Inlet Collars 57
- Butterfly Dampers 58
- Snap-In Push Pins 58
- Inlet Dampers 58
- Hardware 58



Linear Slot & Pattern Diffusers

- Linear Slot Diffusers 59
- Adjustable Pattern Controllers, Supplies for T-Bar, Non-Insulated/Insulated 59

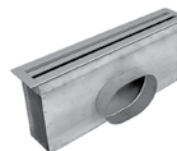

Steel Boot Plenums

- Non-Insulated/Insulated 59

TOOLS & INSTALLATION



Brushes

- Acid Brushes 61
- Chip Brushes 61
- Fitting Brushes 61-62
- Pipe Dope Brushes 62



Condensate Pumps & Accessories

- Pumps 62-63
- Safety Switches 63
- P-Traps 63
- Running Traps 63



Valves
Ball Valves 63-64



Condenser Pads 64



Fasteners
Cable Ties 64
Self Piercing Screws 65
Self Tapping Screws 65
Hanger Straps 65-66
Hose Clamps 66



Gloves
Cut Resistant Gloves 66
Disposable Gloves 67
Driver Gloves 67
Jersey Gloves 67
Knit Gloves 67
Mechanics Gloves 67
PVC Gloves 67
Work Gloves 68



Tapes & Abrasive Cloths
PTFE Pipe Thread Tapes 68
Duct Tapes 68
Electrical Tapes 68
Open Mesh Abrasive Cloths 68-69
Sand Cloths 69



Thermostats
Non-Programmable Thermostats 69
Programmable Thermostats 69



Caulking Supplies
Expanding Foam 70
Acrylic Latex Caulk 70
Siliconized Acrylic Latex Caulk 70
Siliconized Acrylic Caulk 70
100% Silicone Caulk 70
Latex Tub & Tile Caulk 70
RTV High Temperature Silicone Caulk 70
Caulk Guns 70-71



Testing Supplies
Gas Test Gauges 71
Pressure Gauges 71
Mechanical Pressure Gauges 71
Water Test Gauges 71
Thermometers 72



Power Supplies
Extension Cords 72-73
Ground Fault Current Interrupters 73
Power Block Adapters 73
Power Supply Cords 73



Cutting Tools
Jab Saws 73
Hacksaws 73
Snips 73-74
Utility Knives & Blades 74



Hand Tools
Screwdrivers 74-75
Nut Drivers 75
Hex Key Sets 75
Adjustable Wrenches 76
Torque Wrenches 76
Locking Pliers 76
Pliers 76
Hammers 76-77
Levels 77
Tape Measures 77



Water Heater Parts
Anode Rods 78
Dip Tubes 78
Drain Valves 78
T&P Relief Valves 78
Thermal Expansion Tanks 78
Thermocouples 78

Engineering Data 79-109
Cross References 110-112
Index 113-118

YOUR SUPPLIES ARE JUST A FEW MOUSE CLICKS AWAY.

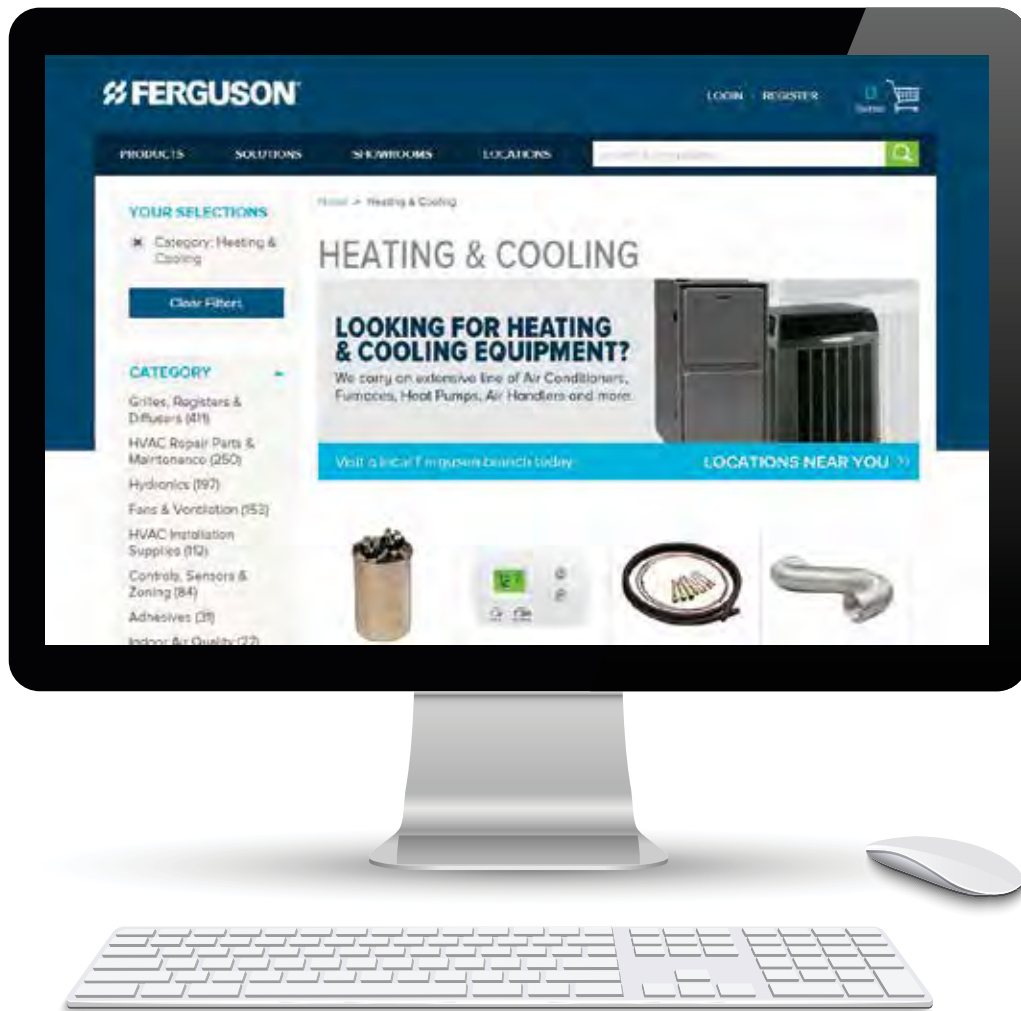

VISIT FERGUSON.COM TO VIEW OUR FULL SELECTION OF PRODUCTS AND SERVICES.



Pages 7-38

Stamped Steel Sidewall/Ceiling Registers 1-Way

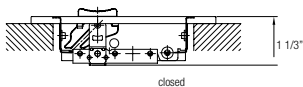
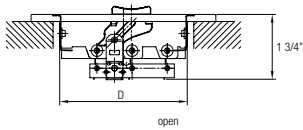
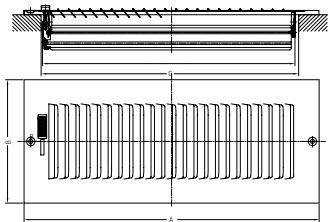

- All-steel construction
- 1/2" spaced fins set at 40°
- Used for ceiling or sidewall installation
- Ideal for shallow duct installations
- 1-way deflection
- Multi-shutter damper
- 1 5/8" depth when fully opened
- Interlocking damper louvers for positive shut-off
- Color/Finish: White

See P. 79 for performance data

SKU	Size	A	B	C	D
PS1WWXP	8" x 4"	9.75"	5.75"	7.9"	3.7"
PS1WW10U	10" x 6"	11.75"	7.75"	9.9"	5.63"
PS1WW12U	12" x 6"	13.75"	7.75"	11.9"	5.63"
PS1WW14U	14" x 6"	15.75"	7.75"	13.9"	5.63"
PS1WW16U	16" x 6"	17.75"	7.75"	15.9"	5.63"

Horizontal dimension listed first

Stamped Steel Sidewall/Ceiling Registers 2-Way

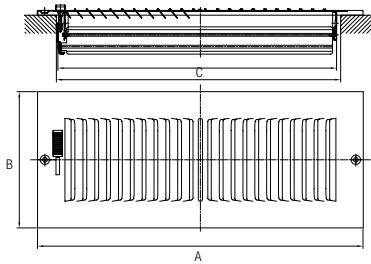

- All-steel welded construction
- 1/2" spaced fins at 40°
- For both sidewall and ceiling applications
- Ideal for shallow duct installation
- 2-way air pattern
- Integral multi-shutter damper
- Screws included
- Color/Finish: White

See P. 79 for performance data

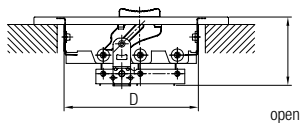

open

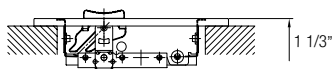

closed

SKU	Size	A	B	C	D
PS2WWUP	6" x 4"	7.75"	5.75"	5.9"	3.7"
PS2WWUU	6" x 6"	7.75"	7.75"	5.9"	5.63"
PS2WWXP	8" x 4"	9.75"	5.75"	7.9"	3.7"
PS2WWXU	8" x 6"	9.75"	7.75"	7.9"	5.63"
PS2WWXX	8" x 8"	9.75"	9.75"	7.9"	7.63"
PS2WW10P	10" x 4"	11.75"	5.75"	9.9"	3.7"
PS2WW10S	10" x 5"	11.75"	6.75"	9.9"	4.63"
PS2WW10U	10" x 6"	11.75"	7.75"	9.9"	5.63"
PS2WW10X	10" x 8"	11.75"	9.75"	9.9"	7.63"
PS2WW1010	10" x 10"	11.75"	11.75"	9.9"	9.67"
PS2WW12P	12" x 4"	13.75"	5.75"	11.9"	3.7"
PS2WW12S	12" x 5"	13.75"	6.75"	11.9"	4.63"
PS2WW12U	12" x 6"	13.75"	7.75"	11.9"	5.63"
PS2WW12X	12" x 8"	13.75"	9.75"	11.9"	7.63"
PS2WW1210	12" x 10"	13.75"	11.75"	11.75"	9.63"
PS2WW1212	12" x 12"	13.75"	13.75"	11.9"	11.63"
PS2WW14P	14" x 4"	15.75"	5.75"	13.9"	3.7"
PS2WW14U	14" x 6"	15.75"	7.75"	13.9"	5.63"
PS2WW14X	14" x 8"	15.75"	9.75"	13.9"	7.63"
PS2WW1410	14" x 10"	15.75"	11.75"	13.9"	9.67"
PS2WW16P	16" x 4"	17.75"	5.75"	15.75"	3.63"
PS2WW16U	16" x 6"	17.75"	7.75"	15.9"	5.63"
PS2WW16X	16" x 8"	17.75"	9.75"	15.9"	7.63"
PS2WW18U	18" x 6"	19.75"	7.75"	17.9"	5.63"
PS2WW18X	18" x 8"	19.75"	9.75"	13.9"	7.63"
PS2WW20U	20" x 6"	21.75"	7.75"	19.9"	5.63"
PS2WW20X	20" x 8"	21.75"	9.75"	19.9"	7.63"
PS2WW24U	24" x 6"	25.75"	7.75"	23.9"	5.63"
PS2WW24X	24" x 8"	25.75"	9.75"	23.9"	7.63"

Horizontal dimension listed first

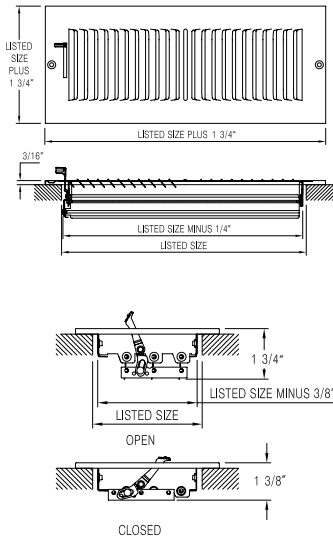

Stamped Steel Sidewall/Ceiling Registers 2-Way, Metal Lever



- All-steel welded construction
- 1/2" spaced fins at 40°
- For both sidewall and ceiling applications
- Ideal for shallow duct installation
- 2-way air pattern
- Integral multi-shutter damper
- Metal lever damper operator
- Screws included
- Color/Finish: White

See P. 82 for performance data

SKU	Size	A	B	C	D
PS2WWMLXP	8" x 4"	9.75"	5.75"	7.9"	3.7"
PS2WWMLXU	8" x 6"	9.75"	7.75"	7.9"	5.63"
PS2WWML10P	10" x 4"	11.75"	5.75"	9.9"	3.7"
PS2WWML10U	10" x 6"	11.75"	7.75"	9.9"	5.63"
PS2WWML10X	10" x 8"	11.75"	9.75"	9.9"	7.63"
PS2WWML12P	12" x 4"	13.75"	5.75"	11.9"	3.7"
PS2WWML12U	12" x 6"	13.75"	7.75"	11.9"	5.63"
PS2WWML12X	12" x 8"	13.75"	9.75"	11.9"	7.63"
PS2WWML14P	14" x 4"	15.75"	5.75"	13.9"	3.7"
PS2WWML14U	14" x 6"	15.75"	7.75"	13.9"	5.63"
PS2WWML14X	14" x 8"	15.75"	9.75"	13.9"	7.63"
PS2WWML16U	16" x 6"	17.75"	7.75"	15.9"	5.63"

Horizontal dimension listed first



What do you get when you buy PROSELECT products?

- High Quality
- Heavy Gauge Metal
- E-Coated and Powder Coated
- Scratch Resistant
- Smooth Damper Operation
- Premium Packaging

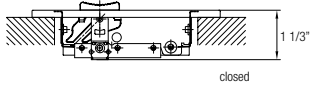
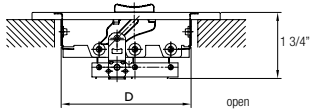
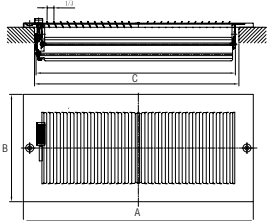
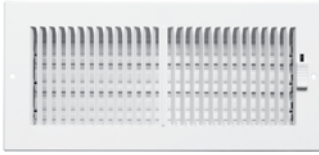

Stamped Steel Sidewall/Ceiling Registers 2-Way, 1/3" Fin



- All-steel welded construction
- 1/3" spaced fins at 20°
- For both sidewall and ceiling applications
- Ideal for shallow duct installation
- 2-way air pattern
- Integral multi-shutter damper
- Screws included
- Color/Finish: White

See P. 80 for performance data

SKU	Size	A	B	C	D
PS2W3WUP	6" x 4"	7.25"	5.25"	5.8"	3.63"
PS2W3WUU	6" x 6"	7.25"	7.25"	5.9"	5.63"
PS2W3WXP	8" x 4"	9.25"	5.25"	7.8"	5.63"
PS2W3WXU	8" x 6"	9.25"	7.25"	7.8"	7.63"
PS2W3WXX	8" x 8"	9.25"	9.25"	7.9"	7.63"
PS2W3W10P	10" x 4"	11.25"	5.25"	9.9"	3.7"
PS2W3W10U	10" x 6"	11.25"	7.25"	9.9"	5.63"
PS2W3W10X	10" x 8"	11.25"	9.25"	9.8"	7.63"
PS2W3W12P	12" x 4"	13.25"	5.25"	11.9"	3.7"
PS2W3W12U	12" x 6"	13.25"	7.25"	11.9"	5.63"
PS2W3W12X	12" x 8"	13.25"	9.25"	11.8"	7.63"
PS2W3W1210	12" x 10"	13.25"	11.25"	11.8"	9.63"
PS2W3W1212	12" x 12"	13.25"	13.25"	11.8"	11.63"
PS2W3W14P	14" x 4"	15.25"	5.25"	13.9"	3.7"
PS2W3W14U	14" x 6"	15.25"	7.25"	13.9"	5.63"
PS2W3W14X	14" x 8"	15.25"	9.25"	13.9"	7.63"
PS2W3W16U	16" x 6"	17.25"	7.25"	15.8"	5.63"
PS2W3W16X	16" x 8"	17.25"	9.25"	15.8"	7.63"
PS2W3W24U	24" x 6"	25.25"	7.25"	23.8"	5.63"
PS2W3W30U	30" x 6"	31.25"	7.25"	29.8"	5.63"

Horizontal dimension listed first



Offered exclusively by Ferguson®

Gas Fired Cast Iron Water Boilers

Standard Features:

- B-Vent/L-Vent
- Hydrolevel® Hydrostat™ advanced controls with built-in LWCO, outdoor reset option available
- Built-in draft diverter fits in low spaces
- Industry standard tapping locations; provides drop-in replacement in most installations
- Can be installed on combustible floors
- Reliable cast iron heat exchanger with limited lifetime warranty
- 37,000 - 299,000 BTUs available in 9 sizes
- AFUE%: 82
- Steam and oil models also available

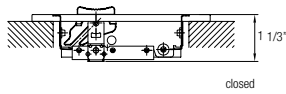
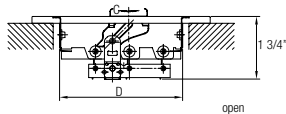
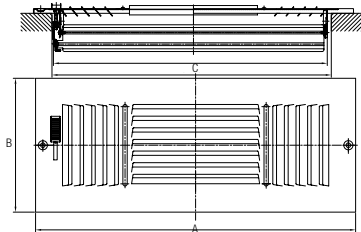

Stamped Steel Sidewall/Ceiling Registers 3-Way



- All-steel welded construction
- 1/2" spaced fins at 40°
- For both sidewall and ceiling applications
- 3-way air pattern
- Ideal for shallow duct installation
- Integral multi-shutter damper
- Screws included
- Color/Finish: White

See P. 80 for performance data

SKU	Size	A	B	C	D
PS3WWUU	6" x 6"	7.75"	7.75"	5.9"	5.63"
PS3WWXP	8" x 4"	9.75"	5.75"	7.9"	3.7"
PS3WWXU	8" x 6"	9.75"	7.75"	7.9"	5.63"
PS3WWXX	8" x 8"	9.75"	9.75"	7.9"	7.63"
PS3WW10P	10" x 4"	11.75"	5.75"	9.9"	3.7"
PS3WW10U	10" x 6"	11.75"	7.75"	9.9"	5.63"
PS3WW10X	10" x 8"	11.75"	9.75"	9.9"	7.63"
PS3WW1010	10" x 10"	11.75"	11.75"	9.9"	9.67"
PS3WW12P	12" x 4"	13.75"	5.75"	11.9"	3.7"
PS3WW12U	12" x 6"	13.75"	7.75"	11.9"	5.63"
PS3WW12X	12" x 8"	13.75"	9.75"	11.9"	7.63"
PS3WW1212	12" x 12"	13.75"	13.75"	11.9"	11.67"
PS3WW14P	14" x 4"	15.75"	5.75"	13.9"	3.7"
PS3WW14U	14" x 6"	15.75"	7.75"	13.9"	5.63"
PS3WW14X	14" x 8"	15.75"	9.75"	13.9"	7.63"
PS3WW1410	14" x 10"	15.75"	11.75"	13.9"	9.67"
PS3WW1414	14" x 14"	15.75"	15.75"	13.9"	11.65"
PS3WW16X	16" x 8"	17.75"	9.75"	15.9"	7.63"

Horizontal dimension listed first

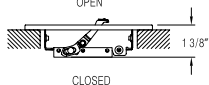
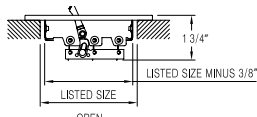
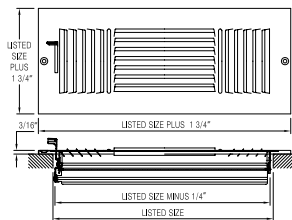

Stamped Steel Sidewall/Ceiling Registers 3-Way, Metal Lever



- Steel construction
- 1/2" spaced fins at 40°
- For both sidewall and ceiling applications
- 3-way air pattern
- Integral multi-shutter damper
- Metal lever damper operator
- Color/Finish: White

See P. 81 for performance data

SKU	Size	A	B	C	D
PS3WWMLXP	8" x 4"	9.75"	5.75"	7.5"	3.5"
PS3WWMLXX	8" x 8"	9.75"	9.75"	7.5"	7.5"
PS3WWML10P	10" x 4"	11.75"	5.75"	9.5"	3.5"
PS3WWML10U	10" x 6"	11.75"	7.75"	9.5"	5.5"
PS3WWML12U	12" x 6"	13.75"	7.75"	11.5"	5.5"
PS3WWML12X	12" x 8"	13.75"	9.75"	11.5"	7.5"
PS3WWML14U	14" x 6"	15.75"	7.75"	13.5"	5.5"
PS3WWML14X	14" x 8"	15.75"	9.75"	13.5"	7.5"
PS3WWML1410	14" x 10"	15.75"	11.75"	13.5"	9.5"

Horizontal dimension listed first

Stamped Steel Sidewall/Ceiling Registers 3-Way, 1/3" Fin

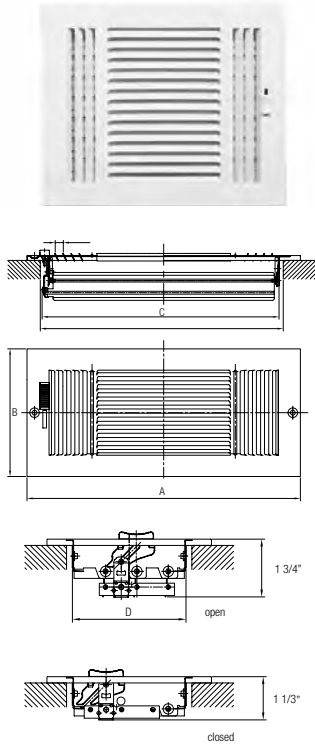

- All-steel welded construction
- 1/3" spaced fins at 20°
- For both sidewall and ceiling applications
- Ideal for shallow duct installations
- 3-way air pattern
- Integral multi-shutter damper
- Color/Finish: White

See P. 81 for performance data

SKU	Size	A	B	C	D
PS3W3WXP	8" x 4"	9.25"	5.25"	7.8"	3.63"
PS3W3W10P	10" x 4"	11.25"	5.25"	9.8"	3.63"
PS3W3W10U	10" x 6"	11.25"	7.25"	9.8"	5.63"
PS3W3W12P	12" x 4"	13.25"	5.25"	11.8"	3.63"
PS3W3W12U	12" x 6"	13.25"	7.25"	11.8"	5.63"
PS3W3W14U	14" x 6"	15.25"	7.25"	13.8"	5.63"

Horizontal dimension listed first

Stamped Steel Sidewall/Ceiling Registers 4-Way

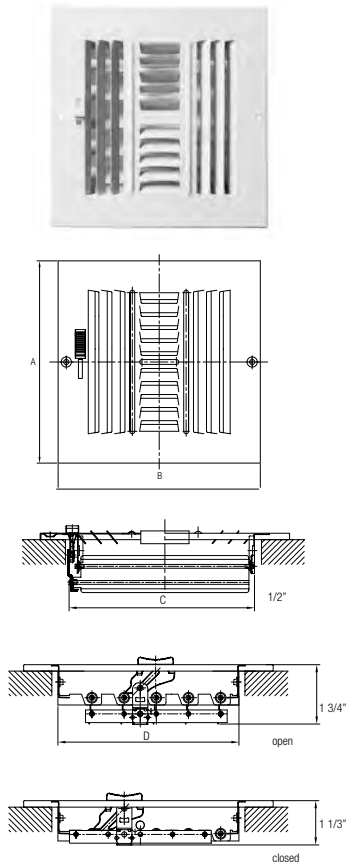

- All-steel welded construction
- 1/2" spaced fins at 40°
- For both sidewall and ceiling applications
- Ideal for shallow duct installation
- 4-way air pattern
- Integral multi-shutter damper
- Screws included
- Color/Finish: White

See P. 79 for performance data

SKU	Size	A	B	C	D
PS4WWUU	6" x 6"	7.75"	7.75"	5.9"	5.63"
PS4WWXX	8" x 8"	9.75"	9.75"	7.9"	7.63"
PS4WW1010	10" x 10"	11.75"	11.75"	9.9"	9.67"
PS4WW1212	12" x 12"	13.75"	13.75"	11.9"	11.67"
PS4WW1414	14" x 14"	15.75"	15.75"	13.9"	11.65"
PS4WW1616	16" x 16"	17.75"	17.75"	15.75"	15.63"
PS4WW1818	18" x 18"	19.75"	19.75"	17.75"	17.63"

Horizontal dimension listed first

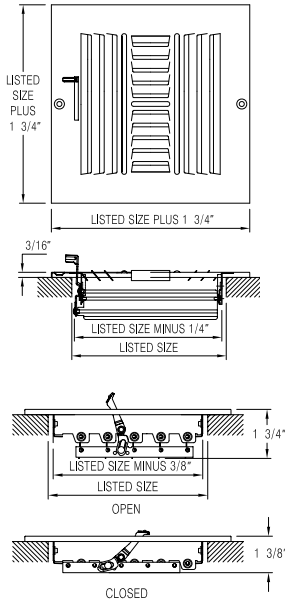

Stamped Steel Sidewall/Ceiling Registers 4-Way, Metal Lever



- All-steel welded construction
- 1/2" spaced fins at 40°
- For both sidewall and ceiling applications
- Ideal for shallow duct installation
- 4-way air pattern
- Metal lever damper operator
- Integral multi-shutter damper
- Screws included
- Color/Finish: White

See P. 82 for performance data

SKU	Size	A	B	C	D
PS4WWMLUU	6" x 6"	7.75"	7.75"	5.5"	5.5"
PS4WWMLXX	8" x 8"	9.75"	9.75"	7.5"	7.5"
PS4WWML1010	10" x 10"	11.75"	11.75"	9.5"	9.5"
PS4WWML1212	12" x 12"	13.75"	13.75"	11.5"	11.5"
PS4WWML1414	14" x 14"	15.75"	15.75"	13.5"	13.5"

Horizontal dimension listed first

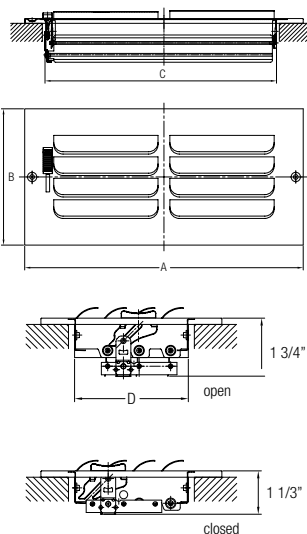

Stamped Steel Curved Blade Registers 1-Way



- All-steel welded curved blade construction
- For both sidewall and ceiling applications
- 1-way air pattern
- Integral multi-shutter damper
- Screws included
- Color/Finish: White

See P. 81 for performance data

SKU	Size	A	B	C	D
PS1CWXP	8" x 4"	9.75"	5.75"	7.9"	3.7"
PS1CW10P	10" x 4"	11.75"	5.75"	9.9"	3.63"
PS1CW10U	10" x 6"	11.75"	7.75"	9.9"	5.63"
PS1CW10X	10" x 8"	11.75"	9.75"	9.9"	7.63"
PS1CW12P	12" x 4"	13.75"	5.75"	11.9"	3.7"
PS1CW12U	12" x 6"	13.75"	7.75"	11.9"	5.63"
PS1CW12X	12" x 8"	13.75"	9.75"	11.9"	7.63"
PS1CW1212	12" x 12"	13.75"	11.75"	11.9"	11.63"
PS1CW14U	14" x 6"	15.75"	7.75"	13.9"	5.63"
PS1CW14X	14" x 8"	15.75"	9.75"	13.9"	7.63"

Horizontal dimension listed first

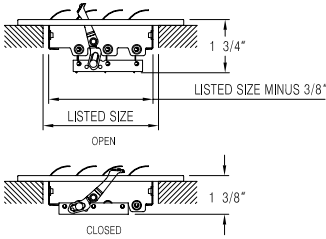
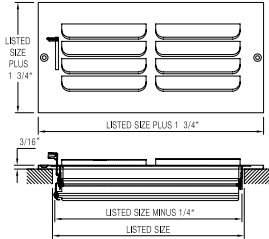

Stamped Steel Curved Blade Registers 1-Way, Metal Lever



- All-steel welded curved blade construction
- For both sidewall and ceiling applications
- 1-way air pattern
- Metal lever damper operator
- Integral multi-shutter damper
- Screws included
- Color/Finish: White

See P. 81 for performance data

SKU	Size	A	B	C	D
PS1CWMLXP	8" x 4"	9.75"	5.75"	7.9"	3.7"
PS1CWML10U	10" x 6"	11.75"	7.75"	9.9"	5.63"
PS1CWML12U	12" x 6"	13.75"	7.75"	11.9"	5.63"
PS1CWML12X	12" x 8"	13.75"	9.75"	11.9"	7.63"
PS1CWML1212	12" x 12"	13.75"	11.75"	11.9"	11.63"
PS1CWML14X	14" x 8"	15.75"	9.75"	13.9"	7.63"

Horizontal dimension listed first

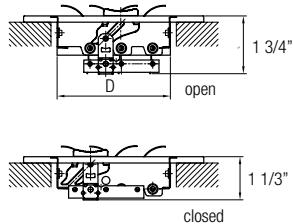
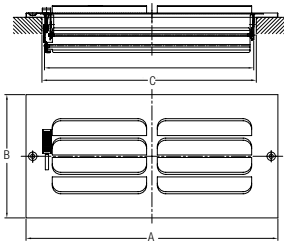

Stamped Steel Curved Blade Registers 2-Way



- All-steel welded curved blade construction
- For both sidewall and ceiling applications
- 2-way air pattern
- Integral multi-shutter damper
- Screws included
- Color/Finish: White

See P. 81 for performance data

SKU	Size	A	B	C	D
PS2CW10U	10" x 6"	11.75"	7.75"	9.75"	5.63"
PS2CW1010	10" x 10"	11.75"	11.75"	9.75"	9.63"
PS2CW12U	12" x 6"	13.75"	7.75"	11.75"	5.63"
PS2CW12X	12" x 8"	13.75"	9.75"	11.75"	7.63"
PS2CW1212	12" x 12"	13.75"	13.75"	11.75"	11.63"

Horizontal dimension listed first

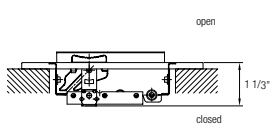
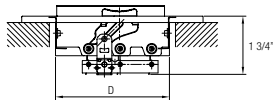
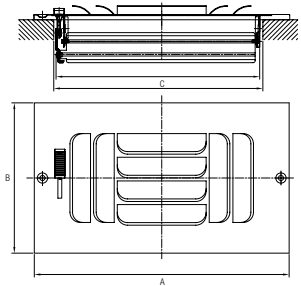

Stamped Steel Curved Blade Registers 3-Way



- All-steel welded curved blade construction
- For both sidewall and ceiling applications
- 3-way air pattern
- Integral multi-shutter damper
- Screws included
- Color/Finish: White

See P. 82 for performance data

SKU	Size	A	B	C	D
PS3CWUU	6" x 6"	7.75"	7.75"	5.9"	5.7"
PS3CWXP	8" x 4"	9.75"	5.75"	7.9"	3.7"
PS3CW XU	8" x 6"	9.75"	7.75"	7.9"	5.63"
PS3CWXX	8" x 8"	9.75"	9.75"	7.9"	7.63"
PS3CW10P	10" x 4"	11.75"	5.75"	9.9"	3.7"
PS3CW10U	10" x 6"	11.75"	7.75"	9.9"	5.63"
PS3CW10X	10" x 8"	11.75"	9.75"	9.9"	7.63"
PS3CW1010	10" x 10"	11.75"	11.75"	9.9"	9.63"
PS3CW12P	12" x 4"	13.75"	5.75"	11.9"	3.7"
PS3CW12U	12" x 6"	13.75"	7.75"	11.9"	5.63"
PS3CW12X	12" x 8"	13.75"	9.75"	11.9"	7.63"
PS3CW1212	12" x 12"	13.75"	13.75"	11.9"	11.63"
PS3CW14P	14" x 4"	15.75"	5.75"	13.9"	3.7"
PS3CW14U	14" x 6"	15.75"	7.75"	13.9"	5.63"
PS3CW14X	14" x 8"	15.75"	9.75"	13.9"	7.63"

Horizontal dimension listed first

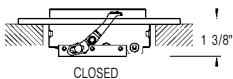
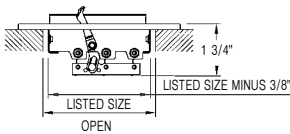
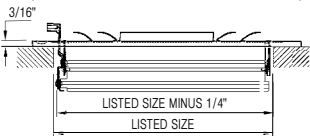
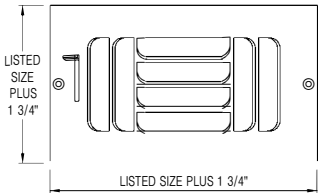

Stamped Steel Curved Blade Registers 3-Way, Metal Lever



- All-steel welded curved blade construction
- For both sidewall and ceiling applications
- 3-way air pattern
- Metal lever damper operator
- Integral multi-shutter damper
- Screws included
- Color/Finish: White

See P. 81 for performance data

SKU	Size	A	B	C	D
PS3CWMLXP	8" x 4"	9.75"	5.75"	7.9"	3.7"
PS3CWML10U	10" x 6"	11.75"	7.75"	9.9"	5.63"
PS3CWML12U	12" x 6"	13.75"	7.75"	11.9"	5.63"
PS3CWML12X	12" x 8"	13.75"	9.75"	11.9"	7.63"

Horizontal dimension listed first

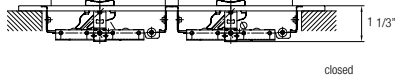
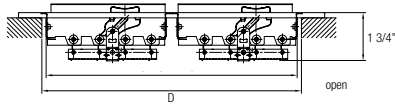
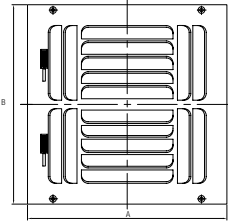

Stamped Steel Curved Blade Registers 4-Way



- All-steel welded curved blade construction
- For both sidewall and ceiling applications
- 4-way air pattern
- Integral multi-shutter damper
- 10" and higher requires two dampers
- Screws included
- Color/Finish: White

See P. 82 for performance data

SKU	Size	A	B	C	D
PS4CWUU	6" x 6"	7.75"	7.75"	5.9"	5.63"
PS4CWXX	8" x 8"	9.75"	9.75"	7.9"	7.63"
PS4CW1010	10" x 10"	11.75"	11.75"	9.9"	9.67"
PS4CW1212	12" x 12"	13.75"	13.75"	11.9"	11.67"
PS4CW1414	14" x 14"	15.75"	15.75"	13.9"	13.67"

Horizontal dimension listed first

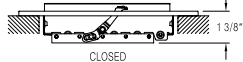
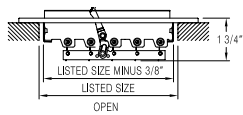
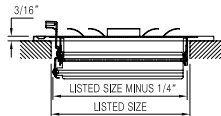
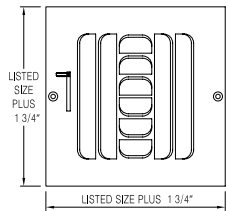

Stamped Steel Curved Blade Registers 4-Way, Metal Lever



- All-steel welded curved blade construction
- For both sidewall and ceiling applications
- 4-way air pattern
- Integral multi-shutter damper
- 10" and higher requires two dampers
- Metal lever damper operator
- Screws included
- Color/Finish: White

See P. 82 for performance data

SKU	Size	A	B	C	D
PS4CWMLXX	8" x 8"	9.75"	9.75"	7.9"	7.63"
PS4CWML1010	10" x 10"	11.75"	11.75"	9.9"	9.67"
PS4CWML1212	12" x 12"	13.75"	13.75"	11.9"	11.67"

Horizontal dimension listed first

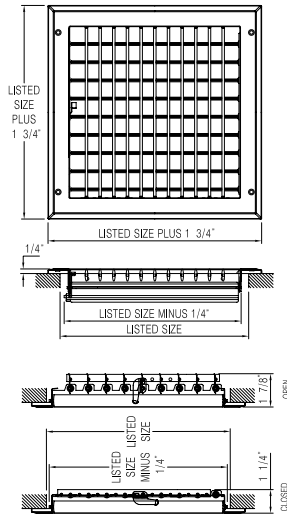

Aluminum Sidewall Registers



- Aluminum construction
- Adjustable straight fins
- Stamped face margins
- Multi-shutter damper
- Color/Finish: White

See P. 94-99 for performance data

SKU	Size	A	B	C	D
PSAASWUU	6" x 6"	7.75"	7.75"	5.74"	5.46"
PSAASWXP	8" x 4"	9.75"	5.75"	7.74"	3.46"
PSAASWXU	8" x 6"	9.75"	7.75"	7.74"	5.46"
PSAASWXX	8" x 8"	9.75"	9.75"	7.74"	7.46"
PSAASW10P	10" x 4"	11.75"	5.75"	9.74"	3.46"
PSAASW10U	10" x 6"	11.75"	7.75"	9.74"	5.46"
PSAASW10X	10" x 8"	11.75"	9.75"	9.74"	7.46"
PSAASW1010	10" x 10"	11.75"	11.75"	9.74"	9.46"
PSAASW12P	12" x 4"	13.75"	5.75"	11.74"	3.46"
PSAASW12U	12" x 6"	13.75"	7.75"	11.74"	5.46"
PSAASW12X	12" x 8"	13.75"	9.75"	11.74"	7.46"
PSAASW1212	12" x 12"	13.75"	13.75"	11.74"	11.46"
PSAASW14P	14" x 4"	15.75"	5.75"	13.74"	3.46"
PSAASW14U	14" x 6"	15.75"	7.75"	13.74"	5.46"
PSAASW14X	14" x 8"	15.75"	9.75"	13.74"	7.46"
PSAASW1410	14" x 10"	15.75"	11.75"	13.74"	9.46"
PSAASW1414	14" x 14"	15.75"	15.75"	13.74"	13.46"
PSAASW16P	16" x 4"	17.75"	5.75"	15.74"	3.46"
PSAASW16U	16" x 6"	17.75"	7.75"	15.74"	5.46"
PSAASW16X	16" x 8"	17.75"	9.75"	15.74"	7.46"

SKU	Size	A	B	C	D
PSAASW1610	16" x 10"	17.75"	11.75"	15.74"	9.46"
PSAASW1616	16" x 16"	17.75"	17.75"	15.74"	15.46"
PSAASW18U	18" x 6"	19.75"	7.75"	17.74"	5.46"
PSAASW18X	18" x 8"	19.75"	9.75"	17.74"	7.46"
PSAASW1810	18" x 10"	19.75"	11.75"	17.74"	9.46"
PSAASW1812	18" x 12"	19.75"	13.75"	17.74"	11.46"
PSAASW1818	18" x 18"	19.75"	19.75"	17.74"	17.46"
PSAASW20P	20" x 4"	21.75"	5.75"	19.74"	3.46"
PSAASW20U	20" x 6"	21.75"	7.75"	19.74"	5.46"
PSAASW20X	20" x 8"	21.75"	9.75"	19.74"	7.46"
PSAASW2020	20" x 20"	21.75"	21.75"	19.74"	19.46"
PSAASW24P	24" x 4"	25.75"	5.75"	23.74"	3.46"
PSAASW24U	24" x 6"	25.75"	7.75"	23.74"	5.46"
PSAASW24X	24" x 8"	25.75"	9.75"	23.74"	7.46"
PSAASW2412	24" x 12"	25.75"	13.75"	23.74"	11.46"
PSAASW2414	24" x 14"	25.75"	15.75"	23.74"	13.46"
PSAASW28U	28" x 6"	29.75"	7.75"	27.74"	5.46"
PSAASW28X	28" x 8"	29.75"	9.75"	27.74"	7.46"
PSAASW30U	30" x 6"	31.75"	7.75"	29.74"	5.46"
PSAASW30X	30" x 8"	31.75"	9.75"	29.74"	7.46"

Horizontal dimension listed first



GLOVES | P. 66-68

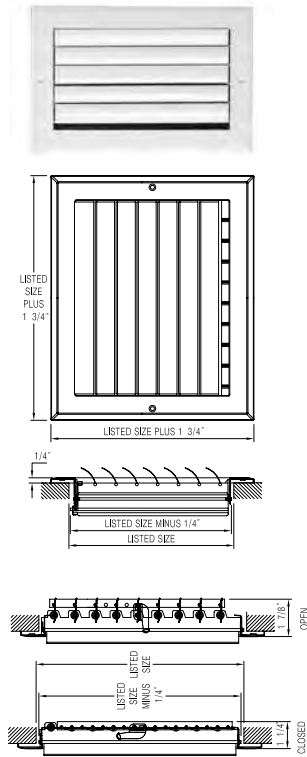

Aluminum Curved Sidewall/Ceiling Registers 1-Way



- Aluminum construction
- For both sidewall and ceiling applications
- 1-way air pattern
- Adjustable curved blades
- Multi-shutter damper
- Color/Finish: White

See P. 100 for performance data

SKU	Size	A	B	C	D
PSA1CWUU	6" x 6"	7.75"	7.75"	5.74"	5.47"
PSA1CWXP	8" x 4"	9.75"	5.75"	7.74"	3.47"
PSA1CWXX	8" x 8"	9.75"	9.75"	7.74"	7.47"
PSA1CW10P	10" x 4"	11.75"	5.75"	9.74"	3.47"
PSA1CW10U	10" x 6"	11.75"	7.75"	9.74"	5.47"
PSA1CW10X	10" x 8"	11.75"	9.75"	9.74"	7.47"
PSA1CW1010	10" x 10"	11.75"	11.75"	9.74"	9.47"
PSA1CW12P	12" x 4"	13.75"	5.75"	11.74"	3.47"
PSA1CW12U	12" x 6"	13.75"	7.75"	11.74"	5.47"
PSA1CW12X	12" x 8"	13.75"	9.75"	11.74"	7.47"
PSA1CW1212	12" x 12"	13.75"	13.75"	11.74"	11.47"
PSA1CW14U	14" x 6"	15.75"	7.75"	13.74"	5.47"
PSA1CW14X	14" x 8"	15.75"	9.75"	13.74"	7.47"

Horizontal dimension listed first

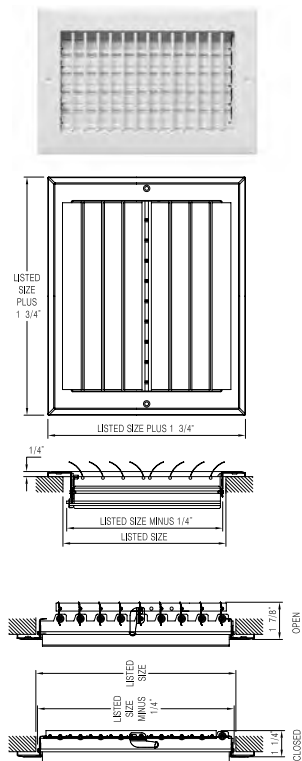

Aluminum Curved Sidewall/Ceiling Registers 2-Way



- Aluminum construction
- For both sidewall and ceiling applications
- 2-way air pattern
- Adjustable curved blades
- Multi-shutter damper
- Color/Finish: White

See P. 100 for performance data

SKU	Size	A	B	C	D
PSA2CWXX	8" x 8"	9.75"	9.75"	7.74"	7.47"
PSA2CW10U	10" x 6"	11.75"	7.75"	9.75"	5.75"
PSA2CW10X	10" x 8"	11.75"	9.75"	9.74"	7.47"
PSA2CW1010	10" x 10"	11.75"	11.75"	9.75"	9.75"
PSA2CW12U	12" x 6"	13.75"	7.75"	11.75"	5.75"
PSA2CW12X	12" x 8"	13.75"	9.75"	11.75"	7.75"
PSA2CW1212	12" x 12"	13.75"	13.75"	11.75"	11.75"
PSA2CW14X	14" x 8"	15.75"	9.75"	13.74"	7.47"

Horizontal dimension listed first

Aluminum Curved Sidewall/Ceiling Registers 3-Way



- Aluminum construction
- For both sidewall and ceiling applications
- 3-way air pattern
- Adjustable curved blades
- Multi-shutter damper
- Color/Finish: White

See P. 100 for performance data

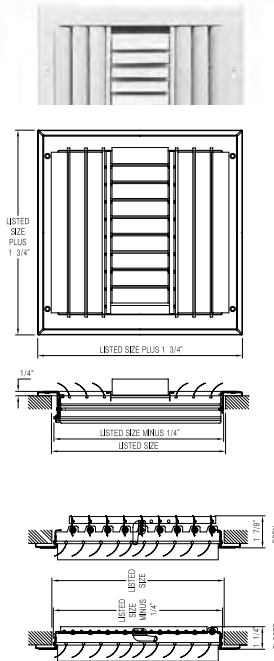

SKU	Size	A	B	C	D
PSA3CWUU	6" x 6"	7.75"	7.75"	5.74"	5.71"
PSA3CWXP	8" x 4"	9.75"	5.75"	7.74"	3.71"
PSA3CW XU	8" x 6"	9.75"	7.75"	7.74"	5.71"
PSA3CWXX	8" x 8"	9.75"	9.75"	7.74"	7.71"
PSA3CW10P	10" x 4"	11.75"	5.75"	9.74"	3.71"
PSA3CW10U	10" x 6"	11.75"	7.75"	9.74"	5.71"
PSA3CW1010	10" x 10"	11.75"	11.75"	9.74"	9.71"
PSA3CW12U	12" x 6"	13.75"	7.75"	11.74"	5.71"
PSA3CW12X	12" x 8"	13.75"	9.75"	11.74"	7.71"
PSA3CW1212	12" x 12"	13.75"	13.75"	11.74"	11.71"
PSA3CW14P	14" x 4"	15.75"	5.75"	13.74"	3.71"
PSA3CW14U	14" x 6"	15.75"	7.75"	13.74"	5.71"
PSA3CW14X	14" x 8"	15.75"	9.75"	13.74"	7.71"
PSA3CW1414	14" x 14"	15.75"	15.75"	13.74"	13.71"

Horizontal dimension listed first

Aluminum Curved Sidewall/Ceiling Registers 4-Way



- Aluminum construction
- For both sidewall and ceiling applications
- 4-way air pattern
- Adjustable curved blades
- Multi-shutter damper
- Color/Finish: White

See P. 100 for performance data

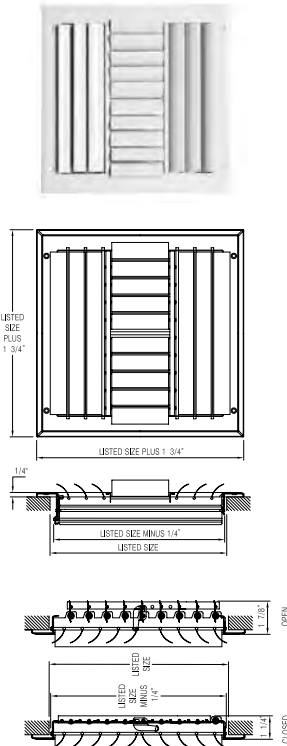

SKU	Size	A	B	C	D
PSA4CWUU	6" x 6"	7.75"	7.75"	5.74"	5.71"
PSA4CWXX	8" x 8"	9.75"	9.75"	7.74"	7.71"
PSA4CW1010	10" x 10"	11.75"	11.75"	9.74"	9.71"
PSA4CW1212	12" x 12"	13.75"	13.75"	11.74"	11.71"
PSA4CW1414	14" x 14"	15.74"	15.75"	13.74"	13.71"
PSA4CW1616	16" x 16"	17.75"	17.75"	15.74"	15.71"

Horizontal dimension listed first

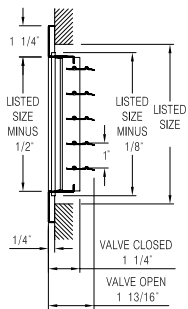
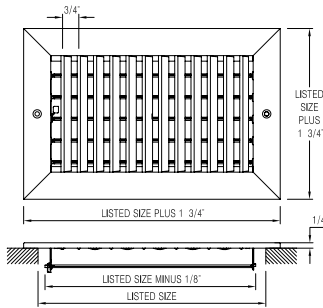
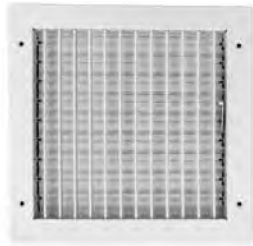

Vertical Blade Supply Registers



- All-steel construction
- Vertical adjustable face bars
- Horizontal multi-shutter damper
- Color/Finish: White

See P. 83-84 for performance data

SKU	Size	A	B	C	D
PSVAFWUU	6" x 6"	7.84"	7.88"	5.72"	5.43"
PSVAFWXP	8" x 4"	9.84"	5.88"	7.72"	3.43"
PSVAFWXU	8" x 6"	9.84"	7.88"	7.72"	5.43"
PSVAFWXX	8" x 8"	9.84"	9.88"	7.72"	7.43"
PSVAFW10P	10" x 4"	11.84"	5.88"	9.72"	3.43"
PSVAFW10U	10" x 6"	11.84"	7.88"	9.72"	5.43"
PSVAFW10X	10" x 8"	11.84"	9.88"	9.72"	7.43"
PSVAFW1010	10" x 10"	11.84"	11.88"	9.72"	9.43"
PSVAFW12P	12" x 4"	13.84"	5.88"	11.72"	3.43"
PSVAFW12U	12" x 6"	13.84"	7.88"	11.72"	5.43"
PSVAFW12X	12" x 8"	13.84"	9.88"	11.72"	7.43"
PSVAFW1210	12" x 10"	13.84"	11.88"	11.72"	9.43"
PSVAFW1212	12" x 12"	13.84"	13.88"	11.72"	11.43"
PSVAFW14P	14" x 4"	15.84"	5.88"	13.72"	3.43"
PSVAFW14U	14" x 6"	15.84"	7.88"	13.72"	5.43"
PSVAFW14X	14" x 8"	15.84"	9.88"	13.72"	7.43"
PSVAFW1410	14" x 10"	15.84"	11.88"	13.72"	9.43"
PSVAFW1414	14" x 14"	15.84"	15.88"	13.72"	13.43"
PSVAFW16P	16" x 4"	17.84"	5.88"	15.72"	3.43"
PSVAFW16U	16" x 6"	17.84"	7.88"	15.72"	5.43"
PSVAFW16X	16" x 8"	17.84"	9.88"	15.72"	7.43"
PSVAFW1612	16" x 12"	17.84"	5.88"	15.72"	11.43"
PSVAFW1616	16" x 16"	17.84"	17.88"	15.72"	15.43"
PSVAFW18U	18" x 6"	19.84"	7.88"	17.72"	5.43"
PSVAFW18X	18" x 8"	19.84"	9.88"	17.72"	7.43"
PSVAFW1810	18" x 10"	19.84"	11.88"	17.72"	9.43"
PSVAFW1818	18" x 18"	19.84"	19.88"	17.72"	17.43"
PSVAFW20U	20" x 6"	21.84"	7.88"	19.72"	5.43"
PSVAFW20X	20" x 8"	21.84"	9.88"	19.72"	7.43"
PSVAFW2010	20" x 10"	21.84"	11.88"	19.72"	9.43"
PSVAFW2012	20" x 12"	21.84"	13.88"	19.72"	11.43"
PSVAFW2014	20" x 14"	21.84"	15.88"	19.72"	13.43"
PSVAFW2020	20" x 20"	21.84"	21.88"	19.72"	19.43"
PSVAFW24U	24" x 6"	25.84"	7.88"	23.72"	5.43"
PSVAFW24X	24" x 8"	25.84"	9.88"	23.72"	7.43"
PSVAFW2424	24" x 24"	25.84"	25.88"	23.72"	23.43"
PSVAFW30U	30" x 6"	31.84"	7.88"	29.72"	5.43"
PSVAFW3010	30" x 10"	31.84"	11.88"	29.72"	9.43"
PSVAFW3012	30" x 12"	31.84"	13.88"	29.72"	11.43"
PSVAFW3018	30" x 18"	31.84"	19.88"	29.72"	17.43"

Horizontal dimension listed first

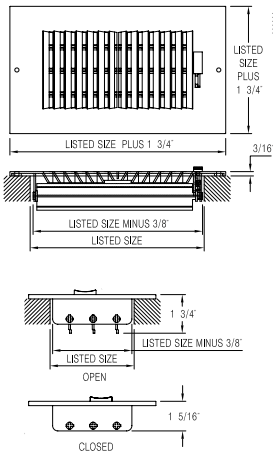

Plastic Sidewall/Ceiling Registers 2-Way



- Engineered polymer construction
- For heating or cooling applications
- 2-way air pattern
- Multi-shutter damper
- Color/Finish: White

See P. 101 for performance data

SKU	Size	A	B	C	D	E	F
PSP2WWUU	6" x 6"	7.75"	7.75"	5.68"	5.68"	5.5"	4.75"
PSP2WWXP	8" x 4"	9.75"	5.75"	7.657"	3.58"	3.52"	6.75"
PSP2WW10X	10" x 8"	11.75"	9.75"	9.642"	7.68"	7.62"	8.75"
PSP2WW12U	12" x 6"	13.75"	7.75"	11.653"	5.58"	5.5"	10.75"
PSP2WW14U	14" x 6"	15.75"	7.75"	13.657"	5.58"	5.5"	12.75"
PSP2WW14X	14" x 8"	15.75"	9.75"	13.657"	7.68"	7.62"	8.75"

Horizontal dimension listed first

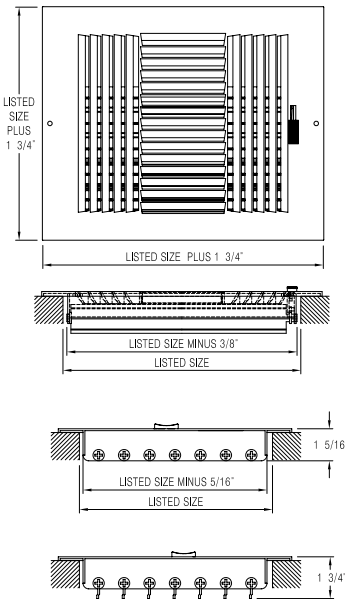

Plastic Sidewall/Ceiling Registers 3-Way



- Engineered polymer construction
- For heating or cooling applications
- 3-way air pattern
- Multi-shutter damper
- Color/Finish: White

See P. 101 for performance data

SKU	Size	A	B	C	D
PSP3WWXP	8" x 4"	9.75"	5.75"	7.66"	3.68"
PSP3WW10U	10" x 6"	11.75"	7.75"	9.66"	5.68"
PSP3WW10X	10" x 8"	11.75"	9.75"	9.66"	7.68"
PSP3WW12U	12" x 6"	13.75"	7.75"	11.66"	5.68"
PSP3WW14X	14" x 8"	15.75"	9.75"	13.66"	7.68"

Horizontal dimension listed first

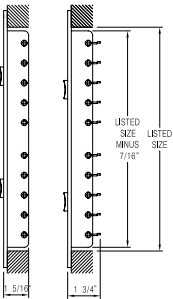
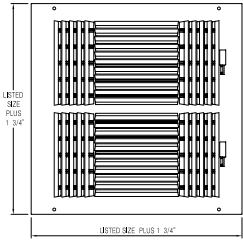

Plastic Sidewall/Ceiling Registers 4-Way



- Engineered polymer construction
- For heating or cooling applications
- 4-way air pattern
- Multi-shutter damper
- Color/Finish: White

See P. 101 for performance data

SKU	Size	A	B	C
PSP4WWUU	6" x 6"	7.75"	7.75"	5.58"
PSP4WWXX	8" x 8"	9.75"	9.75"	7.58"
PSP4WW1010	10" x 10"	11.75"	11.75"	9.58"
PSP4WW1212	12" x 12"	13.75"	13.75"	11.58"

Horizontal dimension listed first



WE CARRY THE FASTENERS YOU NEED



Our vast distribution network and in-depth HVAC knowledge help you get the job done. Shop PROSELECT at FERGUSON.COM.

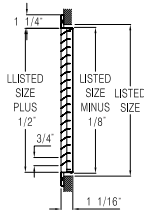
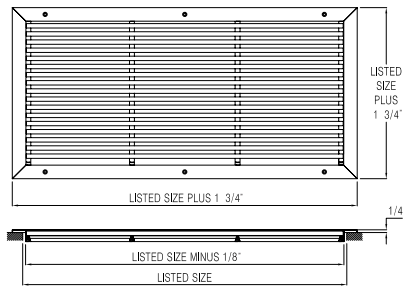
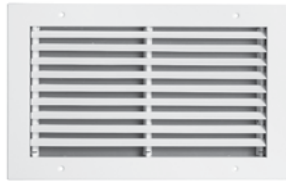

Horizontal Blade Return Grilles



- All-steel construction
- Horizontal space bars set at 35°
- Color/Finish: White

See P. 85 for performance data

SKU	Size	A	B	C	D
PSHFSWUU	6" x 6"	7.751"	7.751"	5.306"	5.306"
PSHFSWXX	8" x 8"	9.751"	9.751"	7.306"	7.306"
PSHFSW10U	10" x 6"	11.751"	7.751"	9.306"	5.306"
PSHFSW1010	10" x 10"	11.751"	11.751"	9.306"	9.306"
PSHFSW12U	12" x 6"	13.751"	7.751"	11.306"	5.306"
PSHFSW12X	12" x 8"	13.751"	9.751"	11.306"	7.306"
PSHFSW1212	12" x 12"	13.751"	13.751"	11.306"	11.306"
PSHFSW14U	14" x 6"	15.751"	7.751"	13.306"	5.306"
PSHFSW14X	14" x 8"	15.751"	9.751"	13.306"	7.306"
PSHFSW1410	14" x 10"	15.751"	11.751"	13.306"	9.306"
PSHFSW1414	14" x 14"	15.751"	15.751"	13.306"	13.306"
PSHFSW16X	16" x 8"	17.751"	9.751"	15.306"	7.306"
PSHFSW1616	16" x 16"	17.751"	17.751"	15.306"	15.306"
PSHFSW1818	18" x 18"	19.751"	19.751"	17.306"	17.306"
PSHFSW20U	20" x 6"	21.751"	7.751"	19.306"	5.306"
PSHFSW20X	20" x 8"	21.751"	9.751"	19.306"	7.306"
PSHFSW2010	20" x 10"	21.751"	11.751"	19.306"	9.306"
PSHFSW2012	20" x 12"	21.751"	13.751"	19.306"	11.306"
PSHFSW2014	20" x 14"	21.751"	15.751"	19.306"	13.306"
PSHFSW2016	20" x 16"	21.751"	17.751"	19.306"	15.306"
PSHFSW2020	20" x 20"	21.751"	21.751"	19.306"	19.306"
PSHFSW2025	20" x 25"	21.751"	26.751"	19.306"	24.306"
PSHFSW24X	24" x 8"	25.751"	9.751"	23.306"	7.306"
PSHFSW2410	24" x 10"	25.751"	11.751"	23.306"	9.306"
PSHFSW2412	24" x 12"	25.751"	13.751"	23.306"	11.306"
PSHFSW2414	24" x 14"	25.751"	15.751"	23.306"	13.306"
PSHFSW2416	24" x 16"	25.751"	17.751"	23.306"	15.306"
PSHFSW2420	24" x 20"	25.751"	21.751"	23.306"	19.306"
PSHFSW2424	24" x 24"	25.751"	25.751"	23.306"	23.306"
PSHFSW2520	25" x 20"	26.751"	21.751"	24.306"	19.306"
PSHFSW30U	30" x 6"	31.751"	7.751"	29.306"	5.306"
PSHFSW30X	30" x 8"	31.751"	9.751"	29.306"	7.306"
PSHFSW3010	30" x 10"	31.751"	11.751"	29.306"	9.306"
PSHFSW3012	30" x 12"	31.751"	13.751"	29.306"	11.306"
PSHFSW3014	30" x 14"	31.751"	15.751"	29.306"	13.306"
PSHFSW3016	30" x 16"	31.751"	17.751"	29.306"	15.306"
PSHFSW3020	30" x 20"	31.751"	21.751"	29.306"	19.306"
PSHFSW3612	36" x 12"	31.751"	13.751"	35.306"	11.306"
PSHFSW3614	36" x 14"	37.751"	35.751"	35.306"	13.306"

Horizontal dimension listed first

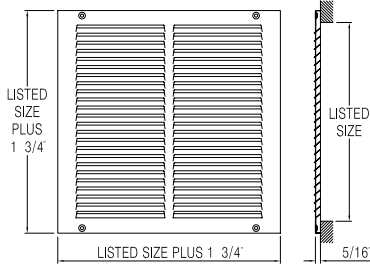

Stamped Aluminum Return Air Grilles



- Aluminum construction
- 1/2" spaced fins at 40°
- 5/16" margin turnback
- Screws included
- Color/Finish: White

See P. 85-87 for performance data

SKU	Size	A	B	C	D
PSARGWUU	6" x 6"	5.5"	7.75"	5.91"	7.75"
PSARGWXX	8" x 8"	7.5"	9.75"	7.91"	9.75"
PSARGW1010	10" x 10"	9.5"	11.75"	9.91"	11.75"
PSARGW1212	12" x 12"	11.5"	13.75"	11.91"	13.75"
PSARGW1410	14" x 10"	13.5"	15.75"	9.91"	11.75"

Horizontal dimension listed first

Want to see
real-time inventory
both locally and in
our shipping centers?

Learn more at
FERGUSON.COM





Stamped Steel Return Air Grilles



- All-steel construction
- 1/2" spaced fins at 40°
- 5/16" margin turnback
- Screws included
- Color/Finish: White

See P. 87-88 for performance data

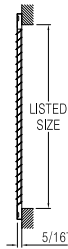

SKU	Size	A	B	C	D
PSRGWUU	6" x 6"	5.5"	7.75"	5.91"	7.75"
PSRGWXP	8" x 4"	7.5"	9.75"	3.91"	5.75"
PSRGWXU	8" x 6"	7.5"	9.75"	5.91"	7.75"
PSRGWXX	8" x 8"	7.5"	9.75"	7.91"	9.75"
PSRGWX14	8" x 14"	7.5"	9.75"	13.91"	15.75"
PSRGW10P	10" x 4"	9.5"	11.75"	3.91"	5.75"
PSRGW10U	10" x 6"	9.5"	11.75"	5.91"	7.75"
PSRGW10X	10" x 8"	9.5"	11.75"	7.91"	9.75"
PSRGW1010	10" x 10"	9.5"	11.75"	9.91"	11.75"
PSRGW1014	10" x 14"	9.5"	11.75"	13.91"	15.75"
PSRGW1020	10" x 20"	9.5"	11.75"	19.91"	21.75"
PSRGW1024	10" x 24"	9.5"	11.75"	23.91"	25.75"
PSRGW12P	12" x 4"	11.5"	13.75"	3.91"	5.75"
PSRGW12U	12" x 6"	11.5"	13.75"	5.91"	7.75"
PSRGW12X	12" x 8"	11.5"	13.75"	7.91"	9.75"
PSRGW1210	12" x 10"	11.5"	13.75"	9.91"	11.75"
PSRGW1212	12" x 12"	11.5"	13.75"	11.91"	13.75"
PSRGW1216	12" x 16"	11.5"	13.75"	15.91"	17.75"
PSRGW1218	12" x 18"	11.5"	13.75"	17.91"	19.75"
PSRGW1220	12" x 20"	11.5"	13.75"	19.91"	21.75"
PSRGW1224	12" x 24"	11.5"	13.75"	23.91"	25.75"
PSRGW1230	12" x 30"	11.5"	13.75"	29.91"	31.75"
PSRGW14P	14" x 4"	13.5"	15.75"	3.91"	5.75"
PSRGW14U	14" x 6"	13.5"	15.75"	5.91"	7.75"
PSRGW14X	14" x 8"	13.5"	15.75"	7.91"	9.75"
PSRGW1410	14" x 10"	13.5"	15.75"	9.91"	11.75"
PSRGW1412	14" x 12"	13.5"	15.75"	11.91"	13.75"
PSRGW1414	14" x 14"	13.5"	15.75"	13.91"	15.75"
PSRGW1416	14" x 16"	13.5"	15.75"	15.91"	17.75"
PSRGW1420	14" x 20"	13.5"	15.75"	19.91"	21.75"
PSRGW1424	14" x 24"	13.5"	15.75"	23.91"	25.75"
PSRGW1425	14" x 25"	13.5"	15.75"	24.91"	26.75"
PSRGW1430	14" x 30"	13.5"	15.75"	29.91"	31.75"
PSRGW16U	16" x 6"	15.5"	17.75"	5.91"	7.75"
PSRGW16X	16" x 8"	15.5"	17.75"	7.91"	9.75"
PSRGW1610	16" x 10"	15.5"	17.75"	9.91"	11.75"
PSRGW1612	16" x 12"	15.5"	17.75"	11.91"	13.75"
PSRGW1616	16" x 16"	15.5"	17.75"	15.91"	17.75"
PSRGW1620	16" x 20"	15.5"	17.75"	19.91"	21.75"
PSRGW1624	16" x 24"	15.5"	17.75"	23.91"	25.75"
PSRGW1625	16" x 25"	15.5"	17.75"	24.91"	26.75"
PSRGW18P	18" x 4"	17.5"	19.75"	3.91"	5.75"

SKU	Size	A	B	C	D
PSRGW18U	18" x 6"	17.5"	19.75"	7.91"	5.75"
PSRGW18X	18" x 8"	17.5"	19.75"	7.91"	9.75"
PSRGW1812	18" x 12"	17.5"	19.75"	11.91"	13.75"
PSRGW1818	18" x 18"	17.5"	19.75"	17.91"	19.75"
PSRGW1824	18" x 24"	17.5"	19.75"	23.91"	25.75"
PSRGW1830	18" x 30"	17.5"	19.75"	29.91"	31.75"
PSRGW20U	20" x 6"	19.5"	21.75"	5.91"	7.75"
PSRGW20X	20" x 8"	19.5"	21.75"	7.91"	9.75"
PSRGW2010	20" x 10"	19.5"	21.75"	9.91"	11.75"
PSRGW2012	20" x 12"	19.5"	21.75"	11.91"	13.75"
PSRGW2014	20" x 14"	19.5"	21.75"	13.91"	15.75"
PSRGW2016	20" x 16"	19.5"	21.75"	15.91"	17.75"
PSRGW2020	20" x 20"	19.5"	21.75"	19.91"	21.75"
PSRGW2024	20" x 24"	19.5"	21.75"	23.91"	25.75"
PSRGW2025	20" x 25"	19.5"	21.75"	24.91"	26.75"
PSRGW2030	20" x 30"	19.5"	21.75"	29.91"	31.75"
PSRGW24U	24" x 6"	23.5"	25.75"	5.91"	7.75"
PSRGW24X	24" x 8"	23.5"	25.75"	7.91"	9.75"
PSRGW2410	24" x 10"	23.5"	25.75"	9.91"	11.75"
PSRGW2412	24" x 12"	23.5"	25.75"	11.91"	13.75"
PSRGW2414	24" x 14"	23.5"	25.75"	13.91"	15.75"
PSRGW2416	24" x 16"	23.5"	25.75"	15.91"	17.75"
PSRGW2418	24" x 18"	23.5"	25.75"	17.91"	19.75"
PSRGW2420	24" x 20"	23.5"	25.75"	19.91"	21.75"
PSRGW2424	24" x 24"	23.5"	25.75"	23.91"	25.75"
PSRGW2430	24" x 30"	23.5"	25.75"	29.91"	31.75"
PSRGW2516	25" x 16"	24.5"	26.75"	15.91"	17.75"
PSRGW2520	25" x 20"	24.5"	26.75"	19.91"	21.75"
PSRGW30U	30" x 6"	29.5"	31.75"	5.91"	7.75"
PSRGW30X	30" x 8"	29.5"	31.75"	7.91"	9.75"
PSRGW3010	30" x 10"	29.5"	31.75"	9.91"	11.75"
PSRGW3012	30" x 12"	29.5"	31.75"	11.91"	13.75"
PSRGW3014	30" x 14"	29.5"	31.75"	13.91"	15.75"
PSRGW3016	30" x 16"	29.5"	31.75"	15.91"	17.75"
PSRGW3018	30" x 18"	29.5"	31.75"	17.91"	19.75"
PSRGW3020	30" x 20"	29.5"	31.75"	19.91"	21.75"
PSRGW3024	30" x 24"	29.5"	31.75"	23.91"	25.75"
PSRGW3030	30" x 30"	29.5"	31.75"	29.91"	31.75"
PSRGW3610	36" x 10"	35.5"	37.75"	9.91"	11.75"
PSRGW3612	36" x 12"	35.5"	37.75"	11.91"	13.75"
PSRGW3614	36" x 14"	35.5"	37.75"	13.91"	15.75"
PSRGW3624	36" x 24"	35.5"	37.75"	23.91"	25.75"

Horizontal dimension listed first

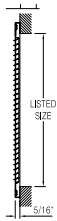
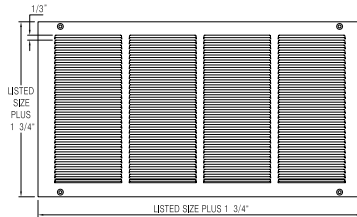

Stamped Steel Return Grilles, 1/3" Fin, 5/16" Turnback



- All-steel construction
- 1/3" spaced fins at 20°
- 5/16" margin turnback
- Screws included
- Color/Finish: White

See P. 88 for performance data

SKU	Size	A	B	C	D	SKU	Size	A	B	C	D
PSRG3WUU	6" x 6"	5.5"	7.75"	5.91"	7.75"	PSRG3W1818	18" x 18"	17.5"	19.75"	17.91"	19.75"
PSRG3WXX	8" x 8"	7.5"	9.75"	7.91"	9.75"	PSRG3W20U	20" x 6"	19.5"	21.75"	5.91"	7.75"
PSRG3W10P	10" x 4"	9.5"	5.75"	3.91"	5.75"	PSRG3W20X	20" x 8"	19.5"	21.75"	7.91"	9.75"
PSRG3W10U	10" x 6"	9.5"	11.75"	5.91"	7.75"	PSRG3W2010	20" x 10"	19.5"	21.75"	9.91"	11.75"
PSRG3W1010	10" x 10"	9.5"	11.75"	9.91"	11.75"	PSRG3W2012	20" x 12"	19.5"	21.75"	11.91"	13.75"
PSRG3W1020	10" x 20"	9.5"	11.75"	19.91"	21.75"	PSRG3W2014	20" x 14"	19.5"	21.75"	13.91"	15.75"
PSRG3W1024	10" x 24"	9.5"	11.75"	23.91"	25.75"	PSRG3W2016	20" x 16"	19.5"	21.75"	15.91"	17.75"
PSRG3W12P	12" x 4"	11.5"	13.75"	3.91"	5.75"	PSRG3W2018	20" x 18"	19.5"	21.75"	17.91"	19.75"
PSRG3W12U	12" x 6"	11.5"	13.75"	5.91"	7.75"	PSRG3W2020	20" x 20"	19.5"	21.75"	19.91"	21.75"
PSRG3W12X	12" x 8"	11.5"	13.75"	7.91"	9.75"	PSRG3W2024	20" x 24"	19.5"	21.75"	23.91"	25.75"
PSRG3W1210	12" x 10"	11.5"	13.75"	9.91"	11.75"	PSRG3W24U	24" x 6"	23.5"	25.75"	5.91"	7.75"
PSRG3W1212	12" x 12"	11.5"	13.75"	11.91"	13.75"	PSRG3W24X	24" x 8"	23.5"	25.75"	7.91"	9.75"
PSRG3W1224	12" x 24"	11.5"	13.75"	23.91"	25.75"	PSRG3W2410	24" x 10"	23.5"	25.75"	9.91"	11.75"
PSRG3W14U	14" x 6"	13.5"	15.75"	5.91"	7.75"	PSRG3W2412	24" x 12"	23.5"	25.75"	11.91"	13.75"
PSRG3W14X	14" x 8"	13.5"	15.75"	7.91"	9.75"	PSRG3W2414	24" x 14"	23.5"	25.75"	13.91"	15.75"
PSRG3W1410	14" x 10"	13.5"	15.75"	9.91"	11.75"	PSRG3W2416	24" x 16"	23.5"	25.75"	15.91"	17.75"
PSRG3W1414	14" x 14"	13.5"	15.75"	13.91"	15.75"	PSRG3W2420	24" x 20"	23.5"	25.75"	19.91"	21.75"
PSRG3W1420	14" x 20"	13.5"	15.75"	19.91"	21.75"	PSRG3W2424	24" x 24"	23.5"	25.75"	23.91"	25.75"
PSRG3W1424	14" x 24"	13.5"	15.75"	23.91"	25.75"	PSRG3W2430	24" x 30"	23.5"	25.75"	29.91"	31.75"
PSRG3W16X	16" x 8"	15.5"	17.75"	7.91"	9.75"	PSRG3W30U	30" x 6"	29.5"	31.75"	5.91"	7.75"
PSRG3W1610	16" x 10"	15.5"	17.75"	9.91"	11.75"	PSRG3W30X	30" x 8"	29.5"	31.75"	7.91"	9.75"
PSRG3W1616	16" x 16"	15.5"	17.75"	15.91"	17.75"	PSRG3W3010	30" x 10"	29.5"	31.75"	9.91"	11.75"
PSRG3W1620	16" x 20"	15.5"	17.75"	19.91"	21.75"	PSRG3W3012	30" x 12"	29.5"	31.75"	11.91"	13.75"
PSRG3W1624	16" x 24"	15.5"	17.75"	23.91"	25.75"	PSRG3W3014	30" x 14"	29.5"	31.75"	13.91"	15.75"
PSRG3W18X	18" x 8"	17.5"	19.75"	7.91"	9.75"	PSRG3W36X	36" x 8"	35.5"	37.75"	7.91"	9.75"
PSRG3W1812	18" x 12"	17.5"	19.75"	11.91"	13.75"						

Horizontal dimension listed first



P. 69

Large Screen Thermostats

- Dual-Powered: Hardwired or battery
- 2" screen with bright blue backlight
- Non-volatile memory retains user settings
- Filter check monitor
- Adaptive recovery mode
- Adjustable temperature differential(s)
- Meets California Title 24 Guidelines

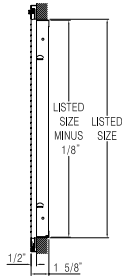
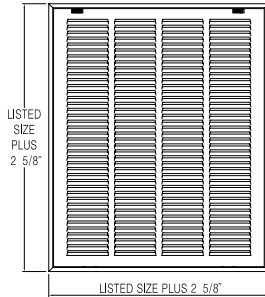

Stamped Steel Return Air Filter Grilles



- All-steel welded construction
- 1/2" spaced fins at 40°
- Removable face with concealed latches and hinges for easy installation and cleaning
- Uses standard 1" thick disposable filters (not included)
- Color/Finish: White

See P. 85-87 for performance data

SKU	Size	A	B	C	D	SKU	Size	A	B	C	D
PSFGW10U	10" x 6"	12.57"	8.57"	5.94"	9.94"	PSFGW2020	20" x 20"	22.57"	22.57"	19.94"	19.94"
PSFGW1010	10" x 10"	12.57"	12.57"	9.94"	9.94"	PSFGW2024	20" x 24"	22.57"	26.57"	23.94"	19.94"
PSFGW1020	10" x 20"	12.57"	22.57"	19.94"	9.94"	PSFGW2025	20" x 25"	22.57"	27.57"	24.94"	19.94"
PSFGW12U	12" x 6"	14.57"	8.57"	5.94"	11.94"	PSFGW2030	20" x 30"	22.57"	32.57"	29.94"	19.94"
PSFGW1212	12" x 12"	14.57"	14.57"	11.94"	11.94"	PSFGW2040	20" x 40"	22.57"	42.57"	39.94"	19.94"
PSFGW1220	12" x 20"	14.57"	22.57"	19.94"	11.94"	PSFGW2222	22" x 22"	24.57"	24.57"	21.94"	21.94"
PSFGW1224	12" x 24"	14.57"	26.57"	23.94"	11.94"	PSFGW24X	24" x 8"	26.57"	10.57"	7.94"	23.94"
PSFGW1230	12" x 30"	14.57"	32.57"	29.94"	11.94"	PSFGW2410	24" x 10"	26.57"	12.57"	9.94"	23.94"
PSFGW1236	12" x 36"	14.57"	38.57"	35.94"	11.94"	PSFGW2412	24" x 12"	26.57"	14.57"	11.94"	23.94"
PSFGW14X	14" x 8"	16.57"	10.57"	7.94"	13.94"	PSFGW2414	24" x 14"	26.57"	16.57"	13.94"	23.94"
PSFGW1410	14" x 10"	16.57"	12.57"	9.94"	13.94"	PSFGW2416	24" x 16"	26.57"	18.57"	15.94"	23.94"
PSFGW1412	14" x 12"	16.57"	14.57"	11.94"	13.94"	PSFGW2418	24" x 18"	26.57"	20.57"	17.94"	23.94"
PSFGW1414	14" x 14"	16.57"	16.57"	13.94"	13.94"	PSFGW2420	24" x 20"	26.57"	22.57"	19.94"	23.94"
PSFGW1420	14" x 20"	16.57"	22.57"	19.94"	13.94"	PSFGW2424	24" x 24"	26.57"	26.57"	23.94"	23.94"
PSFGW1424	14" x 24"	16.57"	26.57"	23.94"	13.94"	PSFGW2430	24" x 30"	26.57"	32.57"	29.94"	23.94"
PSFGW1425	14" x 25"	16.57"	27.57"	24.94"	13.94"	PSFGW2436	24" x 36"	26.57"	38.57"	35.94"	23.94"
PSFGW1430	14" x 30"	16.57"	32.57"	29.94"	13.94"	PSFGW2514	25" x 14"	27.57"	16.57"	13.94"	24.94"
PSFGW1612	16" x 12"	18.57"	14.57"	11.94"	15.94"	PSFGW2516	25" x 16"	27.57"	18.57"	15.94"	24.94"
PSFGW1616	16" x 16"	18.57"	18.57"	15.94"	15.94"	PSFGW2520	25" x 20"	27.57"	22.57"	19.94"	24.94"
PSFGW1620	16" x 20"	18.57"	22.57"	19.94"	15.94"	PSFGW2525	25" x 25"	27.57"	27.57"	24.94"	24.94"
PSFGW1624	16" x 24"	18.57"	26.57"	23.94"	15.94"	PSFGW2532	25" x 32"	27.57"	34.57"	31.94"	24.94"
PSFGW1625	16" x 25"	18.57"	27.57"	24.94"	15.94"	PSFGW30X	30" x 8"	32.57"	10.57"	7.94"	29.94"
PSFGW1630	16" x 30"	18.57"	32.57"	29.94"	15.94"	PSFGW3010	30" x 10"	32.57"	12.57"	9.94"	29.94"
PSFGW18X	18" x 8"	20.57"	10.57"	7.94"	17.94"	PSFGW3012	30" x 12"	32.57"	14.57"	11.94"	29.94"
PSFGW1812	18" x 12"	20.57"	14.57"	11.94"	17.94"	PSFGW3014	30" x 14"	32.57"	16.57"	13.94"	29.94"
PSFGW1818	18" x 18"	20.57"	20.57"	17.94"	17.94"	PSFGW3016	30" x 16"	32.57"	18.57"	15.94"	29.94"
PSFGW1824	18" x 24"	20.57"	26.57"	23.94"	17.94"	PSFGW3018	30" x 18"	32.57"	20.57"	17.94"	29.94"
PSFGW1830	18" x 30"	20.57"	32.57"	29.94"	17.94"	PSFGW3020	30" x 20"	32.57"	22.57"	19.94"	29.94"
PSFGW20X	20" x 8"	22.57"	10.57"	7.94"	19.94"	PSFGW3024	30" x 24"	32.57"	26.57"	23.94"	29.94"
PSFGW2010	20" x 10"	22.57"	12.57"	9.94"	19.94"	PSFGW3025	30" x 25"	32.57"	27.57"	24.94"	29.94"
PSFGW2012	20" x 12"	22.57"	14.57"	11.94"	19.94"	PSFGW3030	30" x 30"	32.57"	26.57"	29.94"	29.94"
PSFGW2014	20" x 14"	22.57"	16.57"	13.94"	19.94"	PSFGW3225	32" x 25"	34.57"	27.57"	27.94"	31.94"
PSFGW2016	20" x 16"	22.57"	18.57"	15.94"	19.94"	PSFGW4020	40" x 20"	42.57"	22.57"	19.94"	34.94"

Horizontal dimension listed first

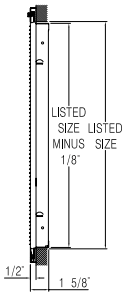
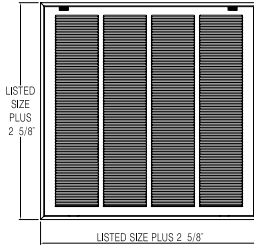

Stamped Steel Return Air Filter Grilles, 1/3" Fin



- All-steel construction
- 1/3" spaced fins set at 20°
- Effectively conceals filter
- Uses standard 1" thick disposable filters (not included)
- Removable face for easy installation and cleaning
- Equipped with adjustable filter retainers
- Color/Finish: White

See P. 89 for performance data

SKU	Size	A	B	C	D
PSFG3W1212	12" x 12"	14.57"	14.57"	11.94"	11.94"
PSFG3W14U	14" x 6"	16.57"	8.57"	5.94"	13.94"
PSFG3W1414	14" x 14"	16.57"	16.57"	13.94"	13.94"
PSFG3W1420	14" x 20"	16.57"	22.57"	19.94"	13.94"
PSFG3W1424	14" x 24"	16.57"	26.57"	23.94"	13.94"
PSFG3W1425	14" x 25"	16.57"	27.57"	24.94"	13.94"
PSFG3W1616	16" x 16"	18.57"	18.57"	15.94"	15.94"
PSFG3W1620	16" x 20"	18.57"	22.57"	19.94"	15.94"
PSFG3W1625	16" x 25"	18.57"	22.57"	19.94"	15.94"
PSFG3W1818	18" x 18"	20.57"	20.57"	17.94"	17.94"
PSFG3W2012	20" x 12"	19.50"	22.57"	11.91"	14.57"
PSFG3W2014	20" x 14"	22.57"	16.57"	13.94"	19.94"
PSFG3W2016	20" x 16"	22.57"	18.57"	15.94"	19.94"
PSFG3W2020	20" x 20"	22.57"	22.57"	19.94"	19.94"
PSFG3W2025	20" x 25"	22.57"	27.57"	24.94"	19.94"
PSFG3W2412	24" x 12"	26.57"	14.57"	11.94"	23.94"
PSFG3W2424	24" x 24"	26.57"	26.57"	23.94"	23.94"
PSFG3W2520	25" x 20"	27.57"	22.57"	19.94"	24.94"
PSFG3W3014	30" x 14"	32.57"	16.57"	13.94"	29.94"

Horizontal dimension listed first



Take advantage of everything PROSELECT has to offer:

- » Access to thousands of additional SKUs
- » Special Orders
- » Competitive Pricing
- » Regional Quotation Centers

Visit Proselectproducts.com to find the nearest sales associate



Fixed Bar Filter Grilles



- All-steel construction
- 3/4" spaced fins set at 35°
- Flush, removable face, concealed latches and hinges
- Uses 1" thick disposable filters (not included)
- Color/Finish: White

See P. 90 for performance data

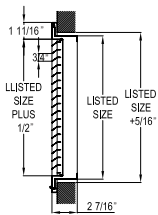
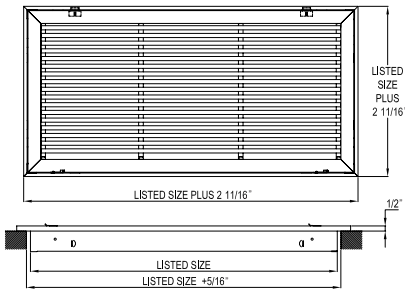

SKU	Size	A	B	C	D
PSFBFG2W1010	10" x 10"	12.586"	12.586"	9.889"	9.889"
PSFBFG2W1212	12" x 12"	14.586"	14.586"	11.889"	11.889"
PSFBFG2W1414	14" x 14"	16.586"	16.586"	13.889"	13.889"
PSFBFG2W1420	14" x 20"	16.586"	22.586"	13.889"	19.889"
PSFBFG2W1424	14" x 24"	16.586"	26.586"	13.889"	23.889"
PSFBFG2W1425	14" x 25"	16.586"	27.586"	13.889"	24.889"
PSFBFG2W1430	14" x 30"	16.586"	32.586"	13.889"	29.889"
PSFBFG2W1616	16" x 16"	18.586"	18.586"	15.889"	15.889"
PSFBFG2W1625	16" x 25"	18.586"	27.586"	15.889"	24.889"
PSFBFG2W1816	18" x 16"	20.586"	18.586"	17.889"	15.889"
PSFBFG2W1818	18" x 18"	20.586"	20.586"	17.889"	17.889"
PSFBFG2W2010	20" x 10"	22.586"	12.586"	19.889"	9.889"
PSFBFG2W2012	20" x 12"	22.586"	14.586"	19.889"	11.889"
PSFBFG2W2014	20" x 14"	22.586"	16.586"	19.889"	13.889"
PSFBFG2W2016	20" x 16"	22.586"	18.586"	19.889"	15.889"
PSFBFG2W2020	20" x 20"	22.586"	22.586"	19.889"	19.889"
PSFBFG2W2025	20" x 25"	22.586"	27.586"	19.889"	24.889"
PSFBFG2W2030	20" x 30"	22.586"	32.586"	19.889"	29.889"
PSFBFG2W2410	24" x 10"	26.586"	12.586"	23.889"	9.889"
PSFBFG2W2412	24" x 12"	26.586"	14.586"	23.889"	11.889"
PSFBFG2W2414	24" x 14"	26.586"	16.586"	23.889"	13.889"
PSFBFG2W2416	24" x 16"	26.586"	18.586"	23.889"	15.889"
PSFBFG2W2420	24" x 20"	26.586"	22.586"	23.889"	19.889"
PSFBFG2W2424	24" x 24"	26.586"	26.586"	23.889"	23.889"
PSFBFG2W2512	25" x 12"	27.586"	14.586"	24.889"	11.889"
PSFBFG2W2514	25" x 14"	27.586"	16.586"	24.889"	13.889"
PSFBFG2W2516	25" x 16"	27.586"	18.586"	24.889"	15.889"
PSFBFG2W2520	25" x 20"	27.586"	22.586"	24.889"	19.889"
PSFBFG2W3010	30" x 10"	32.586"	12.586"	29.889"	9.889"
PSFBFG2W3012	30" x 12"	32.586"	14.586"	29.889"	11.889"
PSFBFG2W3014	30" x 14"	32.586"	16.586"	29.889"	13.889"
PSFBFG2W3016	30" x 16"	32.586"	18.589"	29.889"	15.889"
PSFBFG2W3018	30" x 18"	32.586"	20.586"	29.889"	17.889"
PSFBFG2W3020	30" x 20"	32.586"	22.586"	29.889"	19.889"
PSFBFG2W3024	30" x 24"	32.586"	26.586"	29.889"	23.889"
PSFBFG2W3614	36" x 14"	38.586"	16.586"	35.889"	13.889"
PSFBFG2W4020	40" x 20"	42.586"	22.586"	39.889"	19.889"

Horizontal dimension listed first

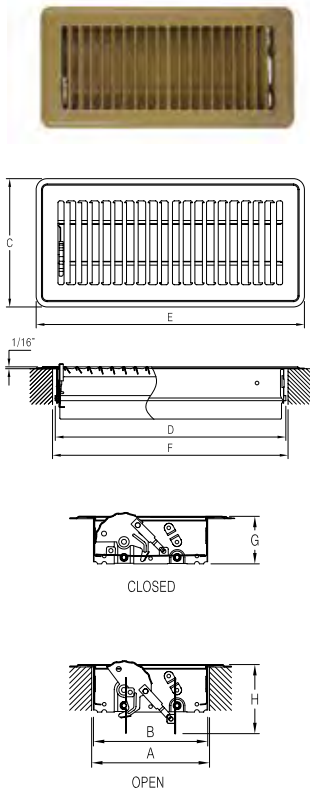

Stamped Steel Floor Diffusers



- All-steel welded construction
- Heavy gauge steel construction for floor use
- Multi-angled fin setting
- Foot-operated damper

See P. 90 for performance data

SKU	Size	Color/Finish	A	B	C	D
PSFDBK10	2" x 10"	Brown	11.5"	3.75"	9.86"	2.126"
PSFDWK10	2" x 10"	White	11.5"	3.75"	9.86"	2.126"
PSFDBK12	2" x 12"	Brown	13.5"	3.75"	11.86"	2.126"
PSFDWK12	2" x 12"	White	13.5"	3.75"	11.86"	2.126"
PSFDBK14	2" x 14"	Brown	15.5"	3.75"	13.86"	2.126"
PSFDWK14	2" x 14"	White	15.5"	3.75"	13.86"	2.126"
PSFDBPX	4" x 8"	Brown	9.5"	5.5"	7.86"	3.937"
PSFDWPX	4" x 8"	White	9.5"	5.5"	7.86"	3.937"
PSFDBP10	4" x 10"	Brown	11.5"	5.5"	9.86"	3.937"
PSFDWP10	4" x 10"	White	11.5"	5.5"	9.86"	3.937"
PSFDBP12	4" x 12"	Brown	13.5"	5.5"	11.86"	3.937"
PSFDWP12	4" x 12"	White	13.5"	5.5"	11.86"	3.937"
PSFDBP14	4" x 14"	Brown	15.5"	5.5"	13.86"	3.937"
PSFDWP14	4" x 14"	White	15.5"	5.5"	13.86"	3.937"
PSFDBU10	6" x 10"	Brown	11.5"	7.25"	9.86"	5.75"
PSFDWU10	6" x 10"	White	11.5"	7.25"	9.86"	5.75"
PSFDBU12	6" x 12"	Brown	15.5"	7.25"	13.86"	5.75"
PSFDWU12	6" x 12"	White	13.5"	7.25"	11.86"	5.75"
PSFDBU14	6" x 14"	Brown	13.5"	7.25"	11.86"	5.75"
PSFDWU14	6" x 14"	White	15.5"	7.25"	13.86"	5.75"
PSFDBX14	8" x 14"	Brown	15.5"	9.00"	13.86"	7.75"
PSFDWX14	8" x 14"	White	15.5"	9.00"	13.86"	7.75"

Horizontal dimension listed first

SKU



SKU by Ferguson is the barcode scanner app that cuts the time you spend on preparing orders by turning your mobile device's camera into a barcode scanner. Use it for the products you stock in your warehouse or on your truck. Just scan any Ferguson barcode and enter the quantity of the items you need, or key in product codes.

- 1 Tap **Start Scanning** and point your phone's camera to the barcode you wish to scan.
- 2 Edit the quantity and tap **Add SKU** to add it to the list. Manually add SKU if the barcode will not scan. Enter the part number in the **Enter Your SKU** field. Adjust the quantity and tap **Add SKU**.
- 3 Tap the **Menu** button (in the top left of the screen) when you are finished with your list. Tap **Send List** to prepare your list to be emailed.

- 4 Tap **Launch Email** to open an email on your phone and send your list. There are two ways to place an order:

1. FERGUSON.COM:

- Email to yourself or your purchasing manager and save the excel file to your computer. On the **My Lists** page at FERGUSON.COM, click **"Copy/Paste Products."** In the window that appears, copy and paste the items from your file into the text box and click **"Add."** Move individual items or your entire list to the cart to place your order.

2. Send to your Ferguson Sales Associate:

- Email your associate directly from the SKU App.
- Add any important notes to the email you send over.

Download the App today on the Apple or Android App Store by searching Ferguson SKU

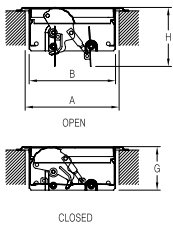
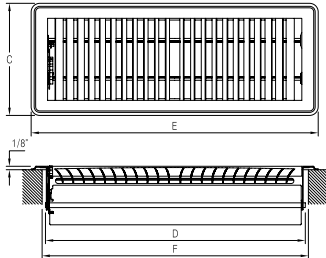

Floor Diffusers Deluxe



- Deluxe
- All-steel construction
- Heavy gauge steel construction for floor use
- Made for high traffic areas
- Multi-angle fin settings
- Easy foot-operated damper

See P. 91 for performance data

SKU	Size	Color/Finish	A	B	C	D	E	F
PSDFDBK10	2" x 10"	Brown	11.125"	3.375"	9.881"	2.18"	2"	9.625"
PSDFDBK12	2" x 12"	Brown	13.125"	3.375"	11.881"	2.18"	2"	9.625"
PSDFDBK14	2" x 14"	Brown	15.125"	3.375"	13.881"	2.18"	2"	13.625"
PSDFDBP10	4" x 10"	Brown	11.125"	5.125"	9.881"	3.95"	5.375"	9.625"
PSDFDBP12	4" x 12"	Brown	13.125"	5.125"	11.881"	3.95"	3.75"	11.625"
PSDFDBP14	4" x 14"	Brown	15.125"	5.125"	13.881"	3.95"	3.75"	13.625"
PSDFDBU10	6" x 10"	Brown	11.5"	7.25"	9.881"	5.63"	5.375"	9.625"
PSDFDWU10	6" x 10"	White	11.5"	7.25"	9.881"	5.63"	5.375"	9.625"
PSDFDBU12	6" x 12"	Brown	13.5"	7.25"	11.881"	5.63"	5.375"	11.625"
PSDFDBU14	6" x 14"	Brown	15.5"	7.25"	13.881"	5.63"	5.375"	13.625"
PSDFDWU14	6" x 14"	White	15.5"	7.25"	13.881"	5.63"	5.375"	13.625"

Horizontal dimension listed first

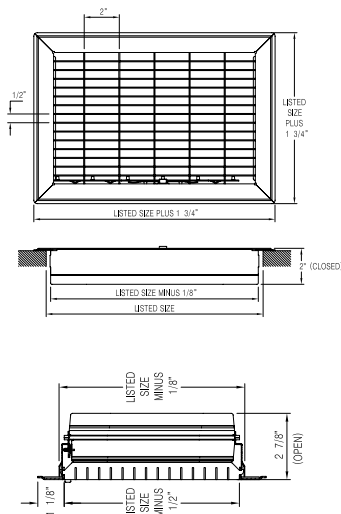

Floor Registers



- All-steel construction
- Rigid
- Firm, smooth surface
- Average 75% free area
- Toe-operated damper control

See P. 91 for performance data

SKU	Size	Color/Finish	A	B	C	D
PSFRDBPX	4" x 8"	Brown	9.73"	5.73"	7.89"	3.93"
PSFRDWP10	4" x 10"	White	11.73"	5.73"	9.89"	3.93"
PSFRDBP12	4" x 12"	Brown	13.73"	5.73"	11.89"	3.93"
PSFRDBP14	4" x 14"	Brown	15.73"	5.73"	13.89"	3.93"
PSFRDBUX	6" x 8"	Brown	9.73"	7.73"	7.89"	5.93"
PSFRDWU10	6" x 10"	White	11.73"	7.73"	9.89"	5.93"
PSFRDBU12	6" x 12"	Brown	13.75"	7.73"	11.89"	5.93"
PSFRDBU14	6" x 14"	Brown	15.73"	7.73"	13.89"	5.93"
PSFRDBXX	8" x 8"	Brown	9.73"	9.73"	7.89"	7.93"
PSFRDBX12	8" x 12"	Brown	13.75"	9.73"	11.89"	7.93"
PSFRDBX14	8" x 14"	Brown	15.73"	9.73"	13.89"	7.93"
PSFRDB10P	10" x 4"	Brown	5.73"	11.73"	5.89"	9.93"
PSFRDB10U	10" x 6"	Brown	6.73"	11.73"	7.89"	9.93"

Horizontal dimension listed first

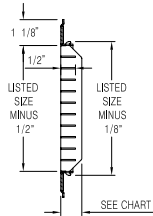
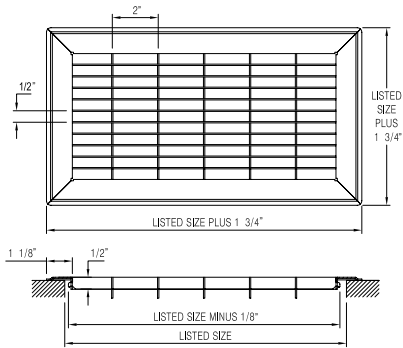

HT	MAXIMUM DEPTH
4-14	3/4
16-24	1-7/16

Floor Return Air Grilles



- All-steel construction
- Rigid
- Firm, smooth surface
- Average 75% free area
- Color/Finish: Brown

See P. 92 for performance data

SKU	Size	A	B	C	D	E
PSFRGBP10	4" x 10"	5.75"	11.75"	3.82"	9.82"	0.73"
PSFRGBP12	4" x 12"	5.75"	13.75"	3.82"	11.82"	0.73"
PSFRGBP14	4" x 14"	5.75"	15.75"	3.82"	13.82"	0.73"
PSFRGBP30	4" x 30"	5.75"	31.75"	3.82"	29.82"	0.73"
PSFRGBU10	6" x 10"	7.75"	11.75"	5.82"	9.82"	0.73"
PSFRGBU12	6" x 12"	7.75"	13.75"	5.82"	11.82"	0.73"
PSFRGBU14	6" x 14"	7.75"	15.75"	5.82"	13.82"	0.73"
PSFRGBU18	6" x 18"	7.75"	19.75"	5.82"	17.82"	0.73"
PSFRGBU20	6" x 20"	7.75"	21.75"	5.82"	19.82"	0.73"
PSFRGBU24	6" x 24"	7.75"	25.75"	5.82"	23.82"	0.73"
PSFRGBU30	6" x 30"	7.75"	31.75"	5.82"	29.82"	0.73"
PSFRGBX10	8" x 10"	9.75"	11.75"	7.82"	9.82"	0.73"
PSFRGBX12	8" x 12"	9.75"	13.75"	7.82"	11.82"	0.73"
PSFRGBX14	8" x 14"	9.75"	15.75"	7.82"	13.82"	0.73"
PSFRGBX16	8" x 16"	9.75"	17.75"	7.82"	15.82"	0.73"
PSFRGBX20	8" x 20"	9.75"	21.75"	7.82"	19.82"	0.73"
PSFRGBX24	8" x 24"	9.75"	25.75"	7.82"	23.82"	0.73"
PSFRGBX30	8" x 30"	9.75"	31.75"	7.82"	29.82"	0.73"
PSFRGB1010	10" x 10"	11.75"	11.75"	9.82"	9.82"	0.73"
PSFRGB1012	10" x 12"	11.75"	13.75"	9.82"	11.82"	0.73"
PSFRGB1014	10" x 14"	11.75"	15.75"	9.82"	13.82"	0.73"
PSFRGB1016	10" x 16"	11.75"	17.75"	9.82"	15.82"	0.73"
PSFRGB1020	10" x 20"	11.75"	21.75"	9.82"	19.82"	0.73"
PSFRGB1024	10" x 24"	11.75"	25.75"	9.82"	23.82"	0.73"
PSFRGB1030	10" x 30"	11.75"	31.75"	9.82"	29.82"	0.73"
PSFRGB1212	12" x 12"	13.75"	13.75"	11.82"	11.82"	0.73"
PSFRGB1214	12" x 14"	13.75"	15.75"	11.82"	13.82"	0.73"
PSFRGB1220	12" x 20"	13.75"	21.75"	11.82"	19.82"	0.73"
PSFRGB1224	12" x 24"	13.75"	25.75"	11.82"	23.82"	0.73"
PSFRGB1230	12" x 30"	13.75"	31.75"	11.82"	29.82"	0.73"
PSFRGB14P	14" x 4"	15.75"	5.75"	13.82"	3.82"	0.73"
PSFRGB1414	14" x 14"	15.75"	15.75"	13.82"	13.82"	0.73"
PSFRGB1420	14" x 20"	15.75"	21.75"	13.82"	19.82"	0.73"
PSFRGB1424	14" x 24"	15.75"	25.75"	13.82"	23.82"	0.73"
PSFRGB1430	14" x 30"	15.75"	31.75"	13.82"	29.82"	0.73"
PSFRGB1616	16" x 16"	17.75"	17.75"	15.82"	15.82"	1.4"
PSFRGB1620	16" x 20"	17.75"	21.75"	15.82"	19.82"	1.4"
PSFRGB1624	16" x 24"	17.75"	25.75"	15.82"	23.82"	1.4"
PSFRGB2020	20" x 20"	21.75"	21.75"	19.82"	19.82"	1.4"
PSFRGB36U	36" x 6"	7.75"	37.75"	5.82"	35.82"	1.4"

Horizontal dimension listed first

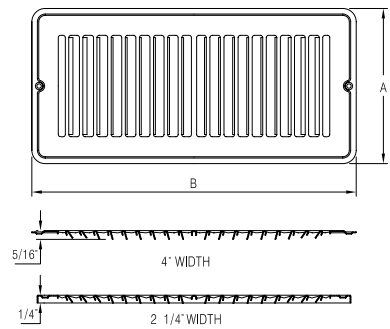

Stamped Steel Toe Space Grilles



- All-steel construction
- Heavy gauge steel construction for floor use
- Multi-angled fin setting

See P. 91 for performance data

SKU	Size	Color/Finish	A	B	C	D
PSTSBK10	2" x 10"	Brown	11.125"	9.625"	2"	3.38"
PSTSWK10	2" x 10"	White	11.125"	9.625"	2"	3.38"
PSTSBK12	2" x 12"	Brown	13.125"	11.625"	2"	3.38"
PSTSWK12	2" x 12"	White	13.125"	11.625"	2"	3.38"
PSTSBK14	2" x 14"	Brown	15.125"	13.625"	2"	3.38"
PSTSWK14	2" x 14"	White	15.125"	13.625"	2"	3.38"
PSTSBP10	4" x 10"	Brown	11.125"	9.625"	4"	5.38"

Horizontal dimension listed first

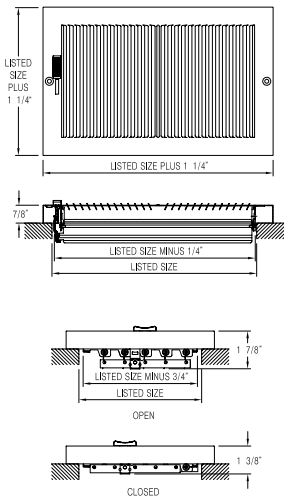

Baseboard Registers, 1/3" Fin



- All-steel construction
- 1/3" spaced fins set at 20°
- 7/8" margin turnback
- 1 5/8" depth when fully opened
- Exceptional free area
- Ideal for shallow duct installations
- Multi-shutter damper
- Color/Finish: White

See P. 91 for performance data

SKU	Size	A	B	C	D
PSBBR783W10U	10" x 6"	11.25"	7.25"	9.76"	5.63"
PSBBR783W14U	14" x 6"	15.25"	7.25"	13.76"	5.63"

Horizontal dimension listed first

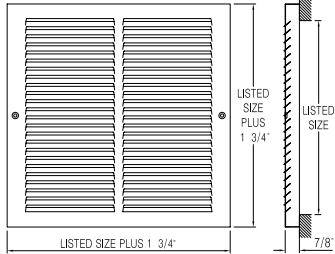

Return Air Grilles, 1/2" Fin, 7/8" Turnback



- One-piece steel construction
- 1/2" spaced fins set at 40°
- 7/8" margin turnback
- Complementary return air grille for 1/2" spaced products
- Color/Finish: White

See P. 93 for performance data

SKU	Size	A	B
PSRG78W14X	14" x 8"	15.75"	9.75"
PSRG78W30X	30" x 8"	31.75"	9.75"

Horizontal dimension listed first

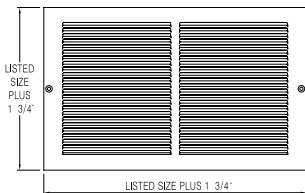

Stamped Steel Baseboard Return Air Grilles, 1/3" Fin, 7/8" Turnback



- All-steel welded construction
- 1/3" spaced fins at 20°
- 7/8" margin turnback
- 1-way air pattern
- Install with fins downward or upward to reduce visibility
- Screws included
- Color/Finish: White

See P. 93 for performance data

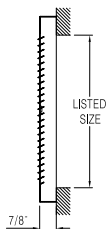

SKU	Size	A	B	C	D
PSRG783W12U	12" x 6"	11.5"	13.75"	5.91"	7.75"
PSRG783W12X	12" x 8"	11.5"	13.75"	7.91"	9.75"
PSRG783W14U	14" x 6"	13.5"	15.75"	5.91"	7.75"
PSRG783W14X	14" x 8"	13.5"	15.75"	7.91"	9.75"
PSRG783W16X	16" x 8"	15.5"	17.75"	7.91"	9.75"
PSRG783W20X	20" x 8"	19.5"	21.75"	7.91"	9.75"
PSRG783W24U	24" x 6"	23.5"	25.75"	5.91"	7.75"
PSRG783W24X	24" x 8"	23.5"	25.75"	7.91"	9.75"
PSRG783W2412	24" x 12"	23.5"	25.75"	11.91"	13.75"
PSRG783W30U	30" x 6"	29.5"	31.75"	5.91"	7.75"
PSRG783W30X	30" x 8"	29.5"	31.75"	7.91"	9.75"
PSRG783W3010	30" x 10"	29.5"	31.75"	9.91"	11.75"
PSRG783W3012	30" x 12"	29.5"	31.75"	11.91"	13.75"
PSRG783W36U	36" x 6"	35.5"	37.75"	5.91"	7.75"
PSRG783W36X	36" x 8"	35.5"	37.75"	7.91"	9.75"

Horizontal dimension listed first

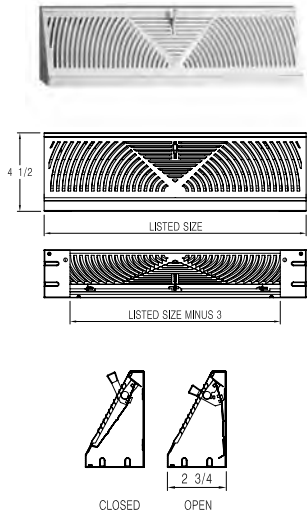

Baseboard Diffusers



- All-steel welded construction
- Lever-operated multi-shutter damper
- Design blankets both wall or window areas

See P. 93 for performance data

SKU	Length	Color/Finish
PSBBDW15	15"	White
PSBBDW18	18"	Brown
PSBBDW18	18"	White

Horizontal dimension listed first

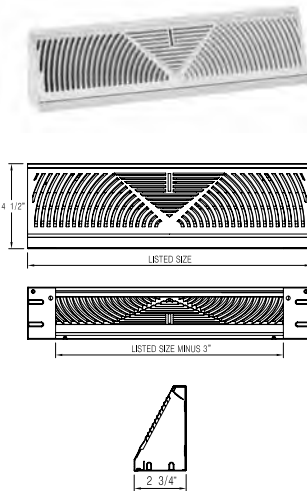

Baseboard Return Grilles



- All-steel construction
- Return air grille for PSBBD
- Length: 18"
- Color/Finish: White

See P. 93 for performance data

SKU
PSBBRW18

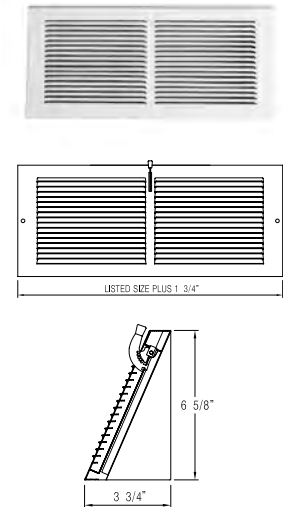

Baseboard Registers with Damper



- All-steel construction
- 1/3" spaced fins set at 20°
- Features positive volume-control damper
- Color/Finish: White

See P. 93 for performance data

SKU	Size	A	B
PSBBRD10U	10" x 6"	11.75"	9.5"
PSBBRD14U	14" x 6"	15.75"	13.5"

Horizontal dimension listed first

Residential Products

Grilles · Diffusers · Dampers

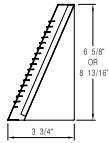
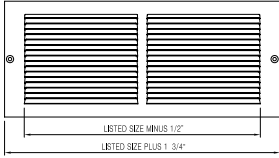

Baseboard Return Grilles, 1/3" Fin



- All-steel construction
- 1/3" spaced fins set at 20°
- Color/Finish: White

See P. 93 for performance data

SKU	Size	A	B
PSBRG3W14U	14" x 6"	15.75"	13.5"
PSBRG3W30U	30" x 6"	31.75"	29.5"

Horizontal dimension listed first

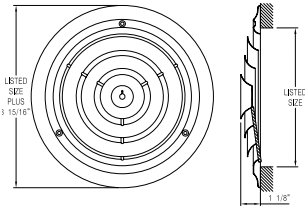

Round Ceiling Diffusers



- All-steel construction
- Concentric rings deflect air stream 360° for maximum performance
- Color/Finish: White

See P. 93 for performance data

SKU	Size	A	B
PSRCDWU	6"	8.58"	.91"
PSRCDWX	8"	10.58"	1.04"
PSRCDW10	10"	13.94"	1.44"
PSRCDW12	12"	15.94"	1.55"
PSRCDW14	14"	19.74"	1.75"

Horizontal dimension listed first

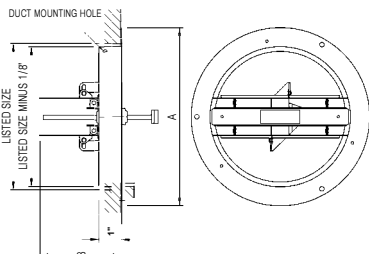
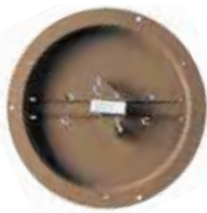

Round Ceiling Dampers



- All-steel construction
- Controls air volume evenly
- Removable knob operator for adjustment from closed to fully open
- Duct size = listed size
- Color/Finish: Brown

SKU	Size	A	B	C
PSRDRU	6"	5.9"	3.4"	7.5"
PSRDRX	8"	7.9"	4.4"	9.5"
PSRDR10	10"	9.9"	5.47"	11"
PSRDR12	12"	11.9"	6.45"	13"
PSRDR14	14"	13.9"	7.45"	15"

Horizontal dimension listed first

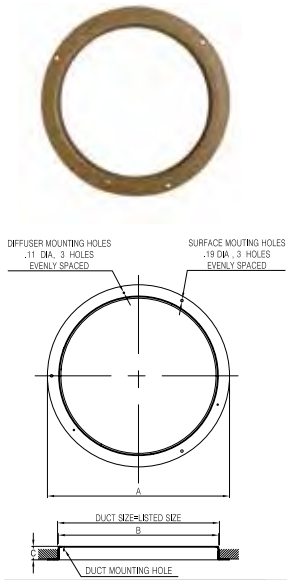

Duct Rings



- All-steel welded construction
- To be used with PSRCD diffuser
- Provides easy attachment of round duct work
- Color/Finish: Brown

SKU	Size	A	B	C
PSDRU	6"	7.5"	5.9"	0.94"
PSDRX	8"	9.5"	7.9"	0.94"
PSDR10	10"	11.5"	9.9"	1"
PSDR12	12"	13.5"	11.9"	1"
PSDR14	14"	15"	13.9"	1"

Horizontal dimension listed first



Aluminum Ceiling Diffusers 3-Way

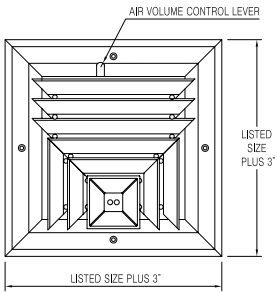

- All-aluminum face construction
- For sidewall or ceiling applications
- Cores flush with margin
- 3-way air diffusion
- Face mount for easy installation
- Opposed blade damper
- Inconspicuous fingertip lever for air volume control
- Color/Finish: White

See P. 101 for performance data

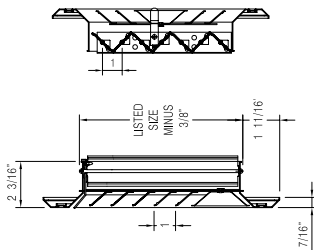

SKU	Size	A	B	C
PSA3WUU	6" x 6"	9"	5.6"	5.26"
PSA3WXX	8" x 8"	11"	7.6"	7.26"
PSA3W1010	10" x 10"	13"	9.6"	9.26"
PSA3W1212	12" x 12"	15"	11.6"	11.26"

Horizontal dimension listed first

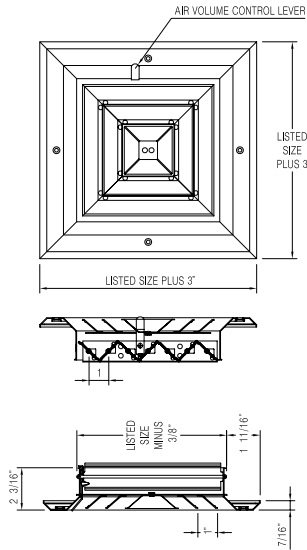

Aluminum Ceiling Diffusers 4-Way



- All-aluminum face construction
- For sidewall or ceiling applications
- Cores flush with margin
- 4-way air diffusion
- Face mount for easy installation
- Opposed blade damper
- Inconspicuous fingertip lever for air volume control
- Color/Finish: White

See P. 101 for performance data

SKU	Size	A	B	C
PSA4WUU	6" x 6"	9"	5.6"	5.26"
PSA4WXX	8" x 8"	11"	7.6"	7.26"
PSA4W1010	10" x 10"	13"	9.6"	9.26"
PSA4W1212	12" x 12"	15"	11.6"	11.26"
PSA4W1414	14" x 14"	17"	13.6"	13.26"

Horizontal dimension listed first

PROSELECT has everything you need to get your HVAC job done.

- Brushes
- Cable Ties
- Condensate Pumps
- Condenser Pads
- Fasteners
- Gloves
- GRDs
- Overflow Switches
- Tapes
- Thermostats

To view all PROSELECT products, visit FERGUSON.COM.



Commercial Products



Pages 39-59



Steel High Velocity T-Bar Diffusers 2-Cone



- Steel construction
- High capacity 2-cone design
- 2" standard inlet collar with turned edge
- 360° uniform air pattern
- Fixed cone design
- Color/Finish: White

See P. 102 for performance data

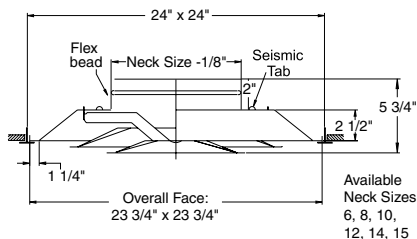

SKU	Neck Size
PSHVDU	6"
PSHVDX	8"
PSHVD10	10"
PSHVD12	12"
PSHVD14	14"

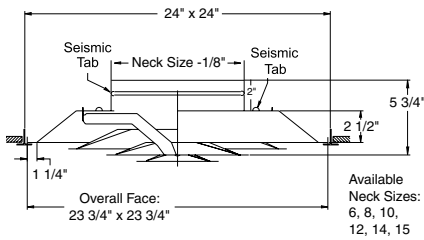

Steel High Velocity T-Bar Diffusers 3-Cone



- Steel construction/ fixed cone design
- High capacity 3-cone design
- 2" standard inlet collar
- 360° uniform air pattern
- Color/Finish: White

See P. 102 for performance data

SKU	Neck Size	Insulated Foil Back – R6	Insulated Foil Back – R6 with Butterfly Damper
PSHVD3U	6"	SKU	SKU
PSHVD3X	8"	PSHVD3IU	PSHVD3IBDU
PSHVD310	10"	PSHVD3IX	PSHVD3IBDX
PSHVD312	12"	PSHVD3110	PSHVD3IBD10
PSHVD314	14"	PSHVD3112	PSHVD3IBD12

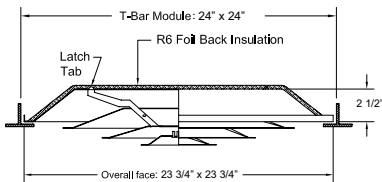

Steel High Velocity T-Bar Diffusers 3-Cone, Insulated, No Neck



- Steel construction
- High capacity 3-cone design
- Size: 24" x 24"
- Quick-release inner assembly
- Includes a foil insulated backpan and accepts 6" to 14" field supplied inlet collars
- Color/Finish: White

See P. 102 for performance data

SKU
PSHVD32424

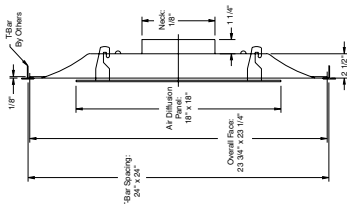

PSSPD12424:

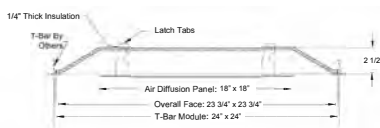

Steel Square Plaque Diffusers for T-Bar Lay-in Ceiling Grids



- Steel construction
- Attractive single panel design blends well with all ceilings
- Removable air diffusion panel
- Uniform 360° radiant air diffusion pattern
- Color/Finish: White

See P. 102 for performance data

SKU	Neck Size
PSSPDU	6"
PSSPDX	8"
PSSPD10	10"
PSSPD12	12"
PSSPD14	14"
PSSPD12424	Insulated, No Neck

Ceiling Diffusers for T-Bar, Expanded Metal Face

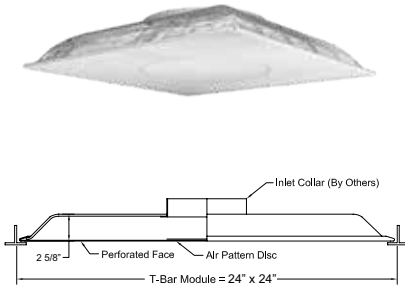

- Size: 24" x 24"
- An economical diffuser with a fiberglass plenum designed to allow field installation of the inlet collar (by others)
- Round target disc for 360° circular pattern on supply
- Face of the diffuser is non-removable with pattern controls
- Provides a 360° tight horizontal circular pattern along the ceiling
- An excellent choice for VAV applications
- Color/Finish: White face with black interior

See P. 102 for performance data

SKU	Type
PSPRDI2424	Return
PSPSDI2424	Supply

Perforated Supply with Target Back

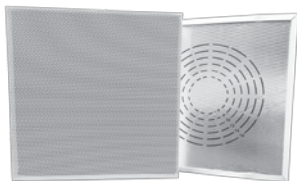

- Size: 24" x 24"
- An economical diffuser with a fiberglass plenum designed to allow field installation of the inlet collar (by others)
- Round target disc for 360° circular pattern on supply
- An excellent choice for VAV applications
- Color/Finish: White face with black interior

See P. 103 for performance data

SKU	Type
PSPFBR	Return
PSPFBS	Supply

Ceiling Diffusers for T-Bar, Perforated Shallow Back



- Steel construction
- Four air pattern controllers pivot 360° on inside of face to achieve 1, 2, 3, or 4-way air flow
- Face is hinged for quick access to pattern controllers
- Color/Finish: White

See P. 103 for performance data

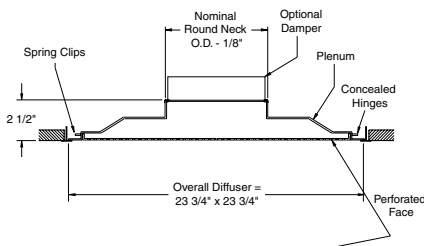

SKU	Neck Size
PSPBSSTU	6"
PSPBSSTX	8"
PSPBSST10	10"
PSPBSST12	12"
PSPBSST14*	14"

*Denotes Non-Stock Item

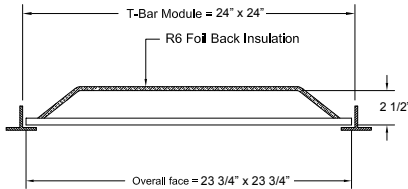

Ceiling Diffusers for T-Bar, Perforated with Insulated Back



- Steel construction
- Size: 24" x 24"
- Insulated
- Four air pattern controllers pivot 360° on inside of face to achieve 1, 2, 3, or 4-way air flow
- Face is hinged for quick access to pattern controllers
- Fiberglass backpan accepts inlet collars by others
- Color/Finish: White

See P. 104 for performance data

SKU

PSPSI

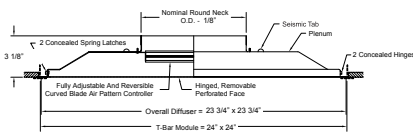
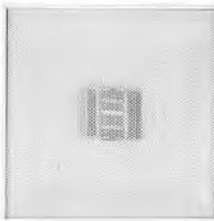

Perforated Supply



- Steel construction with seismic/earthquake tabs
- Perforated supply
- Non-insulated
- Curved blade pattern controllers mounted in the neck of the diffuser
- Pattern controllers are adjustable from a horizontal to vertical discharge pattern
- The hinged, fully removable face allows access to the pattern controllers
- T-Bar lay-in can be used in surface mounting applications by adding optional T-Bar plaster frame PSSMF2424
- Matching returns available: PSCBRST (round neck)
- An excellent choice for VAV applications
- Color/Finish: White

See P. 103 for performance data

SKU

Neck Size

PSPCBSSTU

6"

PSPCBSSTX

8"

PSPCBSST10

10"

PSPCBSST12

12"

PSPCBSST14

14"

PSPCBSST16

16"

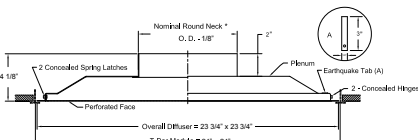

* Available Standard Nominal Neck Size:
6, 8, 10, 12, 14, 16 and 18 For 24 x 24 Models PS PCB RST

Perforated Returns



- Steel construction
- Face is hinged for quick access
- Color/Finish: White

See P. 103 for performance data

SKU

Neck Size

PSPCBRSTU

6"

PSPCBRSTX

8"

PSPCBRST10

10"

PSPCBRST12

12"

PSPCBRST14

14"

PSPCBRST16

16"

PSPCBRST18

18"

PSPCBRST20*

20"

*Denotes Non-Stock Item

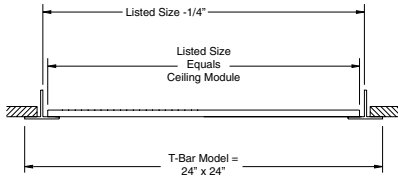

Return Air Grilles for T-Bar, Perforated



- Steel construction
- For T-Bar lay-in
- Designed as a non-ducted return
- Perforated face has 3/16" diameter holes on 1/4" centers
- Color/Finish: White

See P. 103 for performance data

SKU	Size
PSPRF2412	24" x 12"
PSPRF	24" x 24"

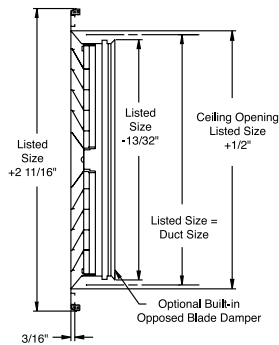

Aluminum Louver Face Ceiling Diffusers



- All-aluminum construction
- Removable core for concealed mounting
- 4-way air patterns
- Built-in opposed blade damper is standard but also available without a damper
- Bevel frame for surface mount
- Color/Finish: White

See P. 103 for performance data

SKU	Size	With Damper
PSSQCDWU*	6"	Yes
PSSQCDWX*	8"	Yes
PSSQCDLDWX*	8"	No
PSSQCDW10*	10"	Yes
PSSQCDLDW10*	10"	No
PSSQCDW12	12"	Yes
PSSQCDLDW12*	12"	No
PSSQCDW14*	14"	Yes
PSSQCDLDW14*	14"	No
PSSQCDW16*	16"	Yes
PSSQCDLDW16*	16"	No
PSSQCDW18*	18"	Yes
PSSQCDLDW18*	18"	No
PSSQCDW20*	20"	Yes

*Denotes Non-Stock Item

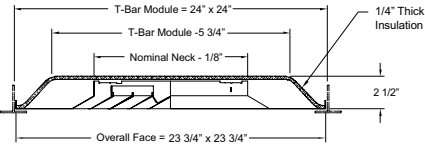

Ceiling Diffusers for T-Bar



- Steel construction
- Size: 24" x 24"
- 4-way air patterns
- Core easily removable with spring loaded latches (no tools required)
- Includes a foil insulated backpan and accepts 6" to 12" field supplied inlet collars
- Color/Finish: White

See P. 105 for performance data

SKU

PSLFSI2424

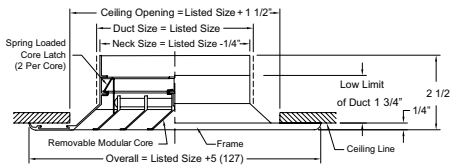

Aluminum Square Ceiling Diffusers for T-Bar



- Highly flexible directional mounting applications ceiling diffuser
- Modular cores can be adjusted to obtain 1, 2-way opposite, 2-way corner, 3 or 4-way air patterns
- Cores are easy to remove with spring loaded latches (no tools required)
- An excellent choice for VAV applications
- Color/Finish: White

See P. 105 for performance data

SKU

Size

PSAMODOBXX

8" x 8"

PSAMODOB1010

10" x 10"

PSAMODOB1212

12" x 12"

PSAMODOB1414

14" x 14"

PSAMODOB1616*

16" x 16"

PSAMODOB1818*

18" x 18"

PSAMODOB2020

20" x 20"

*Denotes Non-Stock Item

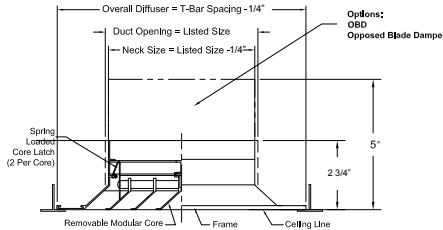

Aluminum Ceiling Diffusers for T-Bar



- Aluminum
- Square back
- Highly flexible directional mounting applications ceiling diffuser
- Modular cores can be adjusted to obtain 1, 2-way opposite, 2-way corner, 3 or 4-way air patterns
- Cores are easy to remove with spring loaded latches (no tools required)
- An excellent choice for VAV applications
- Color/Finish: White

See P. 105 for performance data

SKU	Size	With Opposed Blade Damper
PSAMCTBSBWX* [*]	8" x 8"	Yes
PSAMCTBSBODXX* [*]	8" x 8"	No
PSAMCTBSBW1010* [*]	10" x 10"	Yes
PSAMCTBSBOD1010* [*]	10" x 10"	No
PSAMCTBSBW1212* [*]	12" x 12"	Yes
PSAMCTBSBOD1212* [*]	12" x 12"	No
PSAMCTBSBW1414* [*]	14" x 14"	Yes
PSAMCTBSBOD1414* [*]	14" x 14"	No
PSAMCTBSBW1616* [*]	16" x 16"	Yes
PSAMCTBSBOD1616* [*]	16" x 16"	No
PSAMCTBSBW1818* [*]	18" x 18"	Yes
PSAMCTBSBOD1818* [*]	18" x 18"	No
PSAMCTBSBW2020* [*]	20" x 20"	Yes
PSAMCTBSBOD2020* [*]	20" x 20"	No

*Denotes Non-Stock Item

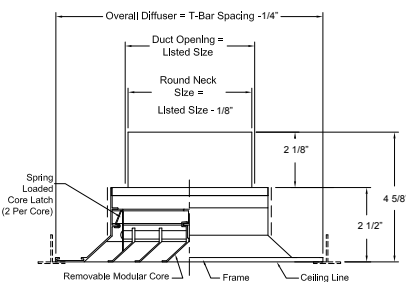

Aluminum T-Bar Modular Core Diffusers with Square to Round Back



- Square to round back
- Highly flexible directional mounting applications ceiling diffuser
- Modular cores can be adjusted to obtain 1, 2-way opposite, 2-way corner, 3 or 4-way air patterns
- Cores are easy to remove with spring loaded latches (no tools required)
- An excellent choice for VAV applications
- Color/Finish: White

See P. 105 for performance data

SKU	Size
PSAMCTBUU* [*]	6" x 6"
PSAMCTBXX	8" x 8"
PSAMCTB1010* [*]	10" x 10"
PSAMCTB1212* [*]	12" x 12"
PSAMCTB1414* [*]	14" x 14"

*Denotes Non-Stock Item

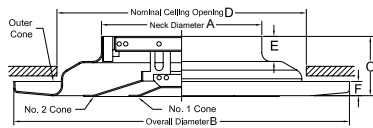

Steel Round Fixed Ceiling Diffusers



- High induction/capacity 2-cone diffuser
- Low profile flush face

See P. 106 for performance data

Size	Dimensions					
	A	B	C	D	E	F
8"	7 3/4"	16 5/8"	2 15/16"	12"	1 1/4"	5/8"
10"	9 3/4"	22 3/16"	3 15/16"	17"	1 1/4"	7/8"
12"	11 3/4"	22 3/16"	3 15/16"	17"	1 1/4"	7/8"
14"	13 3/4"	29 1/4"	4 3/16"	23"	1 1/4"	7/8"
16"	15 3/4"	29 1/4"	4 3/16"	23"	1 1/4"	7/8"
18"	17 3/4"	34 1/2"	4 5/8"	28"	1 1/4"	1"

SKU	Size	A	B	C	D	E	F
PSRADWX	8"	7 3/4"	16 5/8"	2 15/16"	12"	1 1/4"	5/8"
PSRADW10	10"	9 3/4"	22 3/16"	3 5/16"	17"	1 1/4"	7/8"
PSRADW12	12"	11 3/4"	22 3/16"	3 5/16"	17"	1 1/4"	7/8"
PSRADW14	14"	13 3/4"	29 1/4"	4 3/16"	23"	1 1/4"	7/8"
PSRADW16	16"	15 3/4"	29 1/4"	4 3/16"	23"	1 1/4"	7/8"
PSRADW18*	18"	17 3/4"	34 1/2"	4 3/16"	28"	1 1/4"	1"

*Denotes Non-Stock Item

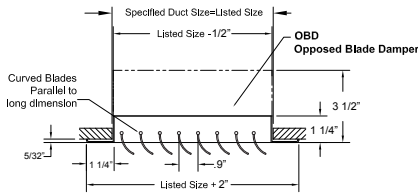

Extruded Aluminum Curved Blades with Opposed Blade Damper 1-Way



- Rollformed aluminum blades
- Individual adjustable curved blades pivot on .9" centers
- Opposed blade damper controls volume without altering air pattern – screwdriver damper operator
- Color/Finish: White

Additional engineering data is available upon request through your sales associate

SKU	Size
PSA1COBEWXU*	8" x 6"
PSA1COBEW12X*	12" x 8"
PSA1COBEW14U*	14" x 6"
PSA1COBEW16U*	16" x 6"
PSA1COBEW16X*	16" x 8"

*Denotes Non-Stock Item

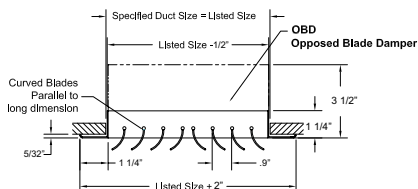

Extruded Aluminum Curved Blades with Opposed Blade Damper 2-Way



- Rollformed aluminum blades
- Individual adjustable curved blades pivot on .9" centers
- Opposed blade damper controls volume without altering air pattern – screwdriver damper operator
- Color/Finish: White

Additional engineering data is available upon request through your sales associate

SKU	Size
PSA2COBEW10X*	10" x 8"
PSA2COBEW12U*	12" x 6"

*Denotes Non-Stock Item

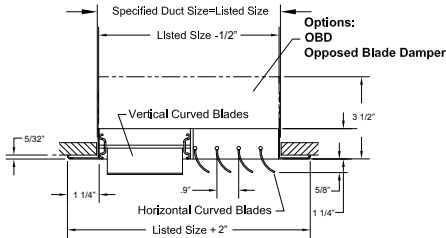

Extruded Aluminum Curved Blades with Multi-Shutter Damper 3-Way



- Rollformed aluminum blades
- Individual adjustable curved blades pivot on .9" centers
- Multi-shutter damper blades adjust from fully open to closed
- Color/Finish: White

Additional engineering data is available upon request through your sales associate

SKU	Size
PSA3CMSEW14U*	14" x 6"
PSA3CMSEW1410*	14" x 10"

*Denotes Non-Stock Item

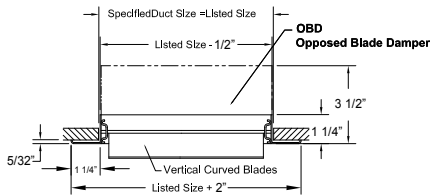

Extruded Aluminum Curved Blades with Opposed Blade Damper 4-Way



- Rollformed aluminum blades
- 4-way air patterns
- Individual adjustable curved blades pivot on .9" centers
- Opposed blade damper controls volume without altering air pattern – screwdriver damper operator
- Color/Finish: White

Additional engineering data is available upon request through your sales associate

SKU	Size
PSA4COBWUU	6" x 6"
PSA4COBWXX	8" x 8"
PSA4COB1010	10" x 10"
PSA4COBW1212	12" x 12"
PSA4COBW1414	14" x 14"
PSA4COBW1616*	16" x 16"
PSA4COBW1818*	18" x 18"
PSA4COBW2020*	20" x 20"

*Denotes Non-Stock Item

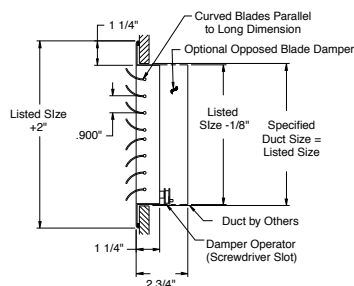

Extruded Aluminum Curved Blades with Multi-Shutter Damper 4-Way



- Rollformed aluminum blades
- 4-way air patterns
- Individual adjustable curved blades pivot on .9" centers
- Multi-shutter damper controls volume without altering air pattern – screwdriver damper operator
- Color/Finish: White

Additional engineering data is available upon request through your sales associate

SKU	Size
PSA4CMSEWUU*	6" x 6"
PSA4CMSEW1010*	10" x 10"

*Denotes Non-Stock Item

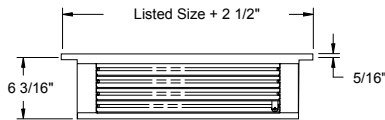

Ceiling Diffuser Boxes 4-Way



- Heavy-duty steel construction
- Adjustable dampers provide directional airflow or closure capabilities
- Mounting holes provided for easy installation
- Color/Finish: White

See P. 106 for performance data

SKU	Size
PSCDBXW1414	14" x 14"
PSCDBXW1616	16" x 16"
PSCDBXW1818	18" x 18"
PSCDBXW2020	20" x 20"
PSCDBXW2222	22" x 22"
PSCDBXW2424	24" x 24"

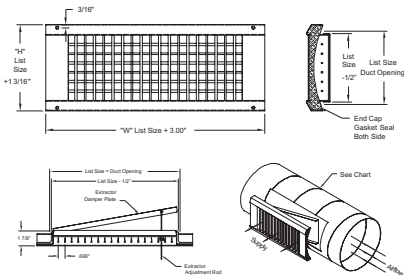

Galvanized Steel Double Deflection Spiral Duct Diffusers



- Offers superior performance in exposed duct applications offering a clean, low profile appearance
- Front blades are vertical
- Units can be easily installed in round duct diameters 10" to 48"
- Integral gasket seals grille tightly to duct
- Units include built-in extractor to allow accurate balancing and uniform air flow

See P. 107 for performance data

SKU	Size
PSGDDSD14P	14" x 4"
PSGDDSD14U	14" x 6"
PSGDDSD18P	18" x 4"
PSGDDSD18U	18" x 6"
PSGDDSD26P*	26" x 4"
PSGDDSD26U	26" x 6"
PSGDDSD34P*	34" x 4"

*Denotes Non-Stock Item

Minimum/Maximum Duct Diameter:

		Width														
		10"	12"	14"	16"	18"	20"	24"	30"	36"	38"	40"	42"	44"	46"	48"
Height	3"	6/24	6/24	6/24	6/24	6/24	6/24	6/24	6/24	6/24	6/24	6/24	6/24	6/24	6/24	6/24
	4"	8/24	8/24	8/24	8/24	8/24	8/24	8/24	8/24	8/24	8/24	8/24	8/24	8/24	8/24	8/24
	6"	12/24	12/24	12/24	12/24	12/24	12/24	12/24	12/24	12/24	12/24	12/24	12/24	12/24	12/24	12/24
	8"	-	-	20/36	20/36	20/36	20/36	20/36	20/36	20/36	20/36	20/36	20/36	20/36	20/36	20/36
	10"	-	-	-	-	30/48	30/48	30/48	30/48	30/48	30/48	30/48	30/48	30/48	30/48	30/48
	12"	-	-	-	-	42/48	42/48	42/48	42/48	42/48	42/48	42/48	42/48	42/48	42/48	42/48



Aluminum Horizontal Registers



- Constructed with an extruded aluminum border and airfoil deflection blades
- Individually adjustable fins on .666" centers
- Opposed blade damper controls volume without altering air pattern - screwdriver operator
- Color/Finish: White

Additional engineering data is available upon request through your sales associate

SKU	Size
PSAHOBW1212*	12" x 12"
PSAHOBW1414*	14" x 14"
PSAHOBW2020*	20" x 20"
PSAHOBW2424*	24" x 24"

*Denotes Non-Stock Item

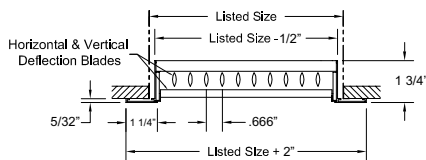
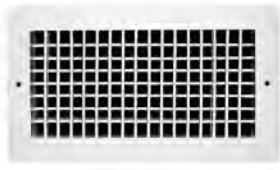

Aluminum Vertical/Horizontal Sidewall Supplies



- Constructed with an extruded aluminum border and airfoil deflection blades
- Our premier product, offering superior construction and high performance with aerodynamically shaped extruded deflection blades
- An excellent choice for projects requiring superior performance and aesthetics
- Color/Finish: White

See P. 107 for performance data

SKU	Size	With Opposed Blade Damper
PSAVHOBWUU	6" x 6"	Yes
PSAVHOBWXU	8" x 6"	Yes
PSAVHOBWXX	8" x 8"	Yes
PSAVHOBW10U	10" x 6"	Yes
PSAVHOBW10X	10" x 8"	Yes
PSAVHOBW1010	10" x 10"	Yes
PSAVHW1010	10" x 10"	No
PSAVHOBW12U	12" x 6"	Yes
PSAVHOBW12X	12" x 8"	Yes
PSAVHOBW1212	12" x 12"	Yes
PSAVHW1212	12" x 12"	No
PSAVHOBW14U	14" x 6"	Yes
PSAVHOBW14X	14" x 8"	Yes
PSAVHW14X	14" x 8"	No
PSAVHOBW16U	16" x 6"	Yes
PSAVHOBW16X	16" x 8"	Yes
PSAVHOBW18U	18" x 6"	Yes
PSAVHOBW18X	18" x 8"	Yes
PSAVHOBW20U	20" x 6"	Yes
PSAVHOBW24U	24" x 6"	Yes
PSAVHOBW24X	24" x 8"	Yes

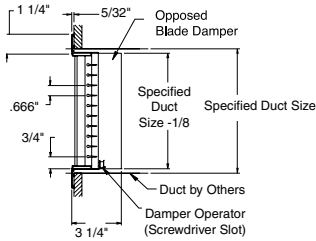

Aluminum Horizontal/Vertical Sidewall Supplies



- Constructed with an extruded aluminum border and airfoil deflection blades
- .666" fins spacing
- Opposed blade damper controls volume without altering air pattern – screwdriver operator
- Both front and rear deflector sets have individually adjustable fins
- Color/Finish: White

See P. 107 for performance data

SKU

Size

PSAHVOBW12P*	12" x 4"
PSAHVOBW12S*	12" x 5"
PSAHVOBW12U*	12" x 6"
PSAHVOBW14X*	14" x 8"
PSAHVOBW18U*	18" x 6"
PSAHVOBW18X*	18" x 8"

*Denotes Non-Stock Item

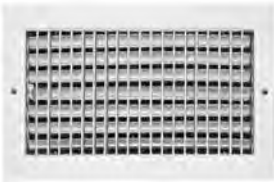

Vertical Blade Supply Registers with Opposed Blade Damper



- Individually adjustable fins on .666" centers
- Opposed blade damper controls volume without altering air pattern - screwdriver operator
- Rollformed blades
- Color/Finish: White

Additional engineering data is available upon request through your sales associate

SKU

Size

PSVOBWUU	6" x 6"
PSVOBWXP	8" x 4"
PSVOBW XU	8" x 6"
PSVOBWXX	8" x 8"
PSVOBW10U	10" x 6"
PSVOBW1010	10" x 10"
PSVOBW12U	12" x 6"
PSVOBW12X	12" x 8"
PSVOBW1212	12" x 12"
PSVOBW14U	14" x 6"

SKU

Size

PSVOBW14X	14" x 8"
PSVOBW1414	14" x 14"
PSVOBW16U	16" x 6"
PSVOBW16X	16" x 8"
PSVOBW18U	18" x 6"
PSVOBW18X	18" x 8"
PSVOBW20U	20" x 6"
PSVOBW20X	20" x 8"
PSVOBW24U	24" x 6"
PSVOBW24X	24" x 8"

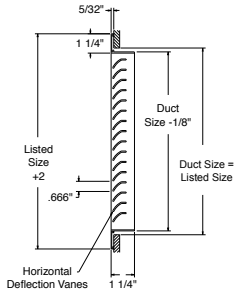

Aluminum Fixed Horizontal Blade Returns



- Extruded aluminum frame and blades
- .666" fin spacing
- Horizontal fins are permanently fixed at 45° angle
- Color/Finish: White

See P. 108 for performance data

SKU	Size	SKU	Size
PSAH45WUU	6" x 6"	PSAH45W2012	20" x 12"
PSAH45WXP	8" x 4"	PSAH45W2014	20" x 14"
PSAH45WXX	8" x 8"	PSAH45W2016	20" x 16"
PSAH45W10P*	10" x 4"	PSAH45W2020	20" x 20"
PSAH45W10U	10" x 6"	PSAH45W2025*	20" x 25"
PSAH45W10X*	10" x 8"	PSAH45W24U	24" x 6"
PSAH45W1010	10" x 10"	PSAH45W24X	24" x 8"
PSAH45W12P*	12" x 4"	PSAH45W2410	24" x 10"
PSAH45W12U	12" x 6"	PSAH45W2412	24" x 12"
PSAH45W12X	12" x 8"	PSAH45W2414	24" x 14"
PSAH45W1210*	12" x 10"	PSAH45W2416	24" x 16"
PSAH45W1212	12" x 12"	PSAH45W2418	24" x 18"
PSAH45W1220*	12" x 20"	PSAH45W2420	24" x 20"
PSAH45W1224	12" x 24"	PSAH45W2424	24" x 24"
PSAH45W14U*	14" x 6"	PSAH45W2512*	25" x 12"
PSAH45W14X	14" x 8"	PSAH45W2514*	25" x 14"
PSAH45W1410	14" x 10"	PSAH45W2516*	25" x 16"
PSAH45W1412*	14" x 12"	PSAH45W2520*	25" x 20"
PSAH45W1414	14" x 14"	PSAH45W2626*	26" x 26"
PSAH45W1420	14" x 20"	PSAH45W2814	28" x 14"
PSAH45W1424*	14" x 24"	PSAH45W30U*	30" x 6"
PSAH45W1425*	14" x 25"	PSAH45W30X	30" x 8"
PSAH45W16U*	16" x 6"	PSAH45W3010	30" x 10"
PSAH45W16X*	16" x 8"	PSAH45W3012	30" x 12"
PSAH45W1610*	16" x 10"	PSAH45W3014	30" x 14"
PSAH45W1612*	16" x 12"	PSAH45W3016	30" x 16"
PSAH45W1616	16" x 16"	PSAH45W3018	30" x 18"
PSAH45W18U*	18" x 6"	PSAH45W3020	30" x 20"
PSAH45W18X*	18" x 8"	PSAH45W3025*	30" x 25"
PSAH45W1810*	18" x 10"	PSAH45W36U*	36" x 6"
PSAH45W1812*	18" x 12"	PSAH45W36X	36" x 8"
PSAH45W1814*	18" x 14"	PSAH45W3610	36" x 10"
PSAH45W1818	18" x 18"	PSAH45W3612	36" x 12"
PSAH45W1824	18" x 24"	PSAH45W3614	36" x 14"
PSAH45W20P*	20" x 4"	PSAH45W3616*	36" x 16"
PSAH45W20U*	20" x 6"	PSAH45W3620*	36" x 20"
PSAH45W20X	20" x 8"	PSAH45W4020*	40" x 20"
PSAH45W2010	20" x 10"		

*Denotes Non-Stock Item



Aluminum Fixed Horizontal Blade Returns for T-Bar



- Extruded aluminum frame and blades
- .666" fin spacing
- Horizontal fins are permanently fixed at 45° angle
- Color/Finish: White

See P. 108 for performance data

SKU	Size
PSAH45TBXX	8" x 8"
PSAH45TB1010	10" x 10"
PSAH45TB1212	12" x 12"
PSAH45TB1414	14" x 14"
PSAH45TB1224*	12" x 24"
PSAH45TB	24" x 24"
PSAH45TB2448*	24" x 48"

*Denotes Non-Stock Item



Aluminum Fixed Horizontal Blade Return Filter Grilles



- Extruded aluminum frame and blades
- Concealed mounting
- .666" fin spacing
- Horizontal fins are permanently fixed at 45° angle
- Accepts standard 1" filter (not included)
- Hinged face with 1/4 turn latches for quick filter changes
- Color/Finish: White

See P. 108 for performance data

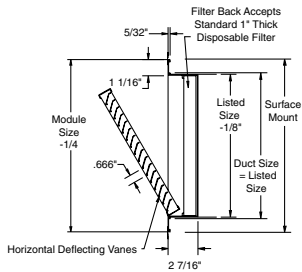

SKU	Size	SKU	Size
PSAH45FGW1010	10" x 10"	PSAH45FGW2222*	22" x 22"
PSAH45FGW1212	12" x 12"	PSAH45FGW2412	24" x 12"
PSAH45FGW1224	12" x 24"	PSAH45FGW2416*	24" x 16"
PSAH45FGW14X	14" x 8"	PSAH45FGW2418	24" x 18"
PSAH45FGW1414	14" x 14"	PSAH45FGW2424*	24" x 24"
PSAH45FGW1420*	14" x 20"	PSAH45FGW2430	24" x 30"
PSAH45FGW1424*	14" x 24"	PSAH45FGW2510*	25" x 10"
PSAH45FGW1430*	14" x 30"	PSAH45FGW2518*	25" x 18"
PSAH45FGW1616*	16" x 16"	PSAH45FGW3012*	30" x 12"
PSAH45FGW1630*	16" x 30"	PSAH45FGW3016*	30" x 16"
PSAH45FGW1818	18" x 18"	PSAH45FGW3018	30" x 18"
PSAH45FGW1824	18" x 24"	PSAH45FGW3020*	30" x 20"
PSAH45FGW2020	20" x 20"	PSAH45FGW3620*	36" x 20"
PSAH45FGW2025	20" x 25"	PSAH45FGW4020*	40" x 20"
PSAH45FGW2030*	20" x 30"	PSAH45FGW4824*	48" x 24"

*Denotes Non-Stock Item

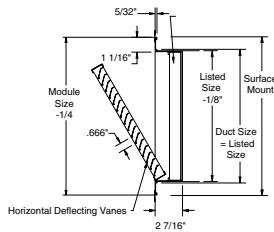

Aluminum Fixed Horizontal Blade Return T-Bar Filter Grilles



- Extruded aluminum
- .666" fin spacing
- Horizontal fins are permanently fixed at 45° angle
- Accepts standard 1" or 2" filters (not included)
- Hinged face with 1/4 turn latches for quick filter changes
- Color/Finish: White

See P. 108 for performance data

SKU	Size
PSAH45FTB2020	20" x 20"
PSAH45FTB2424	24" x 24"
PSAH45FTB2448	24" x 48"

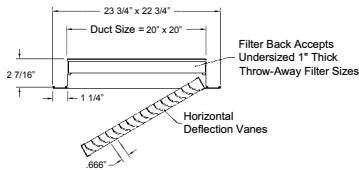

Steel Face Filter Grilles for T-Bar Ceilings



- Steel construction
- Size: 20" x 20"
- 3/4" fin spacing
- Horizontal fins are permanently fixed at a 45° angle
- Accepts disposable 1" filter (not included)
- Hinged face with 1/4 turn latches for quick filter changes
- Color/Finish: White

See P. 108 for performance data

SKU
PSFGFBW2020

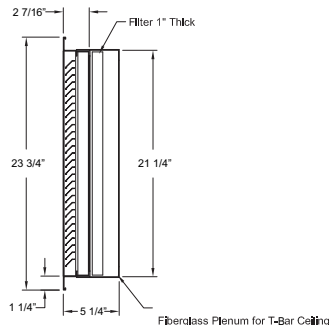

Steel Face Filter Grilles for T-Bar Ceilings, Insulated



- Steel construction
- Size: 20" x 20"
- .666" fin spacing
- Horizontal fins are fixed at a 45° angle
- 24" x 24" lay-in T-Bar
- Concealed hinges
- R6 insulated 1" fiberglass plenum to accept 6" to 18" round collars (supplied by others)
- Uses standard 20" x 20" x 1" filter (not included)
- Color/Finish: White

See P. 108 for performance data

SKU
PSFGFBW2020

Commercial Products

Return Air Grilles · Cube Core Return Grilles

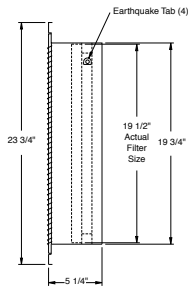

Steel Face Filter Grilles for T-Bar Ceilings, Perforated



- Steel construction
- Size: 24" x 24"
- Concealed hinges
- R6 insulated 1" fiberglass plenum to accept 6" to 18" round collar (by others)
- Color/Finish: White

See P. 103 for performance data

SKU

PSPFGFBR

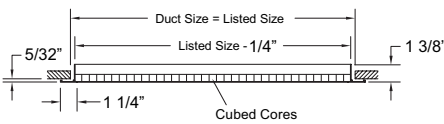
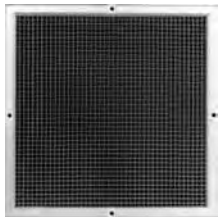

Aluminum Egg Crate Returns



- Extruded aluminum frame
- Available for surface mounting
- Attractive cube core design for maximum free area (90%)
- 1/2" x 1/2" x 1/2" core
- Color/Finish: White

See P. 108 for performance data

SKU

Size

PSAEC5UU*	6" x 6"
PSAEC5XX*	8" x 8"
PSAEC51010*	10" x 10"
PSAEC51212	12" x 12"
PSAEC51414	14" x 14"
PSAEC51424*	14" x 24"
PSAEC51430*	14" x 30"
PSAEC51616*	16" x 16"
PSAEC51818*	18" x 18"
PSAEC51836*	18" x 36"

SKU

Size

PSAEC52014*	20" x 14"
PSAEC52016*	20" x 16"
PSAEC52020*	20" x 20"
PSAEC52210	22" x 10"
PSAEC52410*	24" x 10"
PSAEC52412*	24" x 12"
PSAEC52414	24" x 14"
PSAEC52424*	24" x 24"
PSAEC53014*	30" x 14"
PSAEC53020*	30" x 20"

*Denotes Non-Stock Item

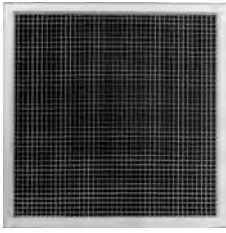

Aluminum Cube Core Return Grilles for T-Bar Lay-in Ceilings, Diffuser



- Extruded aluminum frame
- Attractive cubed core design for maximum free area (90%)
- 1/2" x 1/2" x 1/2" cube core
- Color/Finish: White

See P. 108 for performance data

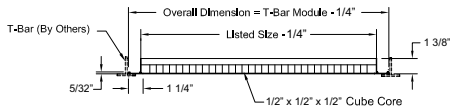

SKU

PSAEC5TB2210

Size

22" x 10"

PSAEC5TB2222

22" x 22"

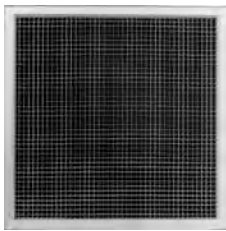

Aluminum Cube Core Return Grilles for T-Bar Lay-in Ceilings, Insulated



- Extruded aluminum frame
- Size: 22" x 22"
- Attractive cubed core design for maximum free area (90%)
- 1/2" x 1/2" x 1/2" cube core
- Includes a foil insulated backpan and accept 6" to 12" field supplied inlet collars
- Color/Finish: White

See P. 108 for performance data

SKU

PSAEC5IB2222

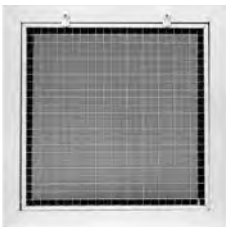

Aluminum Cube Core Return Filter Grilles



- Extruded aluminum frame
- Concealed mounting
- Attractive cubed core design for maximum free area (90%)
- 1/2" x 1/2" x 1/2" cube core
- Accepts disposable 1" filters (not included)
- Hinged face with 1/4 turn latches for quick filter changes
- Color/Finish: White

See P. 108 for performance data

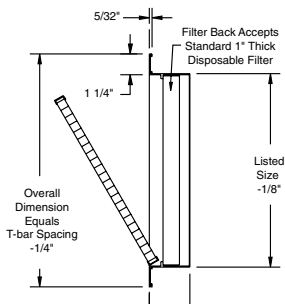

SKU

PSAEC5FG1212*

Size

12" x 12"

PSAEC5FG1414*

14" x 14"

PSAEC5FG1420*

14" x 20"

PSAEC5FG2012*

20" x 12"

PSAEC5FG2014

20" x 14"

PSAEC5FG2020*

20" x 20"

PSAEC5FG2025

20" x 25"

SKU

PSAEC5FG2412

Size

24" x 12"

PSAEC5FG2414

24" x 14"

PSAEC5FG2416*

24" x 16"

PSAEC5FG2420

24" x 20"

PSAEC5FG3014

30" x 14"

PSAEC5FG3020

30" x 20"

PSAEC5FG3024

30" x 24"

*Denotes Non-Stock Item

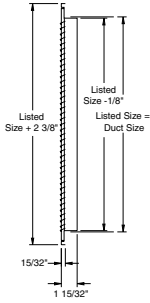

Stamped Steel Face Filter Grilles for T-Bar Lay-In



- Steel construction
- Stamped face has fins on 1/2" centers
- Concealed hinges and latches
- Color/Finish: White

See P. 109 for performance data

SKU	Size
PSFGTBW1414*	14" x 14"
PSFGTBW2020	20" x 20"

*Denotes Non-Stock Item

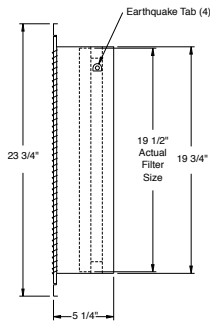

Stamped Steel Face Filter Grilles with Fiberglass Plenum for T-Bar Ceilings



- Steel construction
- Stamped face has fins on 1/2" centers
- Concealed hinges and latches
- R6 Insulated 1" fiberglass plenum to accept 6" to 18" round collars (supplied by others)
- Aluminum foil vapor barrier
- Uses standard 20" x 20" x 1" filter (not included)
- Color/Finish: White

See P. 109 for performance data

SKU	Size
PSFGTBIW1010*	10" x 10"
PSFGTBIW2020	20" x 20"
PSFGTBIW2030*	20" x 30"
PSFGTBIW2414*	24" x 14"
PSFGTBIW3024*	30" x 24"

*Denotes Non-Stock Item

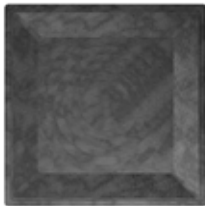

Fiberglass Backpans



- Size: 24" x 24"
- Formed backpan with foil backing
- R6 insulation

SKU
PSFGBP

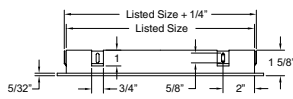
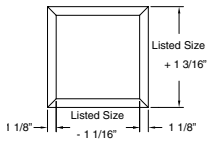
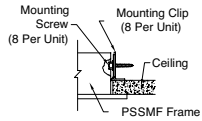

T-Bar Plaster Frames



- Aluminum construction
- Size: 24" x 24"
- Includes 8 screws & angle brackets

SKU

PSSMF2424

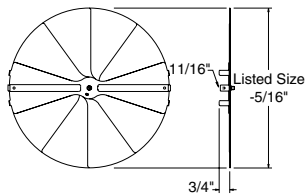

Radial Shutter Dampers



- Coated steel construction
- 5 radial style blades
- Blades are adjusted through diffuser face
- Mounting tabs permit easy attachment to ceiling diffusers

SKU

Size

PSRADU

6"

PSRADX

8"

PSRAD10

10"

PSRAD12

12"



Inlet Collars



- Steel construction
- 1 1/4" high collar permits easy flex connection

SKU

Size

PSSICRU

6"

PSSICRW

7"

PSSICRX

8"

PSSICRY*

9"

PSSICR10

10"

PSSICR12

12"

PSSICR14

14"

*Denotes Non-Stock Item

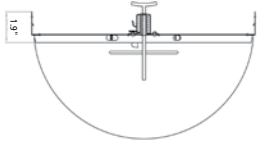

Butterfly Dampers



- Adjustable butterfly damper
- Removable handle
- Color/Finish: Brown

SKU	Size	A	B
PSDBU	6"	5.75"	3.89"
PSDBW	7"	6.75"	3.44"
PSDBX	8"	7.75"	4.89"
PSDB10	10"	9.76"	5.86"
PSDB12	12"	11.77"	6.98"
PSDB14	14"	13.75"	7.91"



Snap-In Push Pins



- Attaches PSSICR collar
- Package Quantity: 100

SKU
PSSIPP



Inlet Dampers



- Size: 6"
- For use in round duct
- Includes: damper blade with two bearings, handle, washer and wing nut (ships assembled)

Additional engineering data is available upon request through your sales associate

SKU
PSIDU



Hardware



- Easily mounts onto bearing edge of existing dampers
- Acceptable for use on dampers up to 22 ga
- Includes: washer, handle, wing nut and 5/16" bearings

SKU	Type
PSLSR1B	5/16" Lock Side Regulator Set (1 Bearing)
PSLSR2B	5/16" Lock Side Regulator Set (2 Bearings)
PSLSWSHR	Washer Only



Frame Styles:

PSLSD-12-1 1 1/8" Border - Concealed Surface Mount

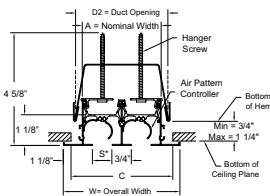

PSLSD-12-6 T-Bar Lay-In 1 1/8" Border - Concealed Mount

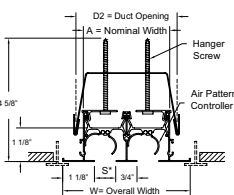

Linear Slot Diffusers



- Excellent choice for continuous linear slot applications
- Available in 1 to 8 slots
- Units are available in 2' and 4' lengths
- Pattern controllers on supply units are aluminum and are adjustable from the face of the diffuser and can be set to adjust volume or throw direction from vertical to horizontal
- Optional PSBP and insulated PSBPI factory supplied boot plenums are available
- Color/Finish: White border with black pattern controller
- **Sizes: Call your sales associate for sizes and availability**

SKU

PSLSD

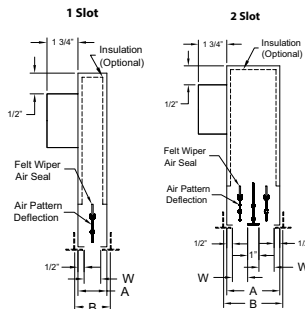

Adjustable Pattern Controllers, Supplies for T-Bar



- Heavy duty extruded aluminum pattern controller and gasket for tight horizontal discharge pattern
- Field adjustable pattern controllers allow adjustable horizontal and vertical throw
- Units available in 1 and 2 slots to meet a wide range of applications and capabilities
- Double hem face construction for rigidity and straightness
- One-piece plenum construction ensures tight fit in ceiling grid
- Optional 1/4" insulation on lay-in units
- Lay-in integrates into 1" T-Bar ceiling
- Color/Finish: White tees with black borders and plenum interior
- **Sizes: Call your sales associate for sizes and availability**

SKU

PSAPCA

PSAPCSI

Insulated

No

Yes

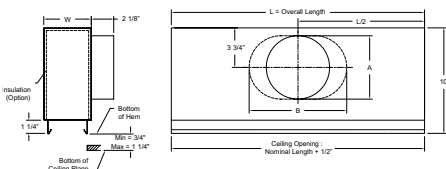

Steel Boot Plenums



- The PSBP (non-insulated) and PSBPI (insulated) boot plenums are designed to connect the series PSLSD linear slot diffusers to the duct supply or return system
- Units provide an even distribution of air into the PSLSD diffuser to maximize induction and occupant comfort
- The PSBPI boot plenum is fully insulated (including the end caps)
- Units can be used for both duct or plenum returns
- Factory tested and manufactured PSBP/PSBPI are built to fit securely into the PSLSD diffusers, reducing installation cost and minimizing leakage
- Available with optional quadrant locking damper
- PSBP/PSBPI ship separately from PSLSD linear slot diffuser and require field attachment
- **Sizes: Call your sales associate for sizes and availability**

SKU

PSBP

PSBPI

Insulated

No

Yes



Sanitary Maintenance Solutions



Private Label Brands



FNW



FNW Hangers, Supports & Strut Accs.



PROFLO

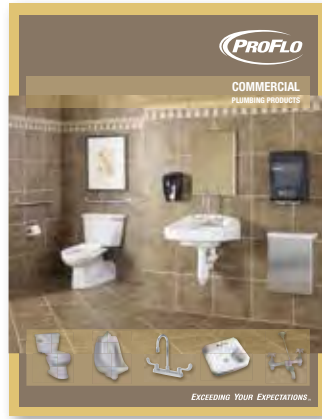

PROFLO Commercial



PROFLO ACCUFIT

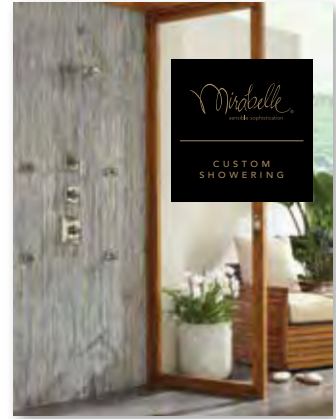

Mirabelle Custom Showering



Mirabelle

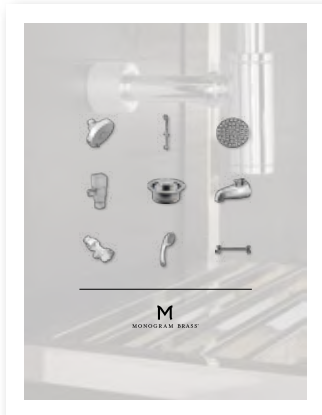

Monogram Brass

FERGUSON®

WE'RE MORE THAN JUST PLUMBING.

To view these catalogs and more,
visit us at FERGUSON.COM



Park Harbor

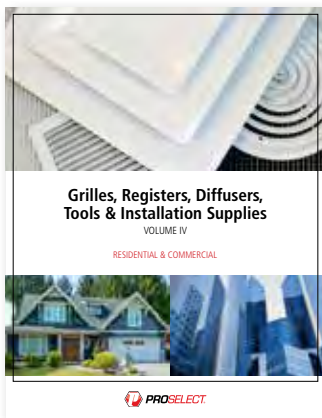

ProSelect Grilles, Registers & Diffusers



Utility Contractor Tools & Supplies



HVAC Equipment, Parts & Supplies



Tools & Installation Supplies



Pages 61-78

Acid Brushes



- 3/8"
- For use on flux, pastes and other chemicals
- Hollow tin handle
- 100% horse hair bristle

SKU

PS10001

Fitting Brushes



- Concave surface plastic handle
- Tempered high carbon kinked steel bristles
- Galvanized 2-ply wire stem

SKU

Size

PS0644	1/4"
PS0645	3/8"
PS0646	1/2"
PS0648	3/4"
PS0649	1"
PS0650	1 1/4"
PS0651	1 1/2"
PS0652	2"
PS0653	2 1/2"

Chip Brushes



- Wood handle chip brush
- Natural bristle

SKU

Size

PS67191	1/2"
PS67192	1"
PS67193	1 1/2"
PS67194	2"
PS67195	2 1/2"
PS67196	3"
PS67198	4"

Fitting Brushes



- 2-ply wire loop handle
- Tempered high carbon kinked steel bristles
- Galvanized 2-ply wire stem

SKU

Size

Pkg Qty

PS546	1/2"	1
PS546BP	1/2"	100
PS548	3/4"	1
PS548BP	3/4"	100
PS549	1"	1
PS550	1 1/4"	1
PS551	1 1/2"	1
PS552	2"	1



Fitting Brushes



- Hex shaft
- Tempered high carbon kinked steel bristles
- Galvanized 2-ply wire stem

SKU	Size
PS9546	1/2"
PS9548	3/4"



Fitting Brushes



- Heavy duty
- Flat surface plastic handle is easy to hold
- Tempered high carbon straight steel bristles
- Galvanized 4-ply wire stem

SKU	Size
PSHDFBD	1/2"
PSHDFBF	3/4"
PSHDFBG	1"
PSHDFBH	1 1/4"
PSHDFBJ	1 1/2"
PSHDFBK	2"



Pipe Dope Brushes



- 3/4"
- For use on flux or other pastes
- Round tapered wooden handle
- 100% horse hair bristle

SKU
PS10007



Condensate Pumps



- 115V, 60W
- Head Capacity: 15'
- 1/2 gallon tank capacity
- Removable 3/8" (9.5mm) barbed check valve
- Reversible tank cover with 3 inlet drain holes for flexible installation
- Rated for water temperature up to 140°F
- Thermal overload protection
- 6' power cord with 3 prong molded plug
- ABS tank, motor cover and volute with stainless steel shaft
- UL Listed

SKU
PSCP15



Condensate Pumps



- 115V, 93W
- Head Capacity: 20'
- 3/10 gallon tank capacity
- Removable 3/8" (9.5mm) barbed check valve
- Thermal overload protection
- Safety switch
- 6' power cord with 3 prong molded plug
- ABS tank with stainless steel shaft

SKU
PSCP20LPWS



Condensate Pumps



- 115V
- 1/2 gallon tank capacity
- Automatic snap-action switch
- Removable 3/8" (9.5mm) barbed check valve
- Reversible tank cover with 3 inlet drain holes for flexible installation
- Rated for water temperature up to 140°F
- Thermal overload protection
- Safety switch
- ABS tank, motor cover and volute with stainless steel shaft
- UL Listed

SKU	Head Capacity	Watts
PSCP15WS	15'	60W
PSCP20WS	20'	73W



Condensate Pumps



- 115V
- 1/2 gallon tank capacity
- Automatic snap-action switch
- Removable 3/8" (9.5mm) barbed check valve
- Reversible tank cover with 3 inlet drain holes for flexible installation
- Rated for water temperature up to 140°F
- Thermal overload protection
- Includes 20' (6.1 m) of 3/8" ID (9.5mm) clear tubing
- ABS tank, motor cover and volute with stainless steel shaft
- UL Listed

SKU	Head Capacity	Watts
PSCP15WS20T	15'	60W
PSCP20WS20T	20'	73W



Condensate Pumps



- 115V, 148W
- Head Capacity: 24'
- 1 gallon tank capacity
- Snap-action safety switch
- Thermal overload protection
- 6' power cord with 3 prong molded plug
- ABS tank, volute and switch cover with galvanized steel tank cover and stainless steel shaft

SKU
PSCP24WS

Condensate Pumps



- 115V, 185W
- Head Capacity: 45'
- 1 gallon tank capacity
- Snap-action safety switch
- Thermal overload protection
- 3/8" (9.5mm) discharge copper tube
- 6' power cord with 3 prong molded plug
- ABS tank, volute and switch cover with galvanized steel tank cover and stainless steel shaft

SKU

PSCP45WS

Condensate Pumps



- Mini-Split
- Ductless
- For intermittent operation, maximum 50% duty cycle
- Condensate produced in application must be no more than half the pump's flow rate for any given head
- Use with most mini-split air conditioning units up to 25,000 BTU/hr
- Self-priming pump can be placed up to 3' above reservoir
- Kit includes suction tubing, vent tubing, drain tubing, tubing adapter and safety switch

SKU

Watts

Volts

PSCPMS115

19W

115V

PSCPMS230

20W

230V

Condensate Pumps



- Removes condensate from wall mount air conditioners up to 34,000 BTU
- Amps: 0.1A
- Volts: 230V
- Maximum Pressure: 15.2 psi
- Mounts on wall underneath air handler
- Clear, extra large reservoir for easy, visual inspection
- Safety alarm ready
- Easy to remove cover hides pump
- Requires no tools to service
- Includes 5/16" inlet tubing, universal-fit drain hose adapter, 5/32" discharge tubing with 1/4" ID tubing adapter and 6' power & safety overflow connection cables

SKU

PSCPMSOP230

Condensate Safety Switches



- Low voltage
- Can install switch to activate audible and/or visual alarm
- 72" leads
- ABS housing, polyethylene float and lead wires

SKU

PSCP720FSS

Condensate P-Traps



- 3/4" PVC
- For condensate lines

SKU

PF42860

Condensate Running Traps



- 3/4" PVC
- For condensate lines

SKU

PF42861

Ball Valves



- 2-piece full port 600 WOG brass
- Rated 150 WSP
- FM, UL, CSA rated (410A only)
- Optional locking device, t-handle and stem extension

SKU

End Connection

Size

FNW410A

NPT

1/4" - 4"

FNW411A

Sweat

1/2" - 3"

Ball Valves



- Low lead 2-piece standard port 400 WOG valve with compression ends
- Includes drain & cap
- Adjustable packing
- Sizes: 1/2", 3/4" & 1"
- NSF 61 Annex G certified

SKU

FNWX480A

Ball Valves



- Low lead 2-piece full port 600 WOG brass
- Rated 150 WSP
- Dual O-ring packing
- CSA rated (X415 only)
- FM rated to 400 psi (X415 only)
- NSF 61 Annex G certified

SKU

End Connection

Size

FNWX415

NPT

1/4" - 4"

FNWX416

Sweat

1/2" - 3"

Tools & Installation Supplies

Valves · Condenser Pads · Cable Ties



Ball Valves

FNW™

- 2-piece full port 400 WOG pump isolation
- Integral pump flange connection
- Includes t-handle, gasket and bolts
- Eases pump installation and removal
- Sizes: 3/4" - 1 1/2"

SKU End Connection

FNW470 FNPT

FNW475 Sweat



Ball Valves

FNW™

- 2-piece full port 600 WOG pump isolation with rotating flange
- Integral rotating pump flange connection
- Includes t-handle (excludes 1 1/2"), gasket and bolts
- Sizes: 3/4" - 1 1/2"

SKU End Connection

FNW490 FNPT

FNW495 Sweat



Ball Valves

FNW™

- Low lead full port 200 psi
- For copper, CPVC and PEX pipe
- Includes removal tool
- Blow-out proof stem
- Adjustable packing
- Sizes: 1/2", 3/4" and 1"

SKU

FNWX485A



Cable Ties



- High tensile strength
- Manufactured from type 6/6 nylon
- UL181B approved on 36" and 48" ties for HVAC industry

SKU	Size	Pkg Qty	Color/Finish
PSCTBV	7 1/2"	100	Black
PSCTBV1000	7 1/2"	1,000	Black
PSCTB11	11"	100	Black
PSCTB14	14 1/2"	100	Black
PSCTB24	24"	50	Black
PSCTB36	36"	50	Black
PSCTN36	36"	50	Natural
PSCTB48	48"	50	Black
PSCTN48	48"	50	Natural



Condenser Pads



- For indoor and outdoor use
- Injection molded polypropylene
- Color/Finish: Gray

SKU	Size
PSCPE18383	18" L x 38" W x 3" H
PSCPE24242	24" L x 24" W x 2" H
PSCPE24243	24" L x 24" W x 3" H
PSCPE24302	24" L x 30" W x 2" H
PSCPE24362	24" L x 36" W x 2" H
PSCPE24363	24" L x 36" W x 3" H
PSCPE26262	26" L x 26" W x 2" H
PSCPE30302	30" L x 30" W x 2" H
PSCPE30303	30" L x 30" W x 3" H
PSCPE30362	30" L x 36" W x 2" H
PSCPE30402	30" L x 40" W x 2" H
PSCPE30403	30" L x 40" W x 3" H
PSCPE32322	32" L x 32" W x 2" H
PSCPE32323	32" L x 32" W x 3" H
PSCPE32382	32" L x 38" W x 2" H
PSCPE32442	32" L x 44" W x 2" H
PSCPE32443	32" L x 44" W x 3" H

SKU	Size
PSCPE34342	34" L x 34" W x 2" H
PSCPE36362	36" L x 36" W x 2" H
PSCPE36363	36" L x 36" W x 3" H
PSCPE36402	36" L x 40" W x 2" H
PSCPE36403	36" L x 40" W x 3" H
PSCPE36482	36" L x 48" W x 2" H
PSCPE36483	36" L x 48" W x 3" H
PSCPE38422	38" L x 42" W x 2" H
PSCPE38423	38" L x 42" W x 3" H
PSCPE38703	38" L x 70" W x 3" H
PSCPE40403	40" L x 40" W x 3" H
PSCPE45583	45" L x 58" W x 3" H
PSCPE48483	48" L x 48" W x 3" H
PSCPE48723	48" L x 72" W x 3" H
PSCPE52523	52" L x 52" W x 3" H
PSCPE56583	56" L x 58" W x 3" H



Self Piercing Screws



- White hex head
- IHWH slot
- Driving Speed: 2,500 rpm
- Axial Load: 13.6kg
- Zinc plated

SKU	Size	Pkg Qty
PSZIP8JW250	8mm x 1 1/2"	250
PSZIP8KW50	8mm x 2"	50
PSZIP8KW250	8mm x 2"	250



Self Piercing Screws



- White finished head
- Size: 8mm x 2"
- Zinc plated
- Package Quantity: 250

SKU
PSZIP8KWFH250



Self Piercing Screws



- Hex head
- IHWH slot
- Driving Speed: 2,500 rpm
- Axial Load: 13.6kg
- Zinc plated

SKU	Size	Pkg Qty	Hex Head
PSZIP7D100	7mm x 1/2"	100	1/4
PSZIP7D5000	7mm x 1/2"	5,000	1/4
PSZIP7D1000	7mm x 1/2"	1,000	1/4
PSZIP7D15000	7mm x 1/2"	15,000	1/4
PSZIP8D100	8mm x 1/2"	100	1/4
PSZIP8D1000	8mm x 1/2"	1,000	1/4
PSZIP8D12000	8mm x 1/2"	12,000	1/4
PSZIP8F100	8mm x 3/4"	100	1/4
PSZIP8F1000	8mm x 3/4"	1,000	1/4
PSZIP8F5000	8mm x 3/4"	5,000	1/4
PSZIP8F10000	8mm x 3/4"	10,000	1/4
PSZIP8G500	8mm x 1"	500	1/4
PSZIP8G1000	8mm x 1"	1,000	1/4
PSZIP8G5000	8mm x 1"	5,000	1/4
PSZIP8J250	8mm x 1 1/2"	250	1/4
PSZIP8J1000	8mm x 1 1/2"	1,000	1/4
PSZIP8J5000	8mm x 1 1/2"	5,000	1/4
PSZIP8K100	8mm x 2"	100	1/4
PSZIP8K250	8mm x 2"	250	1/4
PSZIP8K1000	8mm x 2"	1000	1/4
PSZIP10D1000	10mm x 1/2"	1,000	5/16
PSZIP10F100	10mm x 3/4"	100	5/16
PSZIP10F1000	10mm x 3/4"	1,000	5/16
PSZIP10F5000	10mm x 3/4"	5,000	5/16



Self Tapping Screws



- Hex head
- SAE C1018/C1022
- Self drilling screws, #2 point
- IHWH undercut
- Driving Speed: 2,500 rpm
- Axial Load: 30 lbs
- Test Plate Thickness: 1.6mm
- 3.0 sec max
- De-hydrogen embrittlement
- Zinc plated

SKU	Size	Pkg Qty
PSBIT8D100	8mm x 1/2"	100
PSBIT8D500	8mm x 1/2"	500
PSBIT8D1000	8mm x 1/2"	1,000
PSBIT8F100	8mm x 3/4"	100
PSBIT8F500	8mm x 3/4"	500
PSBIT8F1000	8mm x 3/4"	1,000
PSBIT10D100	10mm x 1/2"	100
PSBIT10D500	10mm x 1/2"	500
PSBIT10F100	10mm x 3/4"	100
PSBIT10F500	10mm x 3/4"	500
PSBIT10F1000	10mm x 3/4"	1,000
PSBIT10F5000	10mm x 3/4"	5,000
PSBIT10G100	10mm x 1"	100
PSBIT10G500	10mm x 1"	500



Hanger Straps



- Length: 50'
- 22 gauge
- Copper clad construction

SKU
PF100C22F50



Hanger Straps



- Galvanized steel construction

SKU	Length	Gauge
PF100G20F10	10'	20
PFPT22010	10'	22
PF100G24F10	10'	24
PFPT26010	10'	26
PF101G28F10	10'	28
PF100G24F50	50'	24
PF101G28F50	50'	28
PF100G24F100	100'	24
PF101G28F100	100'	28



Hanger Straps



- 24 gauge
- Steel construction

SKU	Length
PF100S24F10	10'
PF100S24F50	50'
PF100S24F100	100'

Hose Clamps



- Micro Series
- 1/4" high nickel grade stainless steel screw
- Band and housing are 5/16" high nickel grade stainless steel
- Constructed for small hose applications
- Easy to install in confined areas
- Made in the USA

SKU	Size
PFSSHC62602	1/4" - 5/8"
PFSSHC62606	5/16" - 7/8"

Hose Clamps



- Standard duty 5/16" hex head 410 stainless steel screws
- Band and housing are 1/2" design 201-301 stainless steel
- Made in the USA

SKU	Range
PFSSHC6706	3/8" - 7/8"
PFSSHC6708	7/16" - 1"
PFSSHC6710	1/2" - 1 1/16"
PFSSHC6712	1/2" - 1 1/4"
PFSSHC6716	3/4" - 1 1/2"
PFSSHC6720	3/4" - 1 3/4"
PFSSHC6736	7/8" - 2 3/8"
PFSSHC6724	1" - 2"
PFSSHC6740	1 1/8" - 3"
PFSSHC6728	1 5/16" - 2 1/4"
PFSSHC6744	1 5/16" - 3 1/4"
PFSSHC6732	1 9/16" - 2 1/2"
PFSSHC6748	1 5/8" - 3 1/2"
PFSSHC6752	1 7/8" - 3 3/4"
PFSSHC6756	2 1/8" - 4"
PFSSHC6764	2 5/8" - 4 1/2"
PFSSHC6772	3 1/8" - 5"
PFSSHC6780	3 5/8" - 5 1/2"
PFSSHC6799	4" - 7"
PFSSHC6788	4 1/4" - 6"
PFSSHC6796	4 3/4" - 6 1/2"



Hose Clamps



- Adjustable stainless steel hose clamp
- Band and housing are 9/16" design 201-301 stainless steel
- 5/16" hex head 410 stainless steel screws
- Made in USA

SKU	Range
PFSSHC6806	3/8" - 7/8"
PFSSHC6808	7/16" - 1"
PFSSHC6810	1/2" - 1 1/16"
PFSSHC6812	1/2" - 1 1/4"
PFSSHC6816	3/4" - 1 1/2"
PFSSHC6820	3/4" - 1 3/4"
PFSSHC6836	7/8" - 2 3/8"
PFSSHC6824	1" - 2"
PFSSHC6840	1 1/8" - 3"
PFSSHC6828	1 5/16" - 2 1/4"
PFSSHC6844	1 5/16" - 3 1/4"
PFSSHC6832	1 9/16" - 2 1/2"
PFSSHC6848	1 5/8" - 3 1/2"
PFSSHC6852	1 7/8" - 3 3/4"
PFSSHC6856	2 1/8" - 4"
PFSSHC63152	2 1/2" - 10"
PFSSHC63248	2 1/2" - 16"
PFSSHC6864	2 5/8" - 4 1/2"
PFSSHC6872	3 1/8" - 5"
PFSSHC6880	3 5/8" - 5 1/2"
PFSSHC68104	4" - 7"
PFSSHC6888	4 1/4" - 6"
PFSSHC6896	4 3/4" - 6 1/2"

Cut Resistant Gloves



- High performance synthetic
- Technical synthetic polyethylene fabric protects against abrasions and cuts
- EN Cut Level 3, ANSI Cut Level 2 Protection

SKU	Size
PSG12252	M
PSG12253	L
PSG12254	XL

Cut Resistant Gloves



- Seamless knit Kevlar® shell protects against abrasion and cuts
- Cut resistant rubber palm
- EN Cut Level 4, ANSI Cut Level 2 Protection

SKU	Size
PSG12152	M
PSG12153	L
PSG12154	XL



Disposable Gloves



- Non-sterile
- Beaded cuff
- Textured finish
- Latex free
- Powder free
- Material: Rubber/Nitrile
- Package Quantity: 50 pairs/box

SKU	Size
PSG14102PK	M
PSG14103PK	L
PSG14104PK	XL



Knit Gloves



- Industrial grade
- Seamless
- Textured latex palm for superior grip and chemical resistance
- Material: Cotton/Poly Blend

SKU	Size
PSG17552	M
PSG17553	L
PSG17554	XL



Disposable Gloves



- Non-sterile
- For industrial use only
- Powder free
- Material: Natural Rubber Latex
- Package Quantity: 50 pairs/box

SKU	Size
PSG14302PK	M
PSG14303PK	L
PSG14304PK	XL



Mechanics Gloves



- General duty
- One-piece palm of flexible synthetic suede
- Durable synthetic suede base layer does not shrink, stretch or harden
- Slip fit cuff with pull tab
- ID tag for jobsite recognition
- Internal knuckle padding

SKU	Size
RAP90101	M
RAP90102	L
RAP90103	XL



Driver Gloves



- Driver made in Gunn pattern with straight thumb
- C Grade cow grain leather with shirred elastic back
- Color/Finish: Cream

SKU	Size
PSG20152	M
PSG20153	L
PSG20154	XL



Mechanics Gloves



- Utility Plus
- All-purpose and abrasion-resistant
- Form-fit, washable and durable
- Neoprene cuff with gusset and Velcro closure adds wrist support, locks out cold, dirt and debris
- Neoprene knuckle padding
- Reinforced synthetic suede fingertips
- Terry cloth thumb to wipe away sweat and debris
- Non-slip palm and finger reinforcement provides extra grip

SKU	Size
RAP90201	M
RAP90202	L
RAP90203	XL



Jersey Gloves



- Material: 100% Cotton
- Size: Large
- Color/Finish: Brown

SKU
PSG16323



PVC Gloves



- Gauntlet style
- Extra Long Length: 14"
- Provides basic protection from oils, greases, acids and petrochemicals
- One size fits all
- Material: PVC

SKU
PSG18156

Tools & Installation Supplies

Gloves · Tapes · Cloths



Work Gloves



- 2 1/2" rubberized cuff
- Cow leather palms, fingertips and knuckle with cotton back
- Material: Cotton/Poly Blend Lining

SKU	Size	Pkg Qty
PSG20452	M	1 Pair
PSG20453	L	1 Pair
PSG20483PK	L	12 Pairs
PSG20454	XL	1 Pair
PSG20484PK	XL	12 Pairs

PTFE Pipe Thread Tapes



- High density
- 1.2 g/cm³ density
- Can be used on all types of threaded fittings for passage of potable and non-potable water, most chemicals, oxygen, liquid and natural gas, hydraulic lines, and high-pressure lines not exceeding 1 1/2" in diameter
- 100% PTFE
- Color/Finish: White

SKU	Size
PSMTD260	260" L x 1/2" W
PSMTD520	520" L x 1/2" W
PSMTTF520	520" L x 3/4" W

PTFE Pipe Thread Tapes



- Yellow gas
- 1.2 g/cm³ density
- Intended for application to male threads of metal pipe not exceeding 1 1/2"
- Used primarily in assemblies handling gasoline, naphtha, benzene, kerosene and petroleum oils to make joints tight against leakage
- Adaptable in some cases for application on pipe used with devices handling propane, butane or natural gas at a pressure not over 300 psi (2070kPa)
- 100% PTFE
- Color/Finish: Yellow

SKU	Size
PSGTTD260	260" L x 1/2" W
PSGTTD520	520" L x 1/2" W



PTFE Pipe Thread Tapes



- Standard density
- 0.35 g/cm³ density
- May be used on all types of threaded fittings for passage of potable and non-potable water, most chemicals, oxygen, gas, hydraulic and high-pressure lines to 1 1/2" in diameter
- Not for use on liquid fuels such as gasoline or diesel
- 100% PTFE
- Teflon
- Meets MIL-spec T-27730A

SKU	Size
PSTTD260	260" L x 1/2" W
PSTTF260	260" L x 3/4" W
PSTTD520	520" L x 1/2" W
PSTTF520	520" L x 3/4" W
PSTTG520	520" L x 1" W

Duct Tapes



- Size: 2" x 60 yd
- Tears evenly and shreds minimally
- Adheres well to irregular surfaces
- Won't twist or curl during application
- Made from high quality polyester (PET) cloth, polyethylene (PE) film, and a natural rubber, pressure sensitive adhesive
- Tested in accordance with UL-723, HUD and BOCA rated

SKU	Grade	Color/Finish
PSDTC260B	Premium	Black
PSDTC260S	Premium	Silver
PSDTU260S	Utility	Silver

Electrical Tapes



- For installation purposes and professional use
- Size: 3/4" x 60' x 7 mil
- Low voltage, Phase A
- Pressure-sensitive adhesive used to insulate electrical wires
- UL Listed E50292

SKU
PSXET

Open Mesh Abrasive Cloths



- Mesh Size: 18
- 180 grit aluminum oxide
- Waterproof
- Open mesh cloths last longer than sand cloth
- To clean, rinse with running water or tap on a hard surface

SKU	Size
PS0602	1 1/2" x 5 yd
PS0603	1 1/2" x 10 yd
PS0604	1 1/2" x 25 yd

Open Mesh Abrasive Cloths



- Mesh Size: 24
- 180 grit aluminum oxide
- Waterproof
- Super flexible
- Open mesh cloths last longer than sand cloth
- FLEX Mesh has a tough and ultra flexible small hole backing
- To clean, rinse with running water or tap on a hard surface

SKU	Size
PS0605	1 1/2" x 5 yd
PS0606	1 1/2" x 10 yd

Sand Cloths



- 120 grit aluminum oxide grain
- Use for cleaning, polishing, and deburring copper tubing, copper pipe, fitting, plastic pipe and other soft metal products
- Color/Finish: Brown

SKU	Size
PS0402	1 1/2" x 5 yd
PS0403	1 1/2" x 10 yd
PS0404	1 1/2" x 25 yd

Sand Cloths



- 120 grit aluminum oxide grain
- Waterproof
- Use for cleaning, polishing, and deburring copper tubing, copper pipe, fittings, plastic pipe and other soft metal products
- Color/Finish: Blue

SKU	Size
PS0503	1 1/2" x 10 yd
PS0504	1 1/2" x 25 yd

Non-Programmable Thermostats



- Conventional/Heat Pump
- Dual-Powered: Hardwired or battery
- Adjustable temperature set point limits
- Non-volatile memory retains user settings
- Easy access front battery door
- Separate O and B terminals
- Compressor short cycle protection
- Separate heating and cooling
- Large display with bright blue backlight

SKU	Stages
PSTSL11NP	1H/1C
PSTSL21NP	2H/1C

Programmable Thermostats



- Conventional/Heat Pump
- Dual-Powered: Hardwired or battery
- 5-2 day weekday/weekend programming
- Adjustable temperature set point limits
- Non-volatile memory retains user settings
- Filter check monitor
- Adaptive recovery mode
- Adjustable temperature differentials
- Meets California Title 24 Guidelines
- Large display with bright blue backlight

SKU	Stages
PSTSL11P52	1H/1C
PSTSL21P52	2H/1C

MERCURY THERMOSTAT RECYCLING PROGRAM

WE WANT YOUR MERCURY THERMOSTATS

Bring in all the mercury thermostats you remove from service or have sitting around your shop, and we will recycle them for you for free.

IT'S THAT EASY.



FERGUSON.COM



Expanding Foam



- Fills large or small holes, cracks, gaps and pipe penetrations
- Paintable
- Can be cut and sanded prior to painting
- CFC free
- Size: 12 oz

SKU

PFM90037



100% Silicone Caulk



- For interior/exterior use
- Excellent adhesion with lasting flexibility
- Cured sealant is mildew resistant
- VOC CARB non-chem curing (n.a) < 3.0%
- Size: 10.1 oz

SKU Color/Finish

PFC500ALU Aluminum

PFC500CLR Clear

PFC500WHT White



Acrylic Latex Caulk



- For interior/exterior use
- 15-year life expectancy
- Paintable with latex or oil based paints
- Soap and water clean up
- Cured sealant is mildew resistant
- Do not use for structural repairs
- Do not use below grade or underwater
- VOC CARB non-chem curing (n.a) < 1.5%
- Size: 10.1 oz
- Color/Finish: White

SKU

PFC100WHT



Latex Tub & Tile Caulk



- Fast curing, durable, mildew resistant
- Can also be used for kitchen and bath applications
- VOC CARB non-chem curing (n.a) < 1.5%
- Color/Finish: White

SKU Size

PFC301WHT 5.5 oz

PFC300WHT 10.1 oz



Siliconized Acrylic Latex Caulk



- For interior/exterior use
- 35-year life expectancy
- Paintable with latex or oil based paints
- Soap and water clean up
- VOC CARB non-chem curing (n.a) < 1.5%
- Size: 10.1 oz
- Color/Finish: White

SKU

PFC200WHT



RTV High Temperature Silicone Caulk



- Single component room temperature cure
- Continuous Operating Temperature Range: 75°F to 500°F (-60°C to 260°C)
- Excellent electrical insulation properties
- Excellent resistance to weather, ozone, UV and chemicals
- VOC CARB non-chem curing (n.a) < 3.0%
- Size: 10.1 oz
- Color/Finish: Red

SKU

PFC700RED



Siliconized Acrylic Caulk



- For kitchen/bath use
- Cured caulk is mildew resistant
- Soap and water clean up
- VOC CARB non-chem curing (n.a) < 1.5%

SKU Color/Finish Size

PFC401WHT White 5.5 oz

PFC600CLR Clear 10.1 oz



Caulk Guns



- Accepts industry standard 10.1 oz cartridge
- Length: 12"
- Barrel Diameter: 3 1/2"

SKU

PFCG



Caulk Guns



- Drip free
- Capacity: 12 oz
- Integrated plunger
- GSA approved

SKU

RAP11002

Caulk Guns



- Professional grade
- Capacity: 12 oz
- Steel frame
- Integrated plunger
- Smooth design for accurate application
- Ladder hook
- GSA approved

SKU

RAP11003

Gas Test Gauges



- 2" face
- Complete assembly includes gauge and air valve
- Dual scale (psi/kPa)
- Brass block and valve
- **Optional accessories:**
Gas test block: PFGTBA

SKU

SKU	Pressure Range	Tube Style
PFGG15K1**	0-15 psi	Diaphragm
PFGG30K	0-30 psi	Bourden
PFGG60K	0-60 psi	Bourden
PFGG100K	0-100 psi	Bourden

**Shown in 1/10 lb increments

Pressure Gauges



- Connection: 1/4" NPT brass lower mount
- Dual scale (psi/kPa)
- Steel case
- **For non-potable use**

SKU

SKU	Face Size	Pressure Range	Tube Style
PFPG15K1*	2"	0-15 psi	Bourden
PFPG30K	2"	0-30 psi	Bourden
PFPG60K	2"	0-60 psi	Bourden
PFPG100K	2"	0-100 psi	Bourden
PFPG160K	2"	0-160 psi	Bourden
PFPG200K	2"	0-200 psi	Bourden
PFPG300K	2"	0-300 psi	Bourden
PFPG5L	2 1/2"	0-5 psi	Diaphragm
PFPG30L	2 1/2"	0-30 psi	Bourden
PFPG60L	2 1/2"	0-60 psi	Bourden
PFPG100L	2 1/2"	0-100 psi	Bourden
PFPG160L	2 1/2"	0-160 psi	Bourden
PFPG200L	2 1/2"	0-200 psi	Bourden
PFPG300L	2 1/2"	0-300 psi	Bourden
PFPG100N	3 1/2"	0-100 psi	Bourden
PFPG200N	3 1/2"	0-200 psi	Bourden
PFPG300N	3 1/2"	0-300 psi	Bourden

*Shown in 1/10 lb increments

Pressure Gauges



- 2 1/2" face
- Connection: 1/4" NPT brass lower mount
- Dual scale (psi/kPa)
- Brass movement
- Steel case

SKU

Pressure Range

FNWLFG030L	0-30 psi
FNWLFG060L	0-60 psi
FNWLFG0100L	0-100 psi
FNWLFG0160L	0-160 psi
FNWLFG0200L	0-200 psi
FNWLFG0300L	0-300 psi

Pressure Gauges



- 2" face
- Operating Pressure: 0-100 psi
- Connection: 1/4" NPT brass lower mount
- Dual scale (psi/kPa)
- Bourden Tube Style
- Low lead compliant

SKU

Liquid Filled

PFXPG100K	No
PFXPGLF100K	Yes

Mechanical Pressure Gauges



- 4 1/2" face
- Connection: 1/4" NPT brass lower mount
- Dual scale (psi/kPa)
- Brass movement
- Steel case

SKU

Pressure Range

FNWG030R	0-30 psi
FNWG060R	0-60 psi
FNWG0100R	0-100 psi
FNWG0160R	0-160 psi
FNWG0200R	0-200 psi
FNWG0300R	0-300 psi

Water Test Gauges



- 2 1/2" face
- Operating Pressure: 0-300 psi
- Connection: 3/4" GHT brass
- Dual scale (psi/kPa)
- **For non-potable use**

SKU

With Memory Pointer

PFWG300L	No
PFWG1300L	Yes

Thermometers

FNW™



- Angle adjustable to 20 positions
- Green kerosene filled
- Rotating case
- Dual scale
- Size: 9"
- **Optional accessories:**
3 1/2" brass thermowell: FNWBTWN
3 1/2" brass thermowell (LF): FNWXBWTWN

SKU **Temperature Range**

FNW9S0120AT 0-120°F

FNW9S0160AT 0-160°F

FNW9S30240AT 30-240°F

Thermometers

FNW™



- Digital solar
- Adjustable angle
- Temperature Range: -50°F to 320°F
- Field selectable °F or °C display
- Updates every 6 seconds
- Dual switchable scale
- IP60 enclosure rating
- **Optional accessories:**
3 1/2" brass thermowell: FNWBTWN
3 1/2" brass thermowell (LF): FNWXBWTWN

SKU

FNWSDTHN

Extension Cords

RAPTOR™



- Heavy duty
- All weather
- 12/3 gauge
- Yellow
- Water resistant and flame retardant jacket will not absorb water that can corrode copper conductors or cause dangerous electrical shocks
- Superior flexibility and resists cracking in temperatures down to -40°F and up to 140°F (-40°C up to 60°C)
- Indicator light allows user to see when the power is on
- Meets OSHA requirements for extension cords and adapters for use on jobsites
- UL/cUL tested to both U.S. and Canadian standards

SKU **Cord Length**

RAP31203 25'

RAP31202 50'

RAP31201 100'

Extension Cords

RAPTOR™



- Extreme weather
- 12/3 gauge
- Blue/Orange
- SJEOW Heavy duty outdoor extension cord
- Oil resistant, water resistant, and flame retardant
- Superior flexibility and resists cracking to -58°F (-50°C)
- Meets OSHA requirements for extension cords and adapters for use on jobsites
- UL/cUL tested to both U.S. and Canadian standards

SKU **Cord Length**

RAP31207 50'

RAP31206 100'

Extension Cords

RAPTOR™



- Medium duty
- All weather
- 14/3 gauge
- Blue/Yellow
- Water resistant and flame retardant jacket will not absorb water that can corrode copper conductors or cause dangerous electrical shocks
- Superior flexibility and resists cracking in temperatures down to -40°F and up to 140°F (-40°C up to 60°C)
- Indicator light allows user to see when the power is on
- Meets OSHA requirements for extension cords and adapters for use on jobsites
- UL/cUL tested to both U.S. and Canadian standards

SKU **Cord Length**

RAP31402 50'

RAP31401 100'

Extension Cords

RAPTOR™



- Medium duty
- All weather
- 16/3 gauge
- Orange
- Water resistant and flame retardant jacket will not absorb water that can corrode copper conductors or cause dangerous electrical shocks
- Superior flexibility and resists cracking in temperatures down to -40°F and up to 140°F (-40°C up to 60°C)
- Indicator light allows user to see when the power is on
- Meets OSHA requirements for extension cords and adapters for use on jobsites
- UL/cUL tested to both U.S. and Canadian standards

SKU **Cord Length**

RAP31602 50'

RAP31601 100'



Twist-Lock Extension Cords



- Cord Length: 100'
- 12/3 gauge
- Oil resistant, water resistant, and flame retardant
- Superior flexibility and resists cracking in temperatures down to -40°F (-40°C)
- Meets OSHA requirements for extension cords and adapters for use on job sites
- UL/cUL tested to both U.S. and Canadian standards

SKU

RAP41201



Ground Fault Current Interrupters



- Cord Length: 3' in-line
- 12/3 gauge
- Water resistant and flame retardant jacket on cord
- Working temperature range is -31°F to +140°F
- Converts one outlet into additional GFCI protected outlets
- Indicator light allows user to see when the power is on
- Meets OSHA requirements for ground fault circuit interrupters for use on jobsites
- UL/cUL tested to both U.S. and Canadian standards

SKU

RAP32001



Power Block Adapters



- Triple Tap
- Cord Length: 2'
- 12/3 gauge
- Triple tap U-ground power block
- Water resistant, oil resistant, and flame retardant
- Superior flexibility at sub-freezing temperatures
- Meets OSHA requirements for extension cords and adapters for use on jobsites
- UL/cUL tested to both U.S. and Canadian standards

SKU

RAP31204



Power Supply Cords



- 16/3-wire grounded cord
- Tinned and stripped ends for easier connection
- For RAP33003 and RAP33002, accessories may include 3 wire nuts and Romex connectors
- UL/cUL tested to both U.S. and Canadian standards

SKU

Cord Length

Plug

RAP33003

3'

Angle

RAP33004

3'

Straight

RAP33005

6'

Angle

RAP33002

6'

Straight



Job Saws



- Demolition teeth cut on both push and pull strokes
- Sharpened tip punches through drywall easily
- Ideal for wood, plastic or drywall
- Comfort slip resistant handle

SKU

RAP15502



Hacksaws



- High-tension design
- Quick-change blade
- 90° and 45° cutting angles
- Comfort grip handles front and back

SKU

RAP15507



Mini Hacksaws



- Blade Length: 10"
- Cuts wood, plaster, steel and brass
- Ideal for tight places

SKU

RAP15508



Snips



- One-piece drop forged high carbon steel construction
- Cuts up to 20 gauge cold rolled steel or 24 gauge stainless steel
- Designed for cutting straight and wide curves to the left or right
- Cushion handle with smooth, comfortable bows for ease in use and safety
- GSA approved

SKU

RAP16512



Snips



- Long straight
- Professional quality
- Cuts up to 18 gauge cold rolled steel
- Also cuts aluminum and vinyl siding, screening and copper wire to 10 gauge
- Serrated cutting edges prevent materials from slipping during use
- Comfort, contoured grip
- GSA approved

SKU

RAP16501

Tools & Installation Supplies

Cutting Tools · Hand Tools

Snips



- Professional quality
- Cuts up to 16 gauge cold rolled steel or 20 gauge stainless steel
- Also cuts aluminum, vinyl siding, screening and other materials
- Serrated blade design for easy cutting
- Comfort grip handle
- Solid steel

SKU	Type
RAP16504	Straight
RAP16505	Right
RAP16506	Left

Snips



- Cuts up to 16 gauge cold rolled steel or 20 gauge stainless steel
- Ideal for straight cuts as well as tight curves, angles and circles
- Ergonomic bowed handles

SKU	Type
RAP16507	Offset Left
RAP16508	Offset Right

Utility Knives



- Quick change
- Easy turn dial for quick blade change
- Rubberized textured grip
- **Optional accessories:**
Replacement blades, 10 pack: RAP10501
Replacement blades, 100 pack: RAP10502

SKU
RAP10543

Utility Knives



- Steel
- Patent pending locking/folding mechanism
- Quick change blade design
- Precision machined anodized
- Aluminum handle

SKU
RAP10520

Utility Knife Blades



- Fits most standard utility knives
- Extra sharp treated blade
- 10 piece set

SKU
RAP10501

Utility Knife Blades



- Fits most standard utility knives
- Extra sharp treated blade
- 100 piece set

SKU
RAP10502

Screwdrivers



- Phillips Head
- Shaft runs length of tool
- Contoured, comfort grip handle with ribs for added grasp
- GSA approved

SKU	Length	Tip Size
RAP16009	4'	#2
RAP16007	6'	#1

Screwdrivers



- Flat Head
- Shaft runs length of tool
- Contoured, comfort grip handle with ribs for added grasp
- GSA approved

SKU	Length	Tip Size
RAP16001	3"	1/8"
RAP16002	4"	3/16"
RAP16004	6"	1/4"
RAP16003	8"	5/16"

Screwdrivers



- 6-in-1
- Includes: 2 flat tips, 2 Phillips tips, 1/4" and 5/16" nut drivers
- Contoured, comfort grip handle with ribs for added grasp
- GSA approved

SKU
RAP16012

Screwdrivers



- 19-in-1
- Includes: 3 flat, 3 star, 5 Phillips, 3 hex tips and 4 nut drivers
- Pivoting ratchet drive
- Screw top cap with bit storage
- Contoured comfort grip handle
- GSA approved

SKU
RAP16013

Screwdriver Sets

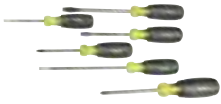

- 6 Piece Set
- Flat tips included: 3/16" x 3", 3/16" x 6", 1/4" x 4", 5/16" x 6"
- Phillips tips included: #1 x 3", #2 x 4"
- Vinyl grip
- Durable alloy steel, precision formed tips to ensure a more secure fit
- Chrome-plated shaft for corrosion resistance
- GSA approved

SKU

RAP16014

Nut Drivers



- Magnetic Tip
- 3 Piece Set
- Includes: 1/4", 5/16" and 3/8" tips
- Comfortable, rubber vinyl grip
- Size markings on each grip for quick identification
- GSA approved

SKU

RAP14560PK

Nut Drivers



- Hollow Shaft
- Comfortable, color coded rubber vinyl grips
- Size markings on each grip for quick identification
- Shaft Length: Standard
- GSA approved

SKU

Size

RAP14503 1/4"

RAP14504 5/16"

RAP14506 3/8"

RAP14507 7/16"

RAP14508 1/2"

Hex Key Sets



- 12 Piece SAE Set
- Includes Key Sizes: 1/16", 5/64", 5/32", 3/16", 3/32", 7/32", 7/64", 1/4", 1/8", 5/16", 9/64" and 3/8"
- Snap set holder for secure storage
- Durable black finish
- GSA approved

SKU

RAP13002



Nut Drivers



- Hollow Shaft
- 7 Piece Set
- Includes: 3/16", 1/4", 5/16", 11/32", 3/8", 7/16" and 1/2" nut drivers
- Comfortable, color coded rubber vinyl grips
- Size markings on each grip for quick identification
- GSA approved

SKU

RAP14509

Hex Key Sets



- 9 Piece Folding Set
- Includes Key Sizes: 3/16", 1/8", 7/32", 7/64", 1/4", 3/32", 5/32", 5/64" and 9/64"
- Durable black finish
- GSA approved

SKU

RAP13003



Nut Drivers



- Magnetic Tip
- Comfortable, color coded rubber vinyl grips are easy on the hands
- GSA approved

SKU

Size

Length

RAP14550 1/4" Stubby

RAP14551 1/4" Standard

RAP14552 5/16" Stubby

RAP14553 5/16" Standard

Hex Key Sets



- 9 Piece Metric Set
- Includes Key Sizes: 1.5mm, 2mm, 2.5mm, 3mm, 4mm, 5mm, 6mm, 8mm and 10mm
- Snap set holder for secure storage
- Durable black finish
- GSA approved

SKU

RAP13004

Tools & Installation Supplies

Hand Tools

Adjustable Wrenches



- Unique jaw design precisely grips the flat sides of fasteners, avoiding the rounding of fastener corners
- Specially designed handle reduces overall weight by 10%
- Non-protruding moveable jaw end allows easier access to fastener in tight spaces
- 18 to 25% wider jaw opening increases useful range of fastener sizes and gives the advantages of economy, convenience and lighter weight
- Superwide 8" wrench opens to a full 1 1/2" jaw capacity
- GSA approved

SKU	Length	Jaw Capacity
RAP18008	4"	5/8"
RAP18007	6"	1"
RAP18006	8"	1 1/2"
RAP18011	10"	1 1/4"
RAP18010	12"	1 1/2"
RAP18009	15"	1 7/8"

Torque Wrenches



- No-Hub
- T-handle style tools color coded to match the correct no-hub coupling
- Torque setting designed to slip when coupling nut has reached proper setting
- Locking collar lets user tighten nut to specified torque setting in one direction or use as non-torqueing tool in both directions
- GSA approved

SKU	Size	Max Torque	Color/Finish
RAP18550	5/16"	60 in-lbs	Black
RAP18551	5/16"	80 in-lbs	Yellow
RAP18552	3/8"	80 in-lbs	Green

Torque Wrenches



- For standard duty no-hub couplings
- Measures torque on no-hub couplings to 60 in-lbs
- Ratchets when correct torque is achieved

SKU
RAP50145

Locking Pliers



- Length: 10"
- Jaw Capacity: 1 3/4"
- Curved jaw for increased pressure point
- Guarded release trigger
- Durable turn screw for increased pressure
- GSA approved

SKU
RAP11502

Pliers



- Tongue & Groove
- Right angle teeth grip in all directions
- Self locking jaw opening adjustment
- Long, cushioned handles for extra leverage
- GSA approved

SKU	Length	Jaw Capacity
RAP18001	10"	2"
RAP18002	12"	2 1/2"
RAP18003	16"	4"

Side Cut Pliers



- Length: 8"
- Ideal for cutting copper, brass, iron and steel wire
- Not for use on live wires
- Forged steel
- GSA approved

SKU
RAP18024

Hammers



- Fiberglass Claw
- 16 oz
- Computer designed for better balance
- Slip resistant grip
- High density fiberglass shock absorption handle with hollow core

SKU
RAP12501

Hammers



- Steel Claw
- 24 oz
- Computer designed for better balance
- Patented shock absorbing hickory plug
- Slip resistant grip

SKU
RAP12504

Hammers



- Dead Blow
- 3 lbs
- Will not damage to wood, tile, chrome, or soft metals like steel hammers
- Non-rebounding, non-sparking, shock-absorbant
- Rugged, uni-body heavy-duty construction

SKU
RAP12507



Hammers



- Engineer
- 4 lbs
- Extra large striking face
- Slip resistant grip
- High density fiberglass handle with overstrike shield

SKU

RAP12509



Hammers



- Ball Pein
- 32 oz
- Computer designed for better balance
- Slip resistant grip
- High density fiberglass handle

SKU

RAP12518



Hammers



- HVAC Setting
- 24 oz
- Single piece forged construction
- Balanced design
- Beveled face
- Textured non-slip, vinyl handle
- GSA approved

SKU

RAP12525



For more of the tools
you need, visit us at
RaptorTool.com.



Torpedo Levels



- Length: 8"
- Protective anodized corrosion resistant finish
- 4 large Earth magnets off superior holding power
- Vials can be viewed from all sides and are replaceable
- Features a 4-vial system that reads 90°, 45°, 30°, 0°
- Includes: Level, 2 replacement vials, bungee style cord to hold level in place on pipes and uneven surfaces

SKU

RAP14500



Tape Measures



- Rubber case
- 9' tape standout
- 1 1/4" wide blade with large numbers for easy readability
- High impact case
- Large top-forward blade lock for quick locking and unlocking
- Shock-absorbing blade return bumper
- Belt-clip for quick accessibility
- GSA approved

SKU

Length

RAP17007

25'

RAP17004

30'



Tape Measures



- Length: 25'
- 8' tape standout
- 1" wide blade with large numbers for easy readability
- High impact rubber palm grip
- Top-forward blade lock for quick locking and unlocking
- Triple riveted hook grabs on side or top
- Bottom stopper for controlled tape recoil
- Shock-absorbing blade return bumper
- Belt-clip for quick accessibility
- GSA approved

SKU

RAP17002



Tape Measures



- Stainless steel case for durability
- Length: 25'
- 8' tape standout
- 1" wide blade with large numbers for easy readability
- Top-forward blade snap lock
- Nylon coated blade
- Triple riveted end hook
- Belt-clip for quick accessibility

SKU

RAP17006



Anode Rods



- Provides additional protection for water heaters against rust and corrosion for a longer tank life
- Use KA-90 rods for smelly water applications

SKU	Size	Material
PSW12103	14"	Aluminum
PSW12104	29"	Aluminum
PSW12102	32"	Magnesium
PSW12101	45"	Zinc KA-90



Dip Tubes



- Universal dip tube

SKU	Size
PSW12503	45"
PSW12501	52"



Water Heater Drain Valves



- 3/4" threads
- Fits most residential heaters
- Size: 2"

SKU
PSW12509



T&P Relief Valves



- Setting: 150 psi @ 210°F
- 3/4" threads
- 150#
- Fits most residential and light commercial heaters
- With stainless steel spring
- Brass construction
- ASTM Approval

SKU
PSW12601



Thermal Expansion Tanks



- 3/4" SS MIP connection
- Diaphragm-type
- Designed for potable hot water systems
- Eliminates relief valve spills and hot water waste
- Controls pressure build up
- Extends water heater life
- Factory precharged expansion tank
- Steel construction

SKU	Capacity
PFXT5	2 gal
PFXT5I	2.1 gal
PFXT12	4.4 gal
PFXT12I	4.8 gal



Thermocouples



- For residential and light commercial applications
- 30 mV
- Comes with adapters for most standard configurations
- Primarily used in water heaters, forced air heating systems, floor and wall furnaces

SKU	Length
PSTC18	18"
PSTC24	24"
PSTC30	30"
PSTC36	36"



Use PROSELECT for all of your needs.

We offer:

- Competitive Pricing
- Special Orders
- Regional Quotation Centers
- Thousands of additional SKUs



Visit us Online:
PROSELECTPRODUCTS.COM



Find a Branch:
PROSELECTPRODUCTS.COM/
support/where-to-buy

PSFGW, PSRGW, PSRG78W, PSARGW Return Air Grilles

Face Velocity	FPM	300	400	500	600	700
14 x 12 AK0.85	cfm	255	340	425	510	595
	Ps	0.020	0.032	0.052	0.074	0.103
14 x 14 AK0.91	cfm	269	358	448	537	627
	Ps	0.020	0.032	0.052	0.072	0.100
14 x 16 AK	cfm	117	156	195	234	273
	Ps	0.020	0.032	0.052	0.076	0.108
14 x 20 AK 1.29	cfm	383	510	638	765	893
	Ps	0.020	0.032	0.052	0.072	0.100
14 x 24 AK 1.55	cfm	457	610	762	914	1067
	Ps	0.020	0.032	0.052	0.072	0.100
14 x 25 AK 1.58	cfm	474	632	790	948	1106
	Ps	0.020	0.032	0.052	0.072	0.100
14 x 30 AK 1.89	cfm	567	756	945	1134	1323
	Ps	0.016	0.032	0.048	0.072	0.096
16 x 6 AK.45	cfm	133	177	222	266	310
	Ps	0.020	0.032	0.052	0.076	0.104
16 x 8 AK.62	cfm	186	248	310	372	434
	Ps	0.020	0.032	0.052	0.076	0.104
16 x 10 AK.78	cfm	234	312	390	468	546
	Ps	0.020	0.032	0.053	0.076	0.104
16 x 12 AK.91	cfm	273	364	455	546	637
	Ps	0.020	0.032	0.053	0.074	0.103
16 x 16 AK 1.17	cfm	350	467	584	700	817
	Ps	0.020	0.032	0.052	0.072	0.100
16 x 20 AK 1.46	cfm	434	578	723	867	1012
	Ps	0.020	0.032	0.052	0.072	0.100
16 x 24 AK 1.73	cfm	519	692	865	1038	1211
	Ps	0.016	0.032	0.052	0.072	0.096
16 x 25 AK 1.81	cfm	541	722	902	1082	1263
	Ps	0.016	0.032	0.052	0.072	0.096
16 x 30 AK 2.18	cfm	654	872	1090	1308	1526
	Ps	0.016	0.032	0.048	0.068	0.096
18 x 4 AK.38	cfm	114	152	190	228	266
	Ps	0.020	0.032	0.053	0.074	0.103
18 x 6 AK.50	cfm	150	200	250	300	350
	Ps	0.020	0.032	0.052	0.072	0.102
18 x 8 AK.69	cfm	201	268	335	402	469
	Ps	0.020	0.032	0.053	0.074	0.102
18 x 12 AK0.96	cfm	288	384	480	576	672
	Ps	0.020	0.032	0.052	0.072	0.101
18 x 18 AK 1.48	cfm	440	587	734	880	1027
	Ps	0.020	0.032	0.052	0.072	0.100
18 x 24 AK 1.95	cfm	585	780	975	1170	1365
	Ps	0.016	0.032	0.048	0.072	0.096
18 x 30 AK2.54	cfm	762	1016	1270	1524	1778
	Ps	0.016	0.032	0.050	0.070	0.092

PSFGW, PSRGW, PSRG78W, PSARGW Return Air Grilles

Face Velocity	FPM	300	400	500	600	700
20 x 6 AK.56	cfm	168	224	280	336	392
	Ps	0.190	0.034	0.053	0.076	0.105
20 x 8 AK.87	cfm	261	348	435	522	609
	Ps	0.020	0.032	0.052	0.072	0.104
20 x 10 AK.93	cfm	275	366	458	549	641
	Ps	0.020	0.032	0.052	0.072	0.104
20 x 12 AK 1.11	cfm	328	437	546	655	764
	Ps	0.020	0.032	0.052	0.072	0.100
20 x 14 AK 1.28	cfm	382	510	637	764	892
	Ps	0.020	0.032	0.052	0.072	0.100
20 x 16 AK 1.46	cfm	433	578	722	866	1011
	Ps	0.020	0.032	0.052	0.072	0.100
20 x 20 AK 1.83	cfm	542	723	904	1084	1265
	Ps	0.016	0.032	0.052	0.072	0.096
20 x 24 AK 2.19	cfm	651	868	1085	1302	1519
	Ps	0.016	0.032	0.048	0.068	0.096
20 x 25 AK 2.25	cfm	674	898	1123	1347	1572
	Ps	0.016	0.032	0.048	0.068	0.096
20 x 30 AK 2.71	cfm	808	1078	1347	1616	1886
	Ps	0.016	0.032	0.048	0.064	0.092
20 x 40 AK 3.5	cfm	1050	1400	1750	2100	2450
	Ps	0.012	0.030	0.045	0.058	0.091
22 x 22 AK2.2	cfm	660	880	1100	1320	1540
	Ps	0.016	0.032	0.048	0.068	0.096
24 x 6 AK 0.67	cfm	199	265	332	398	464
	Ps	0.020	0.032	0.052	0.076	0.100
24 x 8 Ak.89	cfm	263	350	438	525	613
	Ps	0.020	0.032	0.052	0.076	0.100
24 x 10 Ak 1.12	cfm	328	437	547	656	765
	Ps	0.020	0.032	0.052	0.072	0.100
24 x 12 Ak 1.32	cfm	392	522	653	783	914
	Ps	0.020	0.032	0.052	0.072	0.100
24 x 14 Ak 1.53	cfm	457	609	762	914	1066
	Ps	0.020	0.032	0.052	0.072	0.100
24 x 16 AK 1.73	cfm	519	692	865	1038	1211
	Ps	0.016	0.032	0.052	0.072	0.096
24 x 18 AK 1.94	cfm	582	776	970	1164	1358
	Ps	0.016	0.032	0.048	0.072	0.096
24 x 20 AK 2.17	cfm	649	865	1081	1297	1513
	Ps	0.016	0.032	0.048	0.068	0.096
24 x 24 AK 2.59	cfm	777	1036	1295	1554	1813
	Ps	0.016	0.032	0.048	0.068	0.092
24 x 30 AK 3.23	cfm	969	1292	1615	1938	2261
	Ps	0.016	0.032	0.048	0.064	0.088
24 x 36 AK 3.91	cfm	1173	1564	1955	2346	2737
	Ps	0.015	0.031	0.045	0.060	0.090

PSFGW, PSRGW, PSRG78W, PSARGW
Return Air Grilles

Face Velocity	FPM	300	400	500	600	700
25 x 14 Ak 1.59	cfm	475	634	792	950	1109
	Ps	0.016	0.032	0.052	0.072	0.100
25 x 16 AK 1.80	cfm	540	720	900	1080	1260
	Ps	0.016	0.032	0.052	0.072	0.096
25 x 20 Ak 2.25	cfm	674	898	1123	1347	1572
	Ps	0.016	0.032	0.048	0.068	0.096
25 x 25 AK 2.81	cfm	843	1124	1405	1686	1967
	Ps	0.016	0.032	0.048	0.068	0.092
25 x 32 AK 3.62	cfm	1086	1448	1810	2172	2534
	Ps	0.016	0.030	0.046	0.062	0.086
30 x 6 AK.83	cfm	248	330	413	495	578
	Ps	0.020	0.032	0.052	0.076	0.100
30 x 8 AK 1.12	cfm	328	437	547	656	765
	Ps	0.020	0.032	0.052	0.072	0.100
30 x 10 AK 1.37	cfm	408	544	680	816	952
	Ps	0.020	0.032	0.052	0.072	0.100
30 x 12 AK 1.65	cfm	487	650	812	974	1137
	Ps	0.016	0.032	0.052	0.072	0.096
30 x 14 AK 1.91	cfm	569	758	948	1137	1327
	Ps	0.016	0.032	0.048	0.072	0.096
30 x 16 AK 2.16	cfm	645	860	1075	1290	1505
	Ps	0.016	0.032	0.048	0.068	0.096
30 x 18 AK 2.46	cfm	728	970	1213	1455	1698
	Ps	0.016	0.032	0.048	0.068	0.092
30 x 20 AK 2.71	cfm	808	1078	1347	1616	1886
	Ps	0.016	0.032	0.048	0.064	0.092
30 x 24 AK 3.22	cfm	965	1286	1608	1929	2251
	Ps	0.016	0.032	0.048	0.064	0.088
30 x 25 AK3.26	cfm	978	1304	1630	1956	2282
	Ps	0.017	0.031	0.048	0.064	0.087
30 x 30 AK3.96	cfm	1188	1584	1980	2376	2772
	Ps	0.015	0.030	0.045	0.060	0.090
32 x 25 AK3.41	cfm	1038	1384	1730	2076	2422
	Ps	0.016	0.031	0.048	0.063	0.086
36 x 10 AK1.64	cfm	492	656	820	984	1148
	Ps	0.017	0.032	0.050	0.070	0.098
36 x 12 AK 1.96	cfm	588	784	980	1176	1372
	Ps	0.016	0.030	0.046	0.065	0.095
36 x 14 AK2.3	cfm	690	920	1150	1380	1610
	Ps	0.016	0.032	0.048	0.068	0.092
36 x 24 AK 3.9	cfm	1170	1560	1950	2340	2730
	Ps	0.015	0.031	0.045	0.060	0.090
40 x 20 AK 3.6	cfm	1080	1440	1800	2160	2520
	Ps	0.016	0.030	0.045	0.062	0.085

PSRGW
Stamped Steel Return Air Grilles

Face Velocity	FPM	300	400	500	600	700
Pressure Loss		.020	.036	.052	.080	.108
6 x 6 Ak.12	CFM	36	48	60	72	84
8 x 4 Ak.09	CFM	27	36	45	54	63
8 x 6 Ak.21	CFM	63	84	105	126	147
8 x 8 Ak.33	CFM	99	132	165	198	231
8 x 14 Ak.69	CFM	207	276	345	414	483
10 x 4 Ak.15	CFM	45	60	75	90	105
10 x 6 Ak.30	CFM	90	120	150	180	210
10 x 8 Ak.45	CFM	135	180	225	270	315
10 x 10 Ak.6	CFM	180	240	300	360	420
10 x 14 Ak.9	CFM	270	360	450	540	630
10 x 20 Ak.1.35	CFM	405	540	675	810	945
10 x 24 Ak.1.65	CFM	495	660	825	990	1155
12 x 4 Ak.21	CFM	63	84	105	126	147
12 x 6 Ak.39	CFM	117	156	195	234	273
12 x 8 Ak.57	CFM	171	228	285	342	399
12 x 10 Ak.75	CFM	225	300	375	450	525
12 x 12 Ak.93	CFM	279	372	465	558	651
12 x 18 Ak.1.47	CFM	441	588	735	882	1029
12 x 20 Ak.1.65	CFM	495	660	825	990	1155
12 x 24 Ak.2.01	CFM	603	804	1005	1206	1407
14 x 4 Ak.27	CFM	81	108	135	162	189
14 x 6 Ak.48	CFM	144	192	240	288	336
14 x 8 Ak.69	CFM	207	276	345	414	483
14 x 10 Ak.9	CFM	270	360	450	540	630
14 x 12 Ak.1.11	CFM	333	444	555	666	777
14 x 14 Ak1.32	CFM	396	528	660	792	924
14 x 20 Ak.1.95	CFM	585	780	975	1170	1365
14 x 24 Ak.2.37	CFM	711	948	1185	1422	1659
14 x 25 Ak.2.475	CFM	743	990	1238	1485	1733
14 x 30 Ak3.0	CFM	900	1200	1500	1800	2100
16 x 6 Ak.57	CFM	171	228	285	342	399
16 x 8 Ak.81	CFM	243	324	405	486	567
16 x 10 Ak.1.05	CFM	315	420	525	630	735
16 x 12 Ak1.29	CFM	387	516	645	774	903
16 x 16 Ak.1.77	CFM	531	708	885	1062	1239
16 x 20 Ak.2.25	CFM	675	900	1125	1350	1575
16 x 24 Ak.2.73	CFM	819	1092	1365	1638	1911
16 x 25 Ak.2.73	CFM	855	1140	1425	1710	1995
18 x 4 Ak.39	CFM	117	156	195	234	273
18 x 6 Ak.2.73	CFM	198	264	330	396	462
18 x 8 Ak.2.73	CFM	279	372	465	558	651
18 x 12 Ak.2.73	CFM	441	588	735	882	1029
18 x 18 Ak.2.73	CFM	684	912	1140	1368	1596
18 x 24 Ak.3.09	CFM	927	1236	1545	1854	2163
18 x 30 Ak.3.9	CFM	1170	1560	1950	2340	2730
20 x 8 Ak.2.73	CFM	315	420	525	630	735
20 x 10 Ak.2.73	CFM	405	540	675	810	945
20 x 12 Ak.2.73	CFM	495	660	825	990	1155
20 x 14 Ak.2.73	CFM	585	780	975	1170	1365
20 x 16 Ak.2.73	CFM	675	900	1125	1350	1575
20 x 20 Ak.2.73	CFM	855	1140	1425	1710	1995
20 x 24 Ak.2.73	CFM	1035	1380	1725	2070	2415
20 x 25 Ak.2.73	CFM	1080	1440	1800	2160	2520
20 x 30 Ak.2.73	CFM	1305	1740	2175	2610	3045
24 x 6 Ak.2.73	CFM	279	372	465	558	651
24 x 8 Ak.2.73	CFM	387	516	645	774	903

PSRGW

Stamped Steel Return Air Grilles

Face Velocity	FPM	300	400	500	600	700
Pressure Loss		.020	.036	.052	.080	.108
24 x 10 Ak.2.73	CFM	495	660	825	990	1155
24 x 12 Ak.2.73	CFM	603	804	1005	1206	1407
24 x 14 Ak.2.73	CFM	711	948	1185	1422	1659
24 x 16 Ak.2.73	CFM	819	1092	1365	1638	1911
24 x 18 Ak.2.73	CFM	927	1236	1545	1854	2163
24 x 20 Ak.2.73	CFM	1035	1380	1725	2070	2415
24 x 24 Ak.2.73	CFM	1251	1668	2085	2502	2919
24 x 30 Ak.2.73	CFM	1575	2100	2625	3150	3675
25 x 20 Ak.2.73	CFM	1080	1440	1800	2160	2520
30 x 6 Ak.2.73	CFM	360	480	600	720	840
30 x 8 Ak.2.73	CFM	495	660	825	990	1155
30 x 10 Ak.2.73	CFM	630	840	1050	1260	1470
30 x 12 Ak.2.73	CFM	765	1020	1275	1530	1785
30 x 14 Ak.2.73	CFM	900	1200	1500	1800	2100
30 x 16 Ak.2.73	CFM	1035	1380	1725	2070	2415
30 x 20 Ak.2.73	CFM	1305	1740	2175	2610	3045
30 x 30 Ak.2.73	CFM	1980	2640	3300	3960	4620
36 x 14 Ak.3.63	CFM	1089	1452	1815	2178	2541

PSRG3W

Stamped Steel Return Grilles, 1/3" Fin, 5/16" Turnback

Face Velocity	FPM	300	400	500	600	700
6 X 6 Ak.169	cfm	51	68	85	101	118
	Ps	0.012	0.020	0.028	0.040	0.056
8 X 8 Ak.300	cfm	90	120	150	180	210
	Ps	0.012	0.020	0.028	0.040	0.056
10 X 4 Ak.19	cfm	57	76	95	114	133
	Ps	0.012	0.020	0.028	0.040	0.056
10 x 6 AK.29	cfm	86	114	143	171	200
	Ps	0.012	0.020	0.028	0.040	0.056
10 X 10 Ak.491	cfm	147	196	246	295	344
	Ps	0.012	0.020	0.028	0.040	0.056
10 X 20 Ak.96	cfm	288	384	480	576	672
	Ps	0.010	0.018	0.029	0.041	0.056
10 X 24 AK1.15	cfm	345	460	575	690	805
	Ps	0.010	0.018	0.029	0.041	0.056
12 X 4 Ak.238	cfm	71	95	119	143	167
	Ps	0.012	0.020	0.028	0.040	0.056
12 x 6 AK.341	cfm	102	136	170	204	238
	Ps	0.012	0.020	0.028	0.040	0.056
12 X 8 AK.452	cfm	135	180	226	271	316
	Ps	0.012	0.020	0.028	0.040	0.056
12 X 10 Ak.570	cfm	171	228	285	342	399
	Ps	0.012	0.020	0.028	0.040	0.056
12 x 12 AK.695	cfm	206	274	343	411	480
	Ps	0.012	0.020	0.028	0.044	0.056
12 X 24 Ak1.389	cfm	417	556	695	833	972
	Ps	0.012	0.020	0.028	0.040	0.056
14 x 6 AK.399	cfm	119	159	199	238	278
	Ps	0.012	0.020	0.028	0.044	0.056
14 x 8 AK.534	cfm	159	212	266	319	372
	Ps	0.012	0.020	0.028	0.040	0.056
14 X 10 Ak.679	cfm	204	272	340	407	475
	Ps	0.012	0.020	0.028	0.040	0.056
14 x 14 AK.94	cfm	281	374	468	561	655
	Ps	0.012	0.016	0.028	0.044	0.056
14 X 20 Ak1.340	cfm	402	536	670	804	938
	Ps	0.012	0.016	0.028	0.040	0.056
14 X 24 Ak1.625	cfm	488	650	813	975	1138
	Ps	0.012	0.016	0.028	0.044	0.056
14 X 25 Ak1.715	cfm	515	686	858	1029	1201
	Ps	0.012	0.016	0.028	0.044	0.057
16 X 8 Ak.617	cfm	185	247	309	370	432
	Ps	0.012	0.016	0.028	0.040	0.056
16 X 10 Ak.764	cfm	229	306	382	458	535
	Ps	0.012	0.016	0.028	0.040	0.056
16 X 16 Ak1.230	cfm	369	492	615	738	861
	Ps	0.012	0.016	0.028	0.040	0.056
16 X 20 Ak1.522	cfm	457	609	761	913	1065
	Ps	0.012	0.016	0.028	0.044	0.060
16 X 24 Ak1.85	cfm	555	740	925	1110	1295
	Ps	0.010	0.018	0.028	0.041	0.057
16 X 25 Ak1.932	cfm	580	773	966	1159	1352
	Ps	0.012	0.016	0.028	0.040	0.056
18 X 8 Ak.695	cfm	209	278	348	417	487
	Ps	0.012	0.020	0.028	0.040	0.056
18 X 12 Ak1.04	cfm	312	416	520	624	728
	Ps	0.012	0.016	0.028	0.044	0.056

PSRG3W

Stamped Steel Return Air Grilles, 1/3" Fin, 5/16" Turnback

Face Velocity	FPM	300	400	500	600	700
18 X 18 Ak1.562	cfm	469	625	781	937	1093
	Ps	0.012	0.020	0.028	0.040	0.056
20 X 6 Ak.58	cfm	174	232	290	348	406
	Ps	0.012	0.020	0.028	0.040	0.056
20 X 8 Ak.760	cfm	228	304	380	456	532
	Ps	0.012	0.016	0.028	0.040	0.056
20 X 10 AK.956	cfm	285	380	476	571	666
	Ps	0.012	0.016	0.028	0.040	0.056
20 X 12 Ak1.15	cfm	345	460	575	690	805
	Ps	0.012	0.020	0.028	0.040	0.056
20 X 14 Ak1.30	cfm	390	520	650	780	910
	Ps	0.012	0.020	0.028	0.040	0.056
20 X 16 Ak1.543	cfm	463	617	772	926	1080
	Ps	0.012	0.016	0.028	0.040	0.056
20 X 18 Ak1.73	cfm	519	692	865	1038	1211
	Ps	0.012	0.016	0.028	0.044	0.056
20 x 20 AK 1.923	cfm	576	768	961	1153	1345
	Ps	0.012	0.016	0.028	0.044	0.060
20 X 24 Ak2.322	cfm	697	929	1161	1393	1625
	Ps	0.012	0.020	0.028	0.040	0.056
20 X 25 Ak2.416	cfm	725	966	1208	1450	1691
	Ps	0.012	0.020	0.028	0.044	0.056
24 x 6 AK.693	cfm	206	275	344	412	481
	Ps	0.012	0.020	0.028	0.044	0.056
24 x 8 Ak.92	cfm	275	366	458	550	641
	Ps	0.012	0.020	0.028	0.044	0.056
24 X 10 Ak1.16	cfm	348	464	580	696	812
	Ps	0.012	0.020	0.028	0.040	0.056
24 X 12 Ak1.37	cfm	411	548	685	822	959
	Ps	0.012	0.020	0.028	0.040	0.056
24 X 14 Ak1.63	cfm	489	652	815	978	1141
	Ps	0.012	0.016	0.028	0.040	0.056
24 X 16 Ak1.84	cfm	552	736	920	1104	1288
	Ps	0.010	0.018	0.029	0.042	0.057
24 X 20 Ak2.318	cfm	695	927	1159	1391	1623
	Ps	0.012	0.020	0.028	0.040	0.056
24 X 24 Ak2.78	cfm	834	1112	1390	1668	1946
	Ps	0.012	0.020	0.028	0.040	0.056
24 X 30 Ak3.492	cfm	1048	1397	1746	2095	2444
	Ps	0.012	0.020	0.028	0.040	0.056
25 x 20 Ak 2.413	cfm	723	964	1205	1445	1686
	Ps	0.012	0.020	0.028	0.044	0.060
30 x 6 AK.862	cfm	257	343	429	514	600
	Ps	0.012	0.020	0.028	0.040	0.056
30 x 8 AK 1.153	cfm	344	458	573	688	802
	Ps	0.012	0.020	0.028	0.040	0.056
30 X 10 Ak1.42	cfm	426	568	710	852	994
	Ps	0.012	0.020	0.028	0.040	0.056
30 X 12 Ak1.74	cfm	522	696	870	1044	1218
	Ps	0.012	0.016	0.028	0.040	0.056
30 X 14 Ak2.027	cfm	608	811	1014	1216	1419
	Ps	0.012	0.020	0.028	0.040	0.056
36 X 8 Ak1.38	cfm	414	552	690	828	966
	Ps	0.010	0.018	0.029	0.041	0.056

Velocity measured 1" from face
PSFG3W: test without filter.

PSFG3W

Stamped Steel Return Air Filter Grilles, 1/3" Fin

Face Velocity	FPM	300	400	500	600	700	
Pressure Loss		0.012	0.016	0.028	0.040	0.056	
12 x 12	Ak.686	CFM	40363	275	343	412	481
14 x 6	Ak.399	CFM	119	159	199	238	278
14 x 14	Ak.935	CFM	55012	374	468	561	655
14 x 20	Ak.1.338	CFM	401	535	669	803	937
14 x 24	Ak.1.625	CFM	488	650	813	975	1138
14 x 25	Ak.1.715	CFM	515	686	858	1029	1201
16 x 16	Ak.1.230	CFM	369	492	615	738	861
16 x 20	Ak.1.522	CFM	457	609	761	913	1065
16 x 25	Ak.1.932	CFM	580	773	966	1159	1352
18 x 18	Ak.1.562	CFM	469	625	781	937	1093
20 x 12	Ak.146	CFM	67406	459	573	688	802
20 x 14	Ak.1.340	CFM	402	536	670	804	938
20 x 16	Ak.1.543	CFM	463	617	772	926	1080
20 x 20	Ak.1.913	CFM	112478	765	956	1148	1339
20 x 25	Ak.2.416	CFM	725	966	1208	1450	1691
24 x 12	Ak.1.389	CFM	417	556	695	833	972
24 x 24	Ak.2.787	CFM	836	1115	1394	1672	1951
25 x 20	Ak.2.392	CFM	140648	957	1196	1435	1674
30 x 14	Ak.2.027	CFM	608	811	1014	1216	1419

Tested without filter

PSFBFG2W Fixed Bar Filter Grilles

Face Velocity	FPM	300	400	500	600	700	800	900	1000
Press Loss		0.012	0.02	0.032	0.044	0.06	0.08	0.095	0.116
10 x 10 Ak.46	cfm	138	184	230	276	322	368	414	460
12 x 12 Ak.68	cfm	198	264	331	397	463	529	595	661
14 x 14 Ak.94	cfm	276	368	460	552	644	736	828	920
14 x 20 Ak1.35	cfm	372.6	496.8	621	745.2	869.4	993.6	1117.8	1242
14 x 24 Ak1.60	cfm	474	632	790	948	1106	1264	1422	1580
14 x 25 Ak1.35	cfm	513	684	855	1026	1197	1368	1539	1710
14 x 30 Ak.1.18	cfm	624	832	1040	1249	1457	1665	1873	2081
16 x 16 Ak1.21	cfm	360	480	600	720	840	960	1080	1200
16 x 25 Ak1.96	cfm	588	784	980	1176	1372	1568	1764	1960
18 x 16 Ak1.4	cfm	420	560	700	840	980	1120	1260	1400
18 x 18 Ak1.55	cfm	460	613	766	919	1072	1226	1379	1532
20 x 10 Ak.94	cfm	276	388	502	613	725	838	949	1061
20 x 12 Ak1.14	cfm	336	448	561	673	785	897	1009	1121
20 x 14 Ak1.33	cfm	396	528	660	792	924	1056	1188	1320
20 x 16 Ak1.53	cfm	453	604	755	906	1057	1208	1359	1510
20 x 20 Ak1.92	cfm	571	761	951	1141	1331	1522	1712	1902
20 x 25 Ak2.41	cfm	723	964	1205	1446	1687	1928	2169	2410
20 x 30 Ak2.92	cfm	876	1168	1460	1752	2044	2336	2628	2920
24 x 10 Ak1.14	cfm	337	449	562	674	786	898	1011	1123
24 x 12 Ak1.37	cfm	406	541	676	811	946	1082	1217	1352
24 x 14 Ak1.60	cfm	480	640	800	960	1120	1280	1440	1600
24 x 16 Ak1.84	cfm	552	736	920	1104	1288	1472	1656	1840
24 x 20 Ak2.32	cfm	691	921	1151	1381	1611	1842	2072	2302
24 x 24 Ak2.80	cfm	835	1113	1392	1670	1948	2226	2505	2783
25 x 12 Ak1.46	cfm	438	584	730	876	1022	1168	1314	1460
25 x 14 Ak1.67	cfm	501	668	835	1002	1169	1336	1503	1670
25 x 16 Ak1.92	cfm	571	761	952	1142	1332	1522	1713	1903
25 x 20 Ak2.41	cfm	720	960	1200	1440	1680	1920	2160	2400
30 x 10 Ak1.43	cfm	429	572	715	858	1001	1144	1287	1430
30 x 12 Ak1.72	cfm	512	682	853	1023	1194	1364	1535	1705
30 x 14 Ak.1.18	cfm	606	808	1010	1212	1414	1616	1818	2020
30 x 16 Ak.1.98	cfm	718	958	1197	1437	1676	1916	2155	2395
30 x 18 Ak2.12	cfm	812	1083	1354	1625	1896	2167	2437	2708
30 x 20 Ak2.92	cfm	873	1164	1455	1746	2037	2328	2619	2910
30 x 24 Ak3.53	cfm	1058	1410	1763	2115	2468	2820	3173	3525
36 x 14 Ak2.42	cfm	723	964	1205	1446	1687	1928	2169	2410
40 x 20 Ak.3.62	cfm	1220	1627	2034	2440	2847	3254	3661	4067

PSFD Stamped Steel Floor Diffusers

Face Velocity	FPM	300	400	500	600	700	800	900	1000
Pressure Loss		0.004	0.008	0.016	0.024	0.028	0.040	0.052	0.060
2 x 10 AK.092	cfm	26	34	43	51	60	68	77	85
	Spread	3	4	5	6	7	8	9	10
	Throw	4	5	6	7	8	9	10	11
2 x 12 AK.110	cfm	32	43	54	65	76	86	97	108
	Spread	4	6	6	7	8	9	10	11
	Throw	5	6	7	8	9	10	11	12
2 x 14 AK.123	cfm	35	46	58	69	81	92	104	115
	Spread	4	6	7	7	8	10	11	12
	Throw	5	7	8	9	10	11	12	13
4 x 8 AK.150	cfm	39	52	65	78	91	104	117	130
	Spread	4	5	7	8	9	10	11	13
	Throw	6	7	8	10	11	12	13	14
4 x 10 AK.183	cfm	51	68	85	102	119	136	153	170
	Spread	5	6	7	8	10	11	13	15
	Throw	6	7	9	10	12	13	15	17
4 x 12 AK.210	cfm	62	83	104	125	146	166	187	208
	Spread	6	7	9	11	12	14	15	17
	Throw	5	6	8	9	10	11	13	14
4 x 14 AK.241	cfm	69	92	115	138	161	184	207	230
	Spread	7	8	10	11	13	16	17	19
	Throw	6	7	8	10	11	13	14	15
6 x 10 AK.247	cfm	72	96	120	144	168	192	216	240
	Spread	6	8	9	12	13	15	17	19
	Throw	5	7	8	10	11	13	14	15
6 x 12 AK.319	cfm	86	114	143	171	200	228	257	285
	Spread	7	9	10	13	15	17	19	22
	Throw	6	8	9	11	12	15	16	18
6 x 14 AK.350	cfm	101	134	168	201	235	268	302	335
	Spread	8	9	11	13	16	18	20	22
	Throw	6	8	10	12	13	15	17	18
8 x 14 AK0.406	cfm	122	162	203	244	284	325	365	406
	Spread	9	10	11	14	17	18	21	23
	Throw	7	8	10	12	13	15	17	19

Terminal Velocity of 50 fpm

PSBBR783W
Baseboard Registers, 1/3" Fin

Face Velocity		300	400	500	600	700	800	900	1000
Pressure Loss		0.008	0.012	0.016	0.024	0.032	0.044	0.052	0.064
10 x 6 Ak.252	cfm	75	100	125	150	175	200	225	250
	Throw	7	9	11	13	16	18	20	22
14 x 6 Ak.372	cfm	110	147	184	221	258	294	331	368
	Throw	8	11	13	15	17	20	22	24

Terminal Velocity of 75 fpm

PSRG78W
Return Air Grilles, 1/2" Fin, 7/8" Turnback

Face Velocity	FPM	300	400	500	600	700
14 x 8 Ak.54	cfm	156	208	260	312	364
	Ps	0.020	0.032	0.052	0.076	0.104
30 x 8 Ak.1.12	cfm	328	437	547	656	765
	Ps	0.020	0.032	0.052	0.072	0.100

Velocity measured 1" from face

PSDFD
Floor Diffusers Deluxe

Face Velocity	FPM	300	400	500	600	700	800	900	1000
Pressure Loss		0.008	0.012	0.016	0.024	0.032	0.040	0.048	0.060
2 x 10 Ak.106	cfm	27	36	45	54	63	72	81	90
	Spread	3	4	6	7	8	10	11	12
	Throw	2	3	4	5	5	6	7	8
2 x 12 Ak.114	cfm	34	45	56	67	78	90	101	112
	Spread	3	5	6	7	9	10	12	13
	Throw	2	4	4	5	6	7	8	8
2 x 14 Ak.142	cfm	40	53	67	80	93	106	120	133
	Spread	4	6	7	8	10	11	12	13
	Throw	3	4	5	5	6	7	8	9
4 x 10 Ak.182	cfm	52	70	87	104	122	139	157	174
	Spread	5	7	8	10	11	13	15	17
	Throw	3	4	5	6	7	8	9	10
4 x 12 Ak.218	cfm	65	86	108	127	148	170	191	212
	Spread	5	7	9	11	12	14	16	18
	Throw	3	4	5	6	8	9	10	11
4 x 14 Ak.257	cfm	76	101	127	152	177	202	228	253
	Spread	6	8	10	12	13	15	18	19
	Throw	4	5	6	7	8	9	11	12
6 x 10 Ak.282	cfm	82	109	136	163	190	218	245	272
	Spread	7	9	10	12	14	16	18	21
	Throw	4	5	6	7	9	10	11	13
6 x 12 Ak.347	cfm	101	135	169	203	237	270	304	338
	Spread	7	9	11	14	15	18	20	22
	Throw	5	6	7	9	10	11	12	14
6 x 14 Ak.396	cfm	117	156	196	235	274	313	352	391
	Spread	8	10	13	14	17	20	22	25
	Throw	5	6	7	9	10	12	13	15

Terminal Velocity of 50 fpm

PSTS
Stamped Steel Toe Space Grilles

Face Velocity	FPM	300	400	500	600	700	800	900	1000
Pressure Loss		0.004	0.008	0.016	0.024	0.028	0.04	0.052	0.06
2 x 10 Ak.092	cfm	26	34	43	51	60	68	77	85
	Spread	3	4	5	6	7	8	9	10
	Throw	4	5	6	7	8	9	10	11
2 x 12 Ak.110	cfm	32	43	54	65	76	86	97	108
	Spread	4	6	6	7	8	9	10	11
	Throw	5	6	7	8	9	10	11	12
2 x 14 Ak.123	cfm	35	46	58	69	81	92	104	115
	Spread	4	6	7	7	8	10	11	12
	Throw	5	7	8	9	10	11	12	13

Terminal Velocity of 50 fpm

PSFRD
Floor Registers

Face Velocity	FPM	300	400	500	600	700	800	900	1000
Pressure Loss		0.008	0.012	0.016	0.020	0.032	0.044	0.052	0.064
4 x 8 Ak.16	cfm	48	64	80	96	112	128	144	160
	Throw	4	6	8	10	12	13	15	16
4 x 10 Ak.20	cfm	60	80	100	120	140	160	180	200
	Throw	5	7	9	10	13	14	16	17
4 x 12 Ak.23	cfm	69	92	115	138	161	184	207	230
	Throw	5	8	10	11	13	15	17	18
4 x 14 Ak.28	cfm	84	112	140	168	196	224	252	280
	Throw	5	8	10	11	13	15	17	18
6 x 8 Ak.23	cfm	69	92	115	138	161	184	207	230
	Throw	5	8	10	11	13	15	17	18
6 x 10 Ak.33	cfm	99	132	165	198	231	264	297	330
	Throw	5	8	10	12	14	16	17	19
6 x 12 Ak.39	cfm	117	156	195	234	273	312	351	390
	Throw	6	8	11	13	14	17	18	20
6 x 14 Ak.46	cfm	138	184	230	276	322	368	414	460
	Throw	6	9	11	14	15	17	19	20
8 x 8 Ak.31	cfm	93	124	155	186	217	248	279	310
	Throw	5	8	10	12	14	16	17	19
8 x 12 Ak.54	cfm	162	216	270	324	378	432	486	540
	Throw	6	9	11	14	15	17	19	20
8 x 14 Ak.61	cfm	183	244	305	366	427	488	549	610
	Throw	7	10	12	16	17	18	21	22

Terminal Velocity of 50 fpm

PSFRGB Floor Return Air Grilles

Face Velocity	FPM	400	500	600	700	800	900	1000
4*10 Ak.265	cfm	106	133	159	186	212	239	265
	Pt	0.012	0.015	0.023	0.031	0.041	0.051	0.069
4*12 Ak.301	cfm	120	151	181	211	241	271	301
	Pt	0.012	0.015	0.022	0.031	0.040	0.051	0.069
4*14 Ak.337	cfm	135	169	202	236	270	303	337
	Pt	0.011	0.014	0.021	0.031	0.039	0.050	0.067
4*30 Ak.740	cfm	296	370	444	518	592	666	740
	Pt	0.008	0.014	0.017	0.027	0.036	0.043	0.054
6*10 Ak.370	cfm	148	185	222	259	296	333	370
	Pt	0.011	0.014	0.020	0.031	0.039	0.049	0.066
6*12 Ak.455	cfm	182	228	273	319	364	410	455
	Pt	0.010	0.014	0.020	0.030	0.039	0.048	0.063
6*14 Ak.540	cfm	216	270	324	378	432	486	540
	Pt	0.010	0.014	0.019	0.029	0.037	0.047	0.062
6*18 Ak.693	cfm	277	347	416	485	554	624	693
	Pt	0.009	0.014	0.017	0.027	0.036	0.045	0.059
6*20 Ak.740	cfm	296	370	444	518	592	666	740
	Pt	0.008	0.014	0.017	0.027	0.036	0.043	0.054
6*24 Ak.860	cfm	344	430	516	602	688	774	860
	Pt	0.007	0.013	0.017	0.024	0.033	0.041	0.052
6*30 Ak.1.05	cfm	420	525	630	735	840	945	1050
	Pt	0.007	0.013	0.017	0.023	0.032	0.041	0.048
8*10 Ak.505	cfm	202	253	303	354	404	455	505
	Pt	0.010	0.014	0.019	0.029	0.037	0.047	0.063
8*12 Ak.591	cfm	236	296	355	414	473	532	591
	Pt	0.010	0.014	0.018	0.028	0.037	0.046	0.061

PSFRGB Floor Return Air Grilles

Face Velocity	FPM	400	500	600	700	800	900	1000
8*20 Ak.923	cfm	369	462	554	646	738	831	923
	Pt	0.007	0.013	0.017	0.023	0.033	0.041	0.050
8*24 Ak.1.13	cfm	452	565	678	791	904	1017	1130
	Pt	0.007	0.013	0.017	0.023	0.031	0.040	0.048
8*30 Ak.1.37	cfm	548	685	822	959	1096	1233	1370
	Pt	0.007	0.012	0.017	0.023	0.029	0.036	0.046
10*10 Ak.658	cfm	263	329	395	461	526	592	658
	Pt	0.009	0.014	0.018	0.028	0.037	0.046	0.060
10*12 Ak.740	cfm	296	370	444	518	592	666	740
	Pt	0.008	0.014	0.017	0.027	0.036	0.043	0.054
10*14 Ak.802	cfm	321	401	481	561	642	722	802
	Pt	0.007	0.013	0.017	0.024	0.033	0.041	0.052
10*16 Ak.923	cfm	369	462	554	646	738	831	923
	Pt	0.007	0.013	0.017	0.023	0.033	0.041	0.050
10*20 Ak.1.22	cfm	488	610	732	854	976	1098	1220
	Pt	0.007	0.012	0.017	0.023	0.030	0.038	0.047
10*24 Ak.1.37	cfm	548	685	822	959	1096	1233	1370
	Pt	0.007	0.012	0.017	0.023	0.029	0.036	0.046
10*30 Ak.1.71	cfm	684	855	1026	1197	1368	1539	1710
	Pt	0.007	0.010	0.015	0.022	0.028	0.035	0.044
12*12 Ak.860	cfm	344	430	516	602	688	774	860
	Pt	0.007	0.013	0.017	0.024	0.033	0.041	0.052
12*14 Ak.980	cfm	392	490	588	686	784	882	980
	Pt	0.007	0.013	0.017	0.023	0.032	0.041	0.052
12*20 Ak.1.37	cfm	548	685	822	959	1096	1233	1370
	Pt	0.007	0.012	0.017	0.023	0.03	0.037	0.047
12*24 Ak.1.68	cfm	672	840	1008	1176	1344	1512	1680
	Pt	0.007	0.011	0.016	0.023	0.028	0.035	0.044
12*30 Ak.2.12	cfm	848	1060	1272	1484	1696	1908	2120
	Pt	0.007	0.010	0.015	0.021	0.026	0.033	0.040
14*14 Ak.1.18	cfm	472	590	708	826	944	1062	1180
	Pt	0.007	0.012	0.017	0.023	0.031	0.039	0.048
14*20 Ak.1.62	cfm	648	810	972	1134	1296	1458	1620
	Pt	0.007	0.011	0.016	0.023	0.028	0.035	0.045
14*24 Ak.1.96	cfm	784	980	1176	1372	1568	1764	1960
	Pt	0.007	0.010	0.015	0.021	0.026	0.033	0.040
14*30 Ak.2.47	cfm	988	1235	1482	1729	1976	2223	2470
	Pt	0.007	0.010	0.014	0.02	0.025	0.031	0.039
16*16 Ak.1.47	cfm	588	735	882	1029	1176	1323	1470
	Pt	0.007	0.012	0.016	0.023	0.29	0.036	0.045
16*20 Ak.1.85	cfm	740	925	1110	1295	1480	1665	1850
	Pt	0.007	0.010	0.015	0.022	0.027	0.034	0.041
16*30 Ak.2.65	cfm	1060	1325	1590	1855	2120	2385	2650
	Pt	0.006	0.010	0.014	0.019	0.024	0.030	0.038
20*20 Ak.2.36	cfm	944	1180	1416	1652	1888	2124	2360
	Pt	0.007	0.010	0.014	0.02	0.025	0.032	0.039
36*6 Ak.1.24	cfm	496	620	744	868	992	1116	1240
	Pt	0.007	0.012	0.017	0.023	0.030	0.037	0.047

Velocity measured 1" from face

PSBBD

Baseboard Diffusers

Face Velocity	FPM	300	400	500	600	700	800	900	1000
15" AK.162	cfm	48	64	80	96	112	128	144	161
	Ps	0.004	0.008	0.016	0.020	0.028	0.032	0.044	0.052
Throw	50	6	7.5	10	11	13	15.5	17	19.5
Spread	fpm	6	7	10.5	12.5	14.5	16	18	20
Throw	100	3	4	5	6	6.5	8	8.5	10
Spread	fpm	3	3.5	5	6	7	8	9	10
Throw	150	2	2.5	3	4	4.5	5	6	6.5
Spread	fpm	2	2.5	3.5	4	5	5.5	6	6.5
18" AK.271	cfm	79	105	131	157	183	210	237	263
	Ps	0.012	0.024	0.032	0.048	0.068	0.088	0.108	0.132
	Throw	6	7	8	10	11	12	15	16.5
Spread	5	7	7.5	9	10.5	12	14	16	

Terminal Velocity of 50 FPM

PSBRG3W

Baseboard Return Grilles, 1/3" Fin

Face Velocity	FPM	300	400	500	600	700
14 x 6 Ak.55	cfm	159	212	265	318	371
	Pt	0.013	0.024	0.036	0.052	0.067
30 x 6 Ak.1.16	cfm	336	448	560	672	784
	Pt	0.012	0.022	0.032	0.042	0.062

Velocity measured 1" from face

PSBBD

Baseboard Registers with Damper

Face Velocity	FPM	300	400	500	600	700
10 x 6 AK.38	cfm	113	160	210	240	280
	Pt	0.012	0.022	0.035	0.05	0.064
14 x 6 AK.55	cfm	159	212	265	318	371
	Pt	0.013	0.024	0.036	0.052	0.067

Terminal Velocity of 75 fpm

PSBBR

Baseboard Return Grilles

FPM	300	400	500	600	700	800	900	1000
Pressure Loss	0.012	0.024	0.032	0.048	0.068	0.088	0.108	0.132
18" AK.271	cfm	79	105	131	157	183	210	237
	Spread	5	7	7.5	9	10.5	12	14
Throw	6	7	8	10	11	12	15	

PSRG783W

Stamped Steel Baseboard Return Air Grilles, 1/3" Fin, 7/8" Turnback

Face Velocity	FPM	300	400	500	600	700
12 x 6 AK.47	cfm	138	184	230	276	322
	Pt	0.013	0.024	0.037	0.053	0.069
12 x 8 AK.627	cfm	188	250	313	376	439
	Pt	0.012	0.022	0.035	0.049	0.066
14 x 6 AK.55	cfm	159	212	265	318	371
	Pt	0.013	0.024	0.036	0.052	0.067
14 x 8 AK.75	cfm	217.5	290	362.5	435	507.5
	Pt	0.013	0.023	0.035	0.049	0.066
16 X 8 Ak.84	cfm	252	336	420	504	588
	Pt	0.012	0.020	0.032	0.044	0.064
20 X 8 Ak.92	cfm	276	368	460	552	644
	Pt	0.012	0.020	0.032	0.044	0.060
24 x 6 AK.95	cfm	276	368	460	552	644
	Pt	0.012	0.023	0.033	0.047	0.065
24 X 8 AK1.32	cfm	336	448	560	672	784
	Pt	0.010	0.020	0.030	0.042	0.058
24 x 12 AK1.9	cfm	570	760	950	1140	1330
	Pt	0.010	0.018	0.029	0.041	0.056
30 x 6 AK 1.16	cfm	336	448	560	672	784
	Pt	0.012	0.022	0.032	0.042	0.062
30 x 8 AK 1.51	cfm	451.5	602	752.5	900	1050
	Pt	0.012	0.020	0.031	0.042	0.059
30 X 10 AK1.93	cfm	579	772	965	1158	1351
	Pt	0.012	0.016	0.028	0.040	0.056
30 x 12 AK2.32	cfm	696	928	1160	1392	1624
	Pt	0.010	0.018	0.029	0.400	0.540
36 x 6 AK1.40	cfm	420	560	700	840	980
	Pt	0.012	0.021	0.031	0.043	0.059
36 x 8 AK1.86	cfm	558	744	930	1116	1302
	Pt	0.010	0.018	0.029	0.400	0.540

Velocity measured 1" from face

PSRCDW

Round Ceiling Diffusers

Face Velocity	FPM	300	400	500	600	700	800	900	1000
6" AK.141	cfm	41	55	69	83	97	110	124	138
	Throw	3	4	5	5	6	6	6	7
8" AK.232	cfm	69	92	115	138	161	184	207	230
	Throw	3	5	6	6	7	7	7	8
10" AK.352	cfm	104	138	173	207	242	276	311	345
	Throw	4	6	6	7	7	8	8	9
12" AK.513	cfm	152	202	253	303	354	404	455	505
	Throw	4	6	7	8	9	9	10	10
14" AK.637	cfm	191	254	318	381	445	508	572	635
	Throw	4	6	7	8	10	11	12	13

Terminal Velocity of 50 FPM

PSAASW Aluminum Sidewall Registers

Remark:

Air Pattern Obtained with Various Deflection Settings

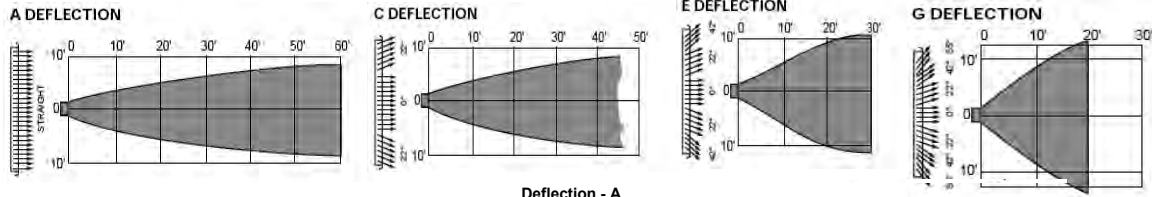

Deflection - A

Face Velocity	FPM	300	400	500	600	700	800	900	1000	1100	1200
Pressure Loss		0.008	0.012	0.016	0.024	0.032	0.040	0.052	0.064	0.076	0.092
6 x 6 Ak.19	cfm	57	71	89	106	124	142	159	177	195	212
	Throw	6	8	10	12	13	15	17	19	20	22
8 x 4 Ak.17	cfm	51	63	79	95	111	126	142	158	174	190
	Throw	5	7	9	10	13	14	16	17	19	20
8 x 6 Ak.26	cfm	78	97	121	145	169	194	218	242	266	290
	Throw	7	9	10	13	14	17	19	20	23	26
8 x 8 Ak.35	cfm	105	136	170	204	238	272	306	340	374	408
	Throw	8	10	12	15	18	20	23	25	28	30
10 x 4 Ak.21	cfm	63	80	100	120	140	160	180	200	220	240
	Throw	6	8	10	13	14	15	18	20	21	22
10 x 6 Ak.33	cfm	99	124	155	186	217	248	279	310	341	372
	Throw	8	10	13	14	17	20	22	24	27	28
10 x 8 Ak.43	cfm	129	167	209	251	293	334	376	418	460	502
	Throw	9	12	13	17	20	23	24	28	31	34
10 x 10 Ak.541	cfm	162	212	265	318	371	424	477	530	583	636
	Throw	11	13	15	19	22	23	27	31	33	37
12 x 4 Ak.26	cfm	78	96	121	145	169	193	217	241	265	289
	Throw	6	8	11	12	15	17	19	22	23	25
12 x 6 Ak.38	cfm	114	152	190	228	266	304	342	380	418	456
	Throw	9	11	14	15	18	22	23	27	29	31
12 x 8 Ak.53	cfm	159	206	257	308	360	411	463	514	565	617
	Throw	10	12	15	18	22	23	26	29	32	35
12 x 12 Ak.79	cfm	237	311	389	467	545	622	700	778	856	934
	Throw	14	17	19	23	27	30	34	38	41	45
14 x 4 Ak.30	cfm	90	113	142	170	198	226	255	283	311	340
	Throw	8	10	12	13	16	19	22	23	25	27
14 x 6 Ak.46	cfm	138	179	224	268	313	358	402	447	492	536
	Throw	11	13	15	17	20	23	26	29	31	35
14 x 8 Ak.60	cfm	180	236	296	355	414	473	532	591	650	709
	Throw	10	13	16	20	22	25	30	33	36	40
14 x 10 Ak.777	cfm	233	311	389	467	544	622	700	778	855	933
	Throw	13	16	18	22	24	27	32	35	38	42
14 x 14 Ak1.09	cfm	327	437	546	656	765	874	983	1093	1202	1311
	Throw	17	21	24	28	34	39	45	50	54	59
16 x 4 Ak.326	cfm	98	130	163	196	228	261	293	326	359	391
	Throw	9	11	12	14	17	20	23	25	27	30
16 x 6 Ak.53	cfm	159	212	265	318	371	424	477	530	583	636
	Throw	10	12	15	18	22	23	26	29	32	35
16 x 8 Ak.71	cfm	213	284	355	426	497	568	639	710	781	852
	Throw	12	15	18	22	24	27	32	35	38	42
16 x 10 Ak.883	cfm	265	353	442	530	618	706	795	883	971	1060
	Throw	15	19	22	27	30	33	40	43	47	52
16 x 16 Ak1.44	cfm	432	576	720	864	1008	1152	1296	1440	1584	1728
	Throw	24	30	36	44	49	55	65	71	77	85
18 x 6 Ak.597	cfm	179	239	299	359	418	478	538	598	657	717
	Throw	11	13	16	20	22	25	30	33	36	40

PSAASW
Aluminum Sidewall Registers

Face Velocity	FPM	300	400	500	600	700	800	900	1000	1100	1200
	Pressure Loss	0.008	0.012	0.016	0.024	0.032	0.040	0.052	0.064	0.076	0.092
18 x 8 Ak.80	cfm	240	320	400	480	560	640	720	800	880	960
	Throw	15	17	19	23	27	30	34	38	41	45
18 x 10 Ak.78	cfm	234	312	390	468	546	624	702	780	858	936
	Throw	14	17	19	23	27	30	34	38	41	45
18 x 12 Ak1.21	cfm	363	484	605	726	847	968	1089	1210	1331	1452
	Throw	22	26	29	36	42	47	53	59	64	70
18 x 18 Ak1.834	cfm	550	734	917	1100	1284	1467	1651	1834	2017	2201
	Throw	33	40	45	54	63	71	80	89	96	106
20 x 4 Ak.42	cfm	126	168	210	252	294	336	378	420	462	504
	Throw	8	9	10	12	15	16	18	21	22	24
20 x 6 Ak.651	cfm	195	260	326	391	456	521	586	651	716	781
	Throw	12	14	16	19	23	25	28	32	34	38
20 x 8 Ak.89	cfm	267	356	445	534	623	712	801	890	979	1068
	Throw	17	19	21	25	29	32	36	40	43	47
20 x 20 Ak2.28	cfm	683	910	1138	1365	1593	1820	2048	2275	2503	2730
	Throw	44	49	54	64	74	82	92	102	110	120
24 x 4 Ak.512	cfm	154	205	256	307	358	410	461	512	563	614
	Throw	10	11	12	15	17	19	22	24	26	29
24 x 6 Ak.80	cfm	62	320	400	480	560	640	720	800	880	960
	Throw	15	17	19	23	27	30	34	38	41	45
24 x 8 Ak1.07	cfm	321	428	535	642	749	856	963	1070	1177	1284
	Throw	20	23	26	31	36	38	42	46	49	55
24 x 12 Ak1.62	cfm	486	648	810	972	1134	1296	1458	1620	1782	1944
	Throw	30	35	40	47	55	58	64	70	74	84
24 x 14 Ak 1.91	cfm	573	764	955	1146	1337	1528	1719	1910	2101	2292
	Throw	36	41	45	55	65	72	81	91	98	108
28 x 6 Ak.93	cfm	279	372	465	558	651	744	837	930	1023	1116
	Throw	17	20	22	27	31	35	40	44	48	52
28 x 8 Ak1.26	cfm	378	504	630	756	882	1008	1134	1260	1386	1512
	Throw	24	27	30	36	42	47	53	60	64	71
30 x 6 Ak.999	cfm	300	400	500	599	699	799	899	999	1099	1199
	Throw	19	21	24	29	34	37	42	47	51	56
30 x 8 Ak1.35	cfm	405	540	675	810	945	1080	1215	1350	1485	1620
	Throw	25	29	32	39	46	51	57	64	69	76

Terminal Velocity of 75 fpm

Deflection - C

Face Velocity	FPM	300	400	500	600	700	800	900	1000	1100	1200
	Pressure Loss	0.008	0.012	0.016	0.024	0.032	0.040	0.052	0.064	0.076	0.092
6 x 6 Ak.143	cfm	43	57	72	86	100	114	129	143	157	172
	Throw	4	5	6	7	8	10	10	13	14	16
8 x 4 Ak.123	cfm	37	49	62	74	86	98	111	123	135	148
	Throw	3	4	5	6	7	8	9	11	12	13
8 x 6 Ak.203	cfm	61	81	102	122	142	162	183	203	223	244
	Throw	4	6	7	8	9	11	12	14	15	16
8 x 8 Ak.283	cfm	85	113	142	170	198	226	255	283	311	340
	Throw	5	8	10	11	13	15	16	19	21	23
10 x 4 Ak.163	cfm	49	65	82	98	114	130	147	163	179	196
	Throw	3	5	6	7	8	9	10	11	12	13
10 x 6 Ak.265	cfm	80	106	133	159	186	212	239	265	292	318
	Throw	4	6	7	9	10	11	13	15	16	17
10 x 8 Ak.363	cfm	109	145	182	218	254	290	327	363	399	436
	Throw	5	7	8	10	11	13	15	17	18	20
12 x 4 Ak.203	cfm	61	81	102	122	142	162	183	203	223	244
	Throw	3	4	5	6	7	8	9	10	11	12
12 x 6 Ak.323	cfm	69	92	115	138	161	184	207	230	253	276
	Throw	4	6	7	9	10	11	13	15	16	18
12 x 8 Ak.443	cfm	133	177	222	266	310	354	399	443	487	532
	Throw	5	8	10	12	13	15	17	20	22	23

PSAASW Aluminum Sidewall Registers

Face Velocity Pressure Loss	FPM	300	400	500	600	700	800	900	1000	1100	1200
		0.008	0.012	0.016	0.024	0.032	0.040	0.052	0.064	0.076	0.092
12 x 12 Ak.683	cfm	205	273	342	410	478	546	615	683	751	820
	Throw	8	12	15	18	20	23	26	30	32	35
10 x 10 Ak.463	cfm	139	185	232	278	324	370	417	463	509	556
	Throw	5	8	10	12	13	15	17	20	22	23
14 x 4 Ak.243	cfm	73	97	122	146	170	194	219	243	267	292
	Throw	4	6	7	8	9	10	12	13	15	16
14 x 6 Ak.383	cfm	115	153	192	230	268	306	345	383	421	460
	Throw	5	7	8	10	11	13	15	17	18	20
14 x 8 Ak.523	cfm	157	209	262	314	366	418	471	523	575	628
	Throw	5	8	10	12	13	15	17	20	22	23
14 x 10 Ak.663	cfm	199	265	332	398	464	530	597	663	729	796
	Throw	8	12	15	18	20	23	26	30	32	35
14 x 14 Ak.943	cfm	283	377	472	566	660	754	849	943	1037	1132
	Throw	9	14	17	20	24	27	30	35	38	41
16 x 4 Ak.283	cfm	85	113	142	170	198	226	255	283	311	340
	Throw	4	5	6	8	9	10	11	13	14	15
16 x 6 Ak.443	cfm	133	177	222	266	310	354	399	443	487	532
	Throw	5	7	9	11	12	14	15	18	19	21
16 x 8 Ak.603	cfm	181	241	302	362	422	482	543	603	663	724
	Throw	7	10	12	15	17	19	21	25	27	29
16 x 10 Ak.763	cfm	229	305	382	458	534	610	687	763	839	916
	Throw	8	12	15	18	20	23	26	30	32	35
16 x 16 Ak1.243	cfm	373	497	622	746	870	994	1119	1243	1367	1492
	Throw	13	20	25	29	34	38	43	49	54	58
18 x 6 Ak.503	cfm	151	201	252	302	352	402	453	503	553	604
	Throw	5	8	10	12	13	15	17	20	22	23
18 x 8 Ak.683	cfm	205	273	342	410	478	546	615	683	751	820
	Throw	7	10	12	15	17	19	21	25	27	29
18 x 10 Ak.863	cfm	259	345	432	518	604	690	777	863	949	1036
	Throw	9	13	16	19	22	24	27	32	35	37
18 x 12 Ak1.043	cfm	313	417	522	626	730	834	939	1043	1147	1252
	Throw	11	16	20	23	27	31	34	40	43	47
18 x 18 Ak1.583	cfm	475	633	792	950	1108	1266	1425	1583	1741	1900
	Throw	18	28	34	40	46	52	58	67	73	80
20 x 4 Ak.363	cfm	109	145	182	218	254	290	327	363	399	436
	Throw	5	7	8	10	11	13	15	17	18	20
20 x 6 Ak.563	cfm	169	225	282	338	394	450	507	563	619	676
	Throw	7	11	13	16	18	21	23	27	29	32
20 x 8 Ak.763	cfm	229	305	382	458	534	610	687	763	839	916
	Throw	9	14	17	20	24	27	30	35	38	41
20 x 20 Ak1.963	cfm	589	785	982	1178	1374	1570	1767	1963	2159	2356
	Throw	22	32	40	47	54	61	68	79	86	94
24 x 4 Ak.443	cfm	133	177	222	266	310	354	399	443	487	532
	Throw	5	8	10	12	13	15	17	20	22	23
24 x 6 Ak.683	cfm	205	273	342	410	478	546	615	683	751	820
	Throw	7	10	12	15	17	19	21	25	27	29
24 x 8 Ak.923	cfm	277	369	462	554	646	738	831	923	1015	1108
	Throw	11	16	20	23	27	31	34	40	43	47
24 x 12 Ak1.403	cfm	421	561	702	842	982	1122	1263	1403	1543	1684
	Throw	15	22	27	32	37	42	47	54	59	64
24 x 14 Ak1.643	cfm	493	657	822	986	1150	1314	1479	1643	1807	1972
	Throw	19	28	35	41	47	54	60	69	76	82
28 x 6 Ak.803	cfm	241	321	402	482	562	642	723	803	883	964
	Throw	9	14	17	20	24	27	30	35	38	41
28 x 8 Ak1.083	cfm	325	433	542	650	758	866	975	1083	1191	1300
	Throw	11	17	21	25	28	32	36	42	45	49
30 x 6 Ak.863	cfm	259	345	432	518	604	690	777	863	949	1036
	Throw	11	16	20	23	27	31	34	40	43	47
30 x 8 Ak1.163	cfm	349	465	582	698	814	930	1047	1163	1279	1396
	Throw	13	20	25	29	34	38	43	49	54	58

Terminal Velocity of 75 fpm

PSAASW
Aluminum Sidewall Registers

Deflection - E

Face Velocity	FPM	300	400	500	600	700	800	900	1000	1100	1200
Pressure Loss		0.008	0.012	0.016	0.024	0.032	0.040	0.052	0.064	0.076	0.092
6 x 6 Ak.17	cfm	51	64	80	95	111	127	143	159	175	191
	Throw	4	6	7	8	10	11	13	14	16	17
8 x 4 Ak.16	cfm	48	56	71	85	99	113	127	141	155	169
	Throw	4	5	7	8	9	10	12	14	15	16
8 x 6 Ak.23	cfm	69	87	109	130	152	174	195	217	239	260
	Throw	5	7	9	10	12	13	15	17	19	20
8 x 8 Ak.35	cfm	105	134	167	200	234	267	301	334	367	401
	Throw	6	8	10	12	14	15	17	20	21	23
10 x 4 Ak.19	cfm	57	72	90	107	125	143	161	179	197	215
	Throw	4	6	7	9	10	12	14	15	16	19
10 x 6 Ak.30	cfm	90	113	142	170	198	226	255	283	311	340
	Throw	6	8	10	12	13	15	17	19	20	23
10 x 8 Ak.39	cfm	117	151	189	227	265	302	340	378	416	454
	Throw	7	9	12	13	16	18	20	22	23	26
12 x 4 Ak.23	cfm	69	87	109	130	152	174	195	217	239	260
	Throw	5	7	9	10	12	14	15	18	19	20
12 x 6 Ak.35	cfm	105	137	171	205	239	274	308	342	376	410
	Throw	7	9	10	13	14	16	19	21	22	25
12 x 8 Ak.48	cfm	144	185	232	278	324	370	417	463	509	556
	Throw	8	10	12	13	16	19	21	23	25	27
12 x 12 Ak.72	cfm	216	281	351	421	491	562	632	702	772	842
	Throw	10	12	15	18	21	24	26	29	32	35
10 x 10 Ak.482	cfm	145	190	238	285	333	380	428	475	523	570
	Throw	8	10	12	15	16	20	22	24	28	30
14 x 4 Ak.27	cfm	81	102	128	153	179	204	230	255	281	306
	Throw	6	8	9	11	13	15	17	18	20	22
14 x 6 Ak.43	cfm	129	166	207	248	290	331	373	414	455	497
	Throw	8	10	12	14	17	19	21	23	25	28
14 x 8 Ak.55	cfm	165	213	266	319	372	426	479	532	585	638
	Throw	8	10	13	15	18	21	23	26	28	31
14 x 10 Ak.673	cfm	202	269	337	404	471	538	606	673	740	808
	Throw	10	12	16	18	22	26	28	32	34	38
14 x 14 Ak.918	cfm	275	367	459	551	643	734	826	918	1010	1102
	Throw	13	17	22	25	30	35	38	43	47	52
16 x 4 Ak.34	cfm	102	136	170	204	238	272	306	340	374	408
	Throw	5	6	8	9	11	13	14	16	17	19
16 x 6 Ak.48	cfm	144	192	240	288	336	384	432	480	528	576
	Throw	7	9	11	13	16	18	20	23	24	27
16 x 8 Ak.62	cfm	186	248	310	372	434	496	558	620	682	744
	Throw	9	11	15	17	20	24	26	29	32	35
16 x 10 Ak.76	cfm	228	304	380	456	532	608	684	760	836	912
	Throw	11	14	18	21	25	29	32	36	39	43
16 x 16 Ak1.18	cfm	354	472	590	708	826	944	1062	1180	1298	1416
	Throw	17	21	28	32	39	45	49	56	60	67
18 x 6 Ak.533	cfm	160	213	267	320	373	426	480	533	586	640
	Throw	8	10	13	15	17	20	22	25	27	30
18 x 8 Ak.69	cfm	207	276	345	414	483	552	621	690	759	828
	Throw	10	13	16	19	23	26	29	33	35	39
18 x 10 Ak.848	cfm	254	339	424	509	594	678	763	848	933	1018
	Throw	12	15	20	23	28	32	35	40	43	48
18 x 12 Ak1.005	cfm	302	402	503	603	704	804	905	1005	1106	1206
	Throw	15	18	24	27	33	38	42	48	51	57
18 x 18 Ak1.478	cfm	443	591	739	887	1035	1182	1330	1478	1626	1774
	Throw	22	27	35	40	48	56	62	70	75	83
20 x 4 Ak.41	cfm	123	164	205	246	287	328	369	410	451	492
	Throw	6	7	10	11	13	16	17	19	21	23
20 x 6 Ak.585	cfm	176	234	293	351	410	468	527	585	644	702
	Throw	8	9	12	14	17	20	22	24	26	29

PSAASW Aluminum Sidewall Registers

Face Velocity	FPM	300	400	500	600	700	800	900	1000	1100	1200
		Pressure Loss	0.008	0.012	0.016	0.024	0.032	0.040	0.052	0.064	0.076
20 x 8 Ak.76	cfm	228	304	380	456	532	608	684	760	836	912
	Throw	11	14	18	21	25	29	32	36	39	43
20 x 20 Ak.1.81	cfm	543	724	905	1086	1267	1448	1629	1810	1991	2172
	Throw	26	33	43	49	59	69	76	86	92	102
24 x 4 Ak.48	cfm	144	192	240	288	336	384	432	480	528	576
	Throw	7	9	11	13	16	18	20	23	24	27
24 x 6 Ak.69	cfm	207	276	345	414	483	552	621	690	759	828
	Throw	10	13	16	19	23	26	29	33	35	39
24 x 8 Ak.90	cfm	270	360	450	540	630	720	810	900	990	1080
	Throw	13	16	21	25	29	34	38	43	46	51
24 x 12 Ak.1.32	cfm	396	528	660	792	924	1056	1188	1320	1452	1584
	Throw	19	24	31	36	43	50	55	62	67	74
24 x 14 Ak.1.53	cfm	459	612	765	918	1071	1224	1377	1530	1683	1836
	Throw	22	28	36	42	50	58	64	72	78	86
28 x 6 Ak.795	cfm	239	318	398	477	557	636	716	795	875	954
	Throw	12	14	19	22	26	30	33	38	41	45
28 x 8 Ak.1.04	cfm	312	416	520	624	728	832	936	1040	1144	1248
	Throw	15	19	25	28	34	40	43	49	53	59
30 x 6 Ak.848	cfm	254	339	424	509	594	678	763	848	933	1018
	Throw	12	15	20	23	28	32	35	40	43	48
30 x 8 Ak.1.11	cfm	333	444	555	666	777	888	999	1110	1221	1332
	Throw	16	20	26	30	36	42	46	53	57	63

Terminal Velocity of 75 fpm

Deflection - G

Face Velocity	FPM	300	400	500	600	700	800	900	1000	1100	1200
		Pressure Loss	0.008	0.012	0.016	0.024	0.032	0.040	0.052	0.064	0.076
6 x 6 Ak.135	cfm	41	54	68	81	95	108	122	135	149	162
	Throw	2	3	4	4	6	6	7	7	8	9
8 x 4 Ak.12	cfm	36	48	60	72	84	96	108	120	132	144
	Throw	2	3	4	4	5	6	6	7	8	8
8 x 6 Ak.186	cfm	56	74	93	112	130	149	167	186	205	223
	Throw	3	4	5	6	8	8	9	10	11	12
8 x 8 Ak.255	cfm	77	102	128	153	179	204	230	255	281	306
	Throw	4	5	7	8	10	11	12	13	15	16
10 x 4 Ak.152	cfm	46	61	76	91	106	122	137	152	167	182
	Throw	2	3	4	5	6	7	7	8	9	10
10 x 6 Ak.238	cfm	71	95	119	143	167	190	214	238	262	286
	Throw	3	4	5	6	8	8	9	10	11	12
10 x 8 Ak.324	cfm	97	130	162	194	227	259	292	324	356	389
	Throw	3	4	6	7	8	9	10	11	12	13
12 x 4 Ak.186	cfm	56	74	93	112	130	149	167	186	205	223
	Throw	2	3	4	5	6	7	7	8	9	10
12 x 6 Ak.291	cfm	87	116	146	175	204	233	262	291	320	349
	Throw	3	4	5	6	7	8	9	9	11	12
12 x 8 Ak.393	cfm	118	157	197	236	275	314	354	393	432	472
	Throw	3	4	6	7	9	9	10	11	13	14
12 x 12 Ak.599	cfm	180	240	300	359	419	479	539	599	659	719
	Throw	6	8	11	12	15	17	18	20	23	24
10 x 10 Ak.41	cfm	123	164	205	246	287	328	369	410	451	492
	Throw	4	5	7	8	9	10	11	12	14	15
14 x 4 Ak.221	cfm	66	88	111	133	155	177	199	221	243	265
	Throw	3	3	5	6	7	8	8	9	10	11
14 x 6 Ak.342	cfm	103	137	171	205	239	274	308	342	376	410
	Throw	4	5	6	7	9	10	11	12	14	14
14 x 8 Ak.462	cfm	139	185	231	277	323	370	416	462	508	554
	Throw	4	5	7	8	10	11	12	13	15	16

PSAASW Aluminum Sidewall Registers

Face Velocity	FPM	300	400	500	600	700	800	900	1000	1100	1200
		Pressure Loss	0.008	0.012	0.016	0.024	0.032	0.040	0.052	0.064	0.076
14 x 10 Ak.582	cfm	175	233	291	349	407	466	524	582	640	698
	Throw	3	4	6	6	8	9	10	10	12	13
14 x 14 Ak.823	cfm	247	329	412	494	576	658	741	823	905	988
	Throw	5	7	9	11	13	14	16	17	20	21
16 x 4 Ak.255	cfm	77	102	128	153	179	204	230	255	281	306
	Throw	2	2	3	3	4	4	5	5	6	6
16 x 6 Ak.393	cfm	118	157	197	236	275	314	354	393	432	472
	Throw	4	5	8	9	11	12	13	14	16	17
16 x 8 Ak.53	cfm	159	212	265	318	371	424	477	530	583	636
	Throw	6	8	11	12	15	17	18	20	23	24
16 x 10 Ak.668	cfm	200	267	334	401	468	534	601	668	735	802
	Throw	7	8	12	13	17	18	20	22	25	27
16 x 16 Ak1.08	cfm	324	432	540	648	756	864	972	1080	1188	1296
	Throw	10	13	18	20	25	28	30	33	38	40
18 x 6 Ak.445	cfm	134	178	223	267	312	356	401	445	490	534
	Throw	5	6	9	10	13	14	15	16	19	20
18 x 8 Ak.599	cfm	180	240	300	359	419	479	539	599	659	719
	Throw	5	7	9	11	14	15	16	18	20	22
18 x 10 Ak.754	cfm	226	302	377	452	528	603	679	754	829	905
	Throw	8	10	14	16	20	21	23	25	29	31
18 x 12 Ak.91	cfm	273	364	455	546	637	728	819	910	1001	1092
	Throw	10	12	17	20	25	27	30	32	37	40
18 x 18 Ak1.37	cfm	411	548	685	822	959	1096	1233	1370	1507	1644
	Throw	16	20	27	31	39	43	47	51	59	62
20 x 4 Ak.324	cfm	97	130	162	194	227	259	292	324	356	389
	Throw	4	5	7	8	10	11	12	13	15	16
20 x 6 Ak.496	cfm	149	198	248	298	347	397	446	496	546	595
	Throw	5	7	9	11	14	15	16	18	20	22
20 x 8 Ak.668	cfm	200	267	334	401	468	534	601	668	735	802
	Throw	8	9	13	15	19	21	23	24	28	30
20 x 20 Ak1.7	cfm	510	680	850	1020	1190	1360	1530	1700	1870	2040
	Throw	21	26	37	42	53	58	63	68	79	84
24 x 4 Ak.393	cfm	118	157	197	236	275	314	354	393	432	472
	Throw	5	6	8	10	12	13	14	16	18	19
24 x 6 Ak.599	cfm	180	240	300	359	419	479	539	599	659	719
	Throw	7	9	12	14	17	19	21	22	26	27
24 x 8 Ak.806	cfm	242	322	403	484	564	645	725	806	887	967
	Throw	10	12	17	19	24	26	29	31	36	38
24 x 12 Ak1.22	cfm	366	488	610	732	854	976	1098	1220	1342	1464
	Throw	14	18	25	29	36	40	43	47	54	58
24 x 14 Ak1.45	cfm	426	568	710	852	994	1136	1278	1420	1562	1704
	Throw	18	22	31	36	45	49	53	58	67	71
28 x 6 Ak.703	cfm	211	281	352	422	492	562	633	703	773	844
	Throw	8	10	14	16	21	23	25	27	31	33
28 x 8 Ak.943	cfm	283	377	472	566	660	754	849	943	1037	1132
	Throw	12	15	21	24	29	32	35	38	44	47
30 x 6 Ak.754	cfm	226	302	377	452	528	603	679	754	829	905
	Throw	9	12	16	19	24	26	28	31	35	38
30 x 8 Ak1.012	cfm	304	405	506	607	708	810	911	1012	1113	1214
	Throw	12	16	22	25	31	34	37	40	47	50

Terminal Velocity of 75 fpm

PSA3W Aluminum Ceiling Diffusers 3-Way

Face Velocity	FPM	400	500	600	700	900	1100	1500
Pressure Loss		0.016	0.028	0.052	0.072	0.112	0.144	0.280
6"6 AK.14	cfm	52	65	78	91	117	143	195
	Throw L/S	4/3	5/4	5/4	6/5	7/6	8/7	11/8
8"8 AK.23	cfm	80	100	120	140	180	220	300
	Throw L/S	4/2	5/3	6/3	7/4	10/5	12/6	15/9
10"10 AK.30	cfm	116	145	174	203	261	319	435
	Throw L/S	6/3	8/4	9/5	10/5	12/7	14/8	18/10
12"12 AK.42	cfm	168	210	252	294	378	462	630
	Throw L/S	6/4	8/5	10/6	12/7	16/9	20/11	24/16

Terminal Velocity of 75 fpm

PSP3WW Plastic Sidewall/Ceiling Registers 3-Way

Face Velocity	FPM	300	400	500	600	700	800	900	1000
Pressure Loss		0.016	0.024	0.028	0.036	0.040	0.048	0.072	0.084
8 x 4 AK.212	cfm	60	80	100	120	140	160	180	200
	Throw L/S	2/1	2.5/1.5	3/1.5	3.5/2	4.5/2.5	5/3	6/3	6.5/4
10 x 6 AK.237	cfm	69	92	115	138	161	184	207	230
	Throw L/S	3/1.5	3/2	4/2	4.5/2.5	5/3	6.5/3.5	7/3.5	7.5/4.5
10 x 8 AK.255	cfm	74	98	123	147	172	196	221	245
	Throw L/S	3/2	4/2.5	4.5/3	5/3.5	6.5/3.5	7/4.5	8/5	9.5/5.5
12 x 6 AK.249	cfm	72	96	120	144	168	192	216	240
	Throw L/S	3.5/3.5	4/4	4.5/4.5	5.5/5.5	6/6	7.5/7.5	8/8	9/9
14 x 8 AK.412	cfm	120	160	200	240	280	320	360	400
	Throw L/S	4.5/3	6/4	6.5/4.5	7.5/5	8/5.5	9.5/6	10/6.5	10.5/7

Terminal Velocity of 75 fpm

PSA4W Aluminum Ceiling Diffusers 4-Way

Face Velocity	FPM	400	500	600	700	900	1100	1500
Pressure Loss		0.016	0.028	0.052	0.072	0.116	0.152	0.280
6"6 AK.14	cfm	52	65	78	91	117	143	195
	Throw	3	4	4	5	6	7	10
8"8 AK.23	cfm	80	100	120	140	180	220	300
	Throw	4	5	6	6	8	10	14
10"10 AK.30	cfm	116	145	174	203	261	319	435
	Throw	4	5	7	9	10	11	16
12"12 AK.42	cfm	168	210	252	294	378	462	630
	Throw	6	7	8	9	11	13	17
14"14 AK.61	cfm	244	305	366	427	549	671	915
	Throw	7	8	9	10	12	15	19

Terminal Velocity of 75 fpm

PSP4WW Plastic Sidewall/Ceiling Registers 4-Way

Face Velocity	FPM	300	400	500	600	700	800	900	1000
Pressure Loss		0.016	0.020	0.024	0.028	0.036	0.044	0.052	0.072
6 x 6 AK.256	cfm	77	102	128	154	179	205	230	256
	Throw	3	5	7	8	10	12	13	15
8 x 8 AK.335	cfm	101	134	168	201	235	268	302	335
	Throw	4	6	8	9	11	13	14	15
10x 10 AK.425	cfm	128	170	213	255	298	340	383	425
	Throw	4	7	9	10	11	14	15	16
12 x 12 AK.525	cfm	154	205	256	307	358	410	461	512
	Throw	5	7	9	10	12	14	15	16

Terminal Velocity of 75 fpm

PSP2WW Plastic Sidewall/Ceiling Registers 2-Way

Face Velocity	FPM	300	400	500	600	700	800	900	1000
Pressure Loss		0.016	0.024	0.028	0.036	0.040	0.048	0.052	0.064
6"6 AK.085	cfm	26	34	43	51	60	68	77	85
	Throw	4.0	6	7	9	10.0	12	13.0	15
8 x 4 AK.107	cfm	30	40	50	60	70	80	90	100
	Throw	2.5	3	3.5	4.5	5	5.5	6	7
10 x 8 AK.282	cfm	84	112	140	168	196	224	252	280
	Throw	6.5	8	10	12	13.5	16	18.5	20
12 x 6 AK.249	cfm	72	96	120	144	168	192	216	240
	Throw	6	8	10	11	13.5	15.5	18	19.5
14 x 6 AK.304	cfm	90	120	150	180	210	240	270	300
	Throw	7.5	9	12.5	14	16	18.5	20	22.5
14 x 8 AK.368	cfm	110	147	184	221	258	295	331	368
	Throw	9.0	11	12.0	14	15	16.0	17	20.0

Terminal Velocity of 75 fpm

PSPFBS, PSPFBR, PSCBSST, PSCBRST Ceiling Diffusers for T-Bar & Perforated Supply with Target Back

Neck Size	Inlet Velocity	300	400	500	600	700	800	900	1000
		Ps	-.01	-.02	-.03	-.04	-.05	-.06	-.08
6"	CFM	60	80	100	115	135	155	175	195
8"	CFM	105	140	175	210	245	280	315	350
10"	CFM	165	220	270	325	380	435	490	545
12"	CFM	235	315	390	470	550	630	705	785
14"	CFM	320	425	535	640	750	855	930	1070
15"	CFM	369	492	615	738	861	984	1107	1203
16"	CFM	413	555	690	826	968	1103	1380	1658

Performance Notes

1. All units have been tested in accordance with ANSI/ASHRAE 70-2006. Data in table is derived from such testing.
2. Ps – Static pressure required to obtain listed cfm, units of inches water gauge (in. wg.).
3. NC – Calculated noise criteria using 10 dB per octave room attenuation (dimensional).
4. Throw – Non-isothermal horizontal throw, in feet, for a terminal velocity of 50 fpm.
5. Ak – Area Factors.
6. Inlet Velocity = fpm (Feet Per Minute).

PSPRF, PSPFGFBR Return Air Grilles for T-Bar, Perforated

Neck Size	Inlet Velocity	200	300	400	500	600	700	800
		Negative Ps	-.01	-.03	-.05	-.08	-.11	-.15
12 x 12	CFM	170	250	335	420	505	590	670
	NC	<	<	<	20	25	30	35
24 x 12	CFM	350	525	700	875	1050	1225	1400
	NC	<	<	20	25	30	35	40
24 x 24	CFM	735	1100	1470	1835	2200	2570	2935
	NC	<	<	20	28	33	38	42
48 x 12	CFM	735	1100	1470	1835	2200	2570	2935
	NC	<	<	20	28	33	38	42
48 x 24	CFM	1500	2250	3000	3750	4500	5250	6000
	NC	<	20	28	33	38	42	35

PSSQCD Aluminum Louver Face Ceiling Diffusers

CFM	Size	6 x 6	8 x 8	10 x 10	12 x 12	14 x 14	16 x 16	18 x 18	20 x 20	22 x 22	24 x 24
100	Neck Velocity	400	225	114	100						
	PS	.004	.001	.001	.001						
	Throw	20 17 14 12	17 14 12 10	14 12 10 9	12 10 8 7						
200	Neck Velocity	800	450	288	200	147					
	PS	.014	.004	.002	.001	.001					
	Throw	33 27 23 20	27 22 19 16	23 19 16 14	21 17 14 12	18 15 13 11					
300	Neck Velocity		675	432	300	220					
	PS		.008	.004	.002	.001					
	Throw		35 30 25 22	35 30 25 22	27 22 19 15	24 20 17 15					
400	Neck Velocity		900	576	400	294					
	PS		.019	.008	.004	.002					
	Throw		47 39 32 29	40 34 28 24	35 30 25 22	32 27 22 19					
600	Neck Velocity			864	600	441	216				
	PS			.017	.008	.003	.001				
	Throw			52 43 36 32	43 36 30 26	41 34 28 25	30 25 21 19				
800	Neck Velocity				800	588	450	356	288	238	200
	PS				.018	.008	.005	.003	.002	.001	.001
	Throw				57 48 40 35	51 43 36 31	47 39 32 29	43 37 30 27	40 34 28 24	35 29 24 21	33 27 23 20
1000	Neck Velocity					735	563	444	360	298	250
	PS					.014	.009	.006	.003	.002	.001
	Throw					63 52 43 38	57 48 40 35	53 45 37 33	49 41 34 30	40 34 28 25	38 32 26 23

Performance Notes:

1. All data are tested in accordance with ANSI/ASHRAE 70-2006.
2. PS – Static Pressure.
3. Throw – Throws indicated are based on total number of feet of projected air when a terminal velocity of 50 fpm is reached. Numbers reported in chart are, from left to right, for 1, 2, 3 and 4-way throw patterns.
4. Inlet Velocity = fpm (Feet Per Minute).

PSPSI Ceiling Diffusers for T-Bar

Neck Size	Inlet Velocity	300	400	500	600	700	800	1000		
6"	CFM	60	80	100	115	135	155	195		
		Ps	.006	.012	.018	.022	.031	.043	.069	
		NC	<	<	>	<	20	24	31	
	Throw	4-W	3	4	4	5	6	7	8	
		3-W	3	4	5	6	6	8	8	
		2-W	4	5	5	6	7	9	9	
		1-W	5	5	6	7	8	9	10	
	8"	CFM	105	140	175	210	246	28	350	
			Ps	.011	.021	.032	.047	.064	.084	.133
			NC	<	<	<	21	26	30	36
Throw		4-W	3	5	5	6	8	10	11	
		3-W	3	5	5	6	8	11	12	
		2-W	4	6	6	7	9	12	13	
		1-W	5	6	7	8	10	13	14	
10"		CFM	165	220	270	325	380	435	545	
			Ps	.014	.025	.037	.054	.075	.098	.156
			NC	<	<	22	28	33	37	43
	Throw	4-W	4	5	6	7	8	10	12	
		3-W	4	6	7	8	9	12	13	
		2-W	5	6	8	8	10	14	15	
		1-W	6	7	9	10	11	14	16	
	12"	CFM	235	315	390	470	550	630	785	
			Ps	.026	.049	.074	.108	.149	.196	.305
			NC	<	<	25	29	35	40	46
Throw		4-W	4	8	8	10	11	12	14	
		3-W	5	8	9	11	13	14	15	
		2-W	6	9	11	12	13	15	16	
		1-W	8	9	12	13	14	16	18	
14"		CFM	320	425	535	640	750	855	1070	
			Ps	.033	.058	.092	.133	.182	.237	.373
			NC	<	23	29	34	39	44	50
	Throw	4-W	6	8	11	13	14	15	17	
		3-W	7	9	12	14	16	17	18	
		2-W	8	10	13	15	17	18	19	
		1-W	9	11	14	16	18	19	20	

Performance Notes

- All Units have been tested in accordance with ANSI/ASHRAE 70-2006. Data in table is derived from such testing.
- Ps – Static pressure required to obtain listed cfm, units of inches water gauge (in. wg.).
- NC- Calculated noise criteria using 10 dB per octave room attenuation (dimensionless).
- Throw – Non-isothermal throw, in feet, for a terminal velocity of 50 fpm.
- Inlet Velocity = fpm (Feet Per Minute).

PSPCBSST/PSPSBRST Perforated Supply

Neck Size	Inlet Velocity	300	400	500	600	700	800	1000	1200		
6"	CFM	60	80	100	120	135	155	195	235		
		Ps	.009	.016	.025	.038	.044	.059	.095	0.139	
		NC	<	<	<15	19	23	26	30	35	
	Throw	4-W	5	6	6	7	7	8	9	10	
		3-W	5	6	7	7	8	9	10	10	
		2-W	5	7	8	8	9	10	11	12	
		1-W	9	11	12	13	14	15	17	18	
	8"	CFM	105	140	175	210	245	280	350	420	
			Ps	.010	.018	.028	.041	.055	.072	.113	.162
			NC	<	<	<15	19	24	27	31	37
Throw		4-W	6	7	8	9	10	10	12	13	
		3-W	7	8	9	10	11	11	13	14	
		2-W	7	9	10	11	12	13	14	16	
		1-W	12	14	16	17	19	20	22	24	
10"		CFM	165	220	275	325	380	435	545	655	
			Ps	.011	.020	.031	.044	.059	.078	.124	.178
			NC	<	<	<15	20	25	29	34	39
	Throw	4-W	8	9	10	11	12	13	15	16	
		3-W	8	10	11	12	13	14	16	18	
		2-W	9	11	13	14	15	16	18	20	
		1-W	15	18	20	21	23	25	28	30	
	12"	CFM	235	315	395	470	550	630	785	940	
			Ps	.012	.023	.036	.052	.070	.093	.144	.205
			NC	<	<15	15	22	27	31	36	42
Throw		4-W	9	11	12	13	15	16	17	19	
		3-W	10	12	14	15	16	17	19	21	
		2-W	11	14	15	17	18	19	21	23	
		1-W	18	21	24	26	28	30	33	36	
14"		CFM	320	430	535	640	750	855	1070	1285	
			Ps	.011	.021	.032	.046	.063	.082	.129	.186
			NC	<	<15	16	24	29	33	38	44
	Throw	4-W	12	15	16	18	19	21	23	25	
		3-W	13	16	18	20	21	23	26	28	
		2-W	14	18	20	22	24	26	29	31	
		1-W	24	28	31	34	37	40	44	49	
	16"	CFM	413	555	690	826	968	1103	1380	1658	
			Ps	.012	.022	.037	.048	.065	.085	.132	.195
			NC	<15	15	17	25	30	34	39	45
Throw		4-W	15	18	19	21	23	25	27	29	
		3-W	16	19	22	23	25	27	30	32	
		2-W	17	20	23	25	27	29	33	35	
		1-W	30	34	37	41	45	49	54	57	

PSLFSI Ceiling Diffusers for T-Bar

Module Size	Neck Size	Neck Velocity Ps	200	300	400	500	600	700	800	900
			.032	.060	.094	.133	.176	.224	.275	.330
24 x 24	6"	CFM	40	60	80	100	120	135	155	175
		Throw	5	7	8	8	9	10	11	11
		NC	<15	<15	<15	18	23	26	32	34
24 x 24	8"	CFM	70	105	140	175	210	245	280	315
		Throw	7	9	10	11	12	13	14	15
		NC	<15	<15	<15	21	26	30	34	37
24 x 24	10"	CFM	110	165	220	275	325	380	435	490
		Throw	9	11	13	15	16	17	18	20
		NC	<15	<15	17	23	28	32	35	38
24 x 24	12"	CFM	155	235	315	395	470	550	630	705
		Throw	11	14	16	18	19	21	22	23
		NC	<15	<15	18	23	26	31	36	39
24 x 24	14"	CFM	215	320	430	535	640	750	855	960
		Throw	13	16	18	21	23	24	26	28
		NC	<15	16	23	26	31	37	39	43
24 x 24	15"	CFM	245	370	490	615	735	860	980	1105
		Throw	13	17	20	22	24	26	28	30
		NC	<15	17	23	29	34	38	40	43

PSAMODOB, PSAMCTB, PSAMCTBSB Aluminum Square Ceiling Diffusers for T-Bar

Size Area Ak	Inlet Velocity Ps	200	300	400	500	600	700
6 x 6	CFM	50	75	100	125	150	175
	Throw	6-4-4-3	8-6-6-4	10-7-7-5	12-8-8-6	14-10-10-7	16-11-11-8
	NC	<20	<20	<20	20	26	31
8 x 8	CFM	90	130	175	220	265	310
	Throw	8-6-6-4	10-7-7-5	14-10-10-7	16-11-11-8	18-13-13-9	20-14-14-10
	NC	<20	<20	<20	23	28	33
10 x 10	CFM	140	205	275	345	415	485
	Throw	10-7-7-5	14-10-10-7	18-13-13-9	20-14-14-10	24-17-17-12	26-18-18-13
	NC	<20	<20	<20	23	26	31
12 x 12	CFM	200	300	400	500	600	700
	Throw	12-8-8-6	16-11-11-8	20-14-14-10	24-17-17-12	28-20-20-14	30-21-21-15
	NC	<20	<20	<20	25	31	36
14 x 14	CFM	270	405	545	680	815	950
	Throw	14-10-10-7	20-14-14-10	24-17-17-12	28-20-20-14	34-24-24-17	36-25-25-18
	NC	<20	<20	21	27	33	38
16 x 16	CFM	355	530	710	885	1070	1245
	Throw	16-11-11-8	22-16-16-11	28-20-20-14	32-22-22-16	38-27-27-19	40-28-28-20
	NC	<20	<20	21	28	33	38
18 x 18	CFM	450	670	900	1120	1345	1570
	Throw	18-13-13-9	24-17-17-12	30-21-21-15	36-25-25-18	42-30-30-21	46-32-32-23
	NC	<20	<20	22	29	34	39
20 x 20	CFM	555	830	1110	1390	1670	1945
	Throw	20-14-14-10	26-18-18-13	32-22-22-16	40-28-28-20	46-32-32-23	48-34-34-24
	NC	<20	<20	23	30	35	40
22 x 22	CFM	670	1010	1345	1680	2015	2350
	Throw	22-16-16-11	30-21-21-15	36-25-25-18	44-31-31-22	50-35-35-25	54-38-38-27
	NC	<20	<20	23	31	36	41
24 x 24	CFM	800	1200	1600	2000	2400	2800
	Throw	24-17-17-12	32-22-22-16	40-28-25-20	48-34-34-24	56-39-39-28	60-42-42-30
	NC	<20	<20	26	32	38	42

Performance Notes

1. All units have been tested in accordance with ANSI/ASHRAE 70-2006. Data in table is derived from such testing.
2. Ps – Static pressure required to obtain listed cfm, units of inches water gauge (in. wg.).
3. NC- Calculated noise criteria using 10 dB per octave room attenuation (dimensionless).
4. Throw – Non-isothermal throw, in feet, for a terminal velocity of 50 fpm.
5. Inlet Velocity = fpm (Feet Per Minute).

PSRADW Steel Round Fixed Ceiling Diffusers

Neck Size	Neck Area Sq Ft	Inlet Velocity	PS									
			200	300	400	500	600	700	800	900	1000	1100
6"	.165	CFM	39	59	79	98	118	137	157	177	196	216
		NC	<15	<15	16	18	21	23	26	28	31	33
8"	.307	CFM	70	105	140	175	209	244	279	314	349	384
		NC	<15	16	18	21	23	26	28	31	33	36
10"	.493	CFM	109	164	218	273	327	382	436	491	545	600
		NC	16	18	20	23	25	28	30	33	35	38
12"	.722	CFM	157	236	314	393	471	550	628	707	785	864
		NC	17	20	22	24	27	29	32	34	37	39
14"	.995	CFM	214	321	428	535	641	748	855	962	1069	1176
		NC	18	21	23	26	28	31	33	36	38	40
16"	1.312	CFM	279	419	559	698	838	977	1117	1257	1396	1536
		NC	20	22	25	27	29	32	34	37	39	42
18"	1.673	CFM	353	530	707	884	1060	1237	1414	1590	1767	1944
		NC	21	23	26	28	30	33	35	38	40	43
20"	1.673	CFM	436	654	873	1091	1309	1527	1745	1963	2182	2400
		NC	22	24	26	29	31	34	36	39	41	44
22"	1.673	CFM	528	792	1056	1320	1584	1848	2112	2376	2640	2904
		NC	22	25	27	30	32	35	37	39	42	44
24"	3.016	CFM	628	942	1257	1571	1885	2199	2513	2827	3142	3456
		NC	23	26	28	30	33	35	38	40	43	45
Throw			5	8	10	13	15	18	20	23	25	28

Damper Table	
% Damper Open	Add to Listed NC
100%	0
82%	4
70%	8
50%	16

Performance Notes

1. Tabulated radial throw in feet is based on a 9' ceiling height, with supply air 20°F cooler than room temperature, MAX Horizontal Throw @ Vt = 50 fpm.
2. Vertical down projection air pattern with cooling supply air temperature 20°F below room temperature, and diffuser inner cones in up position: multiply the tabulated radial throw values by a factor of 0.80 to obtain vertical down projection distance at MIN and MAX (Vt) terminal velocities.
3. Vertical down projection air pattern with heating supply air temperature 20°F above room temperature, and diffuser inner cones in up position: multiply the tabulated radial throw values by a factor of 0.60 to obtain vertical down projection distance at MIN and MAX (Vt) terminal velocities.
4. PS – are in inches of water.
5. PSRADW Round Diffusers are tested in accordance with ASHRAE 70-2006. Sound data are calculated in accordance with International Standard ISO 3741 comparison method. The NC values are based on a room absorption of 10 dB for sound power level (Lw) RE: 10E-12 watts. (<) symbol indicates NC less than number given. The NC data are for single diffusers. For results of throttling a volume damper, see Damper Table.
6. All data are applicable for exposed duct mounting or ceiling installation.
7. Inlet Velocity = fpm (Feet Per Minute).

PSCDBX Ceiling Diffuser Boxes 4-Way

Size	Area Ak	Inlet Velocity	450	550	650	750	850	950	1100	1300	1500	1700	1900
14 x 14	0.96	CFM	431	527	622	718	814	909	1053	1244	1436	1627	1819
		Pt	0.05	0.08	0.10	0.14	0.02	0.21	0.27	0.37	0.48	0.60	0.74
18 x 18	1.16	CFM	522	638	754	870	986	1102	1276	1508	1740	1972	2204
		Pt	0.04	0.05	0.07	0.08	0.10	0.13	0.16	0.22	0.28	0.35	0.42
20 x 20	1.34	CFM	604	737	871	1105	1139	1273	1474	1742	2010	2278	2546
		Pt	0.04	0.05	0.07	0.09	0.11	0.13	0.17	0.24	0.30	0.38	0.46
22 x 22	1.67	CFM	752	920	1087	1254	1421	1588	1838	2172	2507	2841	3175
		Pt	0.02	0.03	0.05	0.07	0.09	0.11	0.15	0.21	0.29	0.38	0.48
24 x 24	1.82	CFM	821	1003	1186	1368	1551	1733	2007	2372	2736	3101	3466
		Pt	0.04	0.06	0.08	0.10	0.12	0.15	0.19	0.26	0.33	0.41	0.50
30 x 30	2.79	CFM	1258	1538	1818	2097	2377	2656	3076	3635	4194	4754	5313
		Pt	0.03	0.05	0.07	0.09	0.11	0.14	0.18	0.25	0.32	0.41	0.51
36 x 36	3.51	CFM	1580	1932	2283	2634	2985	3336	3862	4564	5267	5969	6671
		Pt	0.04	0.05	0.07	0.09	0.11	0.13	0.17	0.23	0.29	0.36	0.44

Pt – Total pressure in inches of water (in. wg.).

Cross Reference

RESIDENTIAL CROSS REFERENCE

PROSELECT	Hart & Cooley	Airmate Selkirk	Continental	Lima	Metal Fab	Shoemaker	Tru-Aire	US Aire	AirFlow	J&J
PS1WW	681	180	21	601	N/A	N/A	101M	1101M	N/A	601
PS2WW	682	160	22	602	N/A	850	102M	1102M	A52	602
PS3WW	683	140	23	603	MFSCR	845	103M	1103M	A53	603
PS4WW	684	190	24	604	MFSCR	150	104M	1104M	A84	604
PS2W3W	661	163	32	632	MF3SCR	833	132M	1132M	N/A	632
PS3W3W	631	143	33	633	N/A	N/A	N/A	1133M	N/A	633
PS1CW	301	601-HM	C1H	501	MFCSR	201H	401M	1201M	A21	CB1
PS2CW	302	602-HM	C2H	502	MFCSR	202H	402HM	1202M	N/A	CB2
PS3CW	303	603-M	C3	503	MFCSR	203	403M	1203M	A23	CB3
PS4CW	304	604-M	C4	504	MFCSR	204	404M	1204M	A24	CB4
PSVAFW	821	220-V	RVML	900V	N/A	951	210VM	100SVM	A64	900V
PSHFSW	94A	280	FBG/RGH-40	S90H	N/A	935	270	SRH	N/A	S90H
PSRGW	672	170	G25	60GH	MFRG	1050	170	1400	A87	60GH
PSRG3W	650	173	G35	63GH	MF3RG	1033	173	N/A	N/A	63GH
PSFGW	673	170FF	FG2	60GHFF	MFRFG	FG	190/190RF	1410F	A89	60GHFF
PSFG3W	659	173FF	FG3	N/A	MF3RFG	N/A	N/A	N/A	N/A	N/A
PSFBFGW	96AFB	280FF	FBFG	N/A	N/A	920FG	290	SRHF	A69	S90HFF
PSFD	421	300-OS	28	800	MFFR	350	150M	1510D	A51	800
PSDFD	411	302	N/A	850	N/A	375	N/A	N/A	N/A	850
PSFRD	210	325-M	F20	830	N/A	1550	N/A	1530M	N/A	830
PSFRGB	265	325	F25	825	MFFG	1600	154R	1530	N/A	825
PSTS	420	301	TG32	875	MFTSG	TS	150T	1320	N/A	875
PSBBR783W	664	164	B32	667	N/A	855	124M	N/A	N/A	N/A
PSRG78W	674	171	BG21	60GH7	MFBG	1150	122R	1300	N/A	60GH7
PSRG783W	657	174	BG31	671	MF3BG	1133	123R	N/A	N/A	671
PSBBD	406	350	150/180	470	MFB	875	1155/1185	1330/1340	N/A	470
PSBBR	407	351	1505/1805	471	N/A	N/A	118R	1341	N/A	471
PSBBRD	655	N/A	55	649	N/A	N/A	N/A	N/A	N/A	649
PSBRG3W	658	N/A	BEG31	652	N/A	N/A	N/A	N/A	N/A	652
PSRCD	16	800	16	150	MFCV	90	800	900	N/A	150
PSRDR	12	800-D	12B	155	MFCDD	91	801	900-D	N/A	155
PSDR	11	800R	11	156	N/A	92	803	N/A	N/A	156
PSAASW	A618MS	A 420-VM	AVM	AL278ML	N/A	950	A210V	VM	N/A	AL278ML
PSA1CW	A611MS	A 451-HM	N/A	AL271ML	N/A	CB10C	A301M	LM	N/A	AL271ML
PSA2CW	A612MS	A 452-HM	N/A	AL272ML	N/A	CB20C	A302HM	LTM	N/A	AL272ML
PSA3CW	A613MS	A 453-M	N/A	AL273ML	N/A	CB30A	A303M	LT3M	N/A	AL273ML
PSA4CW	A614MS	A 454-M	N/A	AL274ML	N/A	CB40	A304M	LT4M	N/A	AL274ML
PSA3W	A503MS	E 1053-M	AE3	AL163ML	MFEASC	N/A	A503M	5200D S3	N/A	AL163ML
PSA4W	A504MS	E 1054-M	AE4	AL164ML	MFEASC	N/A	A504M	5200D S4	N/A	AL164ML
PSP2WW	RZ682	N/A	N/A	RZ602	N/A	N/A	N/A	N/A	N/A	RZ602
PSP3WW	RZ683	N/A	N/A	RZ603	N/A	N/A	N/A	N/A	N/A	RZ603
PSP4WW	RZ684	N/A	N/A	RZ604	N/A	N/A	N/A	N/A	N/A	RZ604

COMMERCIAL CROSS REFERENCE

PROSELECT	Hart & Cooley	Airmate / Selkirk	Continental	Metal Fab	Shoemaker	Tru-Aire	US Aire	J&J	Carnes	Titus	Krueger
PSHVD	FPD	1302-2	FPD	MFLC2C	HVL	2003CD	4700-6	1520	SFTB	TMS	1450
PSHVD3	FPD3	1300-2	BHV	MFLC3C	HVD/FTD	2004CD	4800-6	1500	SFTA/SJTB	TMS-A-3	1400
PSHVD3I	FPD3R6	1300-2 INS R6	BHVNI	MFLCI3C	HVD-TV B	2004CD-IN	4806-6	1540	SFTB	N/A	1400 IB
PSHVD32424	HVS	1300-INS	HVS	N/A	HVD-TV B / FTD-TV B	N/A	5901-6	1560	SJTB	TMS-A-3	1400
PSSPD	DPD	1300FP-2	OPD	N/A	HL	N/A	4750-6	1580	SFPA	OMNI	PLQ
PSPRDI2424	RENP	782-RA	RFFA	MFLCIRGP	111	1010MAR	7300R-6	4230	N/A	N/A	6390VEQ
PSPSDI2424	RENPS	782-SA	RFF4A	MFLCISDP	110	1010MAS	7300-6	4235	N/A	N/A	6304VEQ
PSPFBR	FBR	N/A	CS-DBP	N/A	N/A	1120R	7350R	1276	N/A	PAR-1B	6290
PSPFBS	FBCS	N/A	CS4-DBP	N/A	N/A	1120S	7350	N/A	N/A	PAS-1B	N/A
PSPSBSST	SBP	2100	N/A	N/A	780	1020MAS	7500-6	1235	SPAB	PAS	6404
PSPSI	PDS	2100 INS	PDS	N/A	781	N/A	7500	N/A	SPAB	N/A	6404
PSPCBSST	CBPS / CBPSEQ	704	6800	N/A	825	1400CB	7600-6	1234	SPFC	PCS	6500
PSPCBRST	CBPR / CBPREQ	2100RA	6500	N/A	830	1444RG	7600R-6	N/A	SPRB	PAR	6590
PSPRF	PD	700-P	CSFOP	N/A	PT	1920RG	SPRTB	1274	SPHB	N/A	6790
PSSQCD	N/A	1030 C/B	N/A	N/A	100D	560M	5200-2D	1104	N/A	TDC-AA	SH
PSSQCILD	24	N/A	N/A	N/A	100	N/A	5200	1100	N/A	N/A	N/A
PSLFSI	SRET R6	N/A	N/A	N/A	DVD T	N/A	5500 SI-6	4214	SKTA	TDC-AA	5SH
PSAMODOB	MCDS	N/A	N/A	N/A	MAO	N/A	9000-1 OBD	1444 OBD	SMAB	MCD	51240
PSAMODOBT	MCDST	N/A	N/A	N/A	725MA O	N/A	9000-6 OBD	AL1444-33 OBD	SMDB	N/A	N/A
PSAMCTB	MCDS TSR	N/A	N/A	N/A	700MA	N/A	9000-6 TR	AL1444-33 RND BACK	SMAB	MCD-3	51240
PSA1COBE	CHD1	E 401-HO	N/A	N/A	CB10-C-O	A3010	LD	ALC10BD	RNCMH	250-AAL1 W/AG-15	5181LOBD
PSA2COBE	CHD2	E 402-HO	N/A	N/A	CB20-C-O	A302HO	LTD	ALC20BD	RNCMN	250-AAL2 W/AG-15	5182LOBD
PSA3CMSE	CM3	E 403-M	N/A	N/A	CB30-A	A3030	LS3M	ALC3ML	N/A	250-AAL3 W/AG-20	2183LM
PSA4COB	CD4	E 404-O	N/A	N/A	CB40-O	A3040	LS4D	ALC40BD	RNCMF	250-AAS4 W/AG-15	51840BD
PSA4CMSE	CM4	E 404-M	N/A	N/A	CB40	A304M	LS4M	ALC4ML	N/A	N/A	N/A
PSRADW	RD	N/A	3900	N/A	BD	N/A	RSD	R42	SSEA	TMR	RM1
PSCDBX	ECBX	1100	N/A	N/A	400	600	N/A	1150	N/A	N/A	N/A
PSAHOBE	ECFM	N/A	N/A	N/A	901-O	A210HO	H4002D	AL90H0BD	N/A	N/A	N/A

COMMERCIAL CROSS REFERENCE

PROSELECT	Hart & Cooley	Airmate / Selkirk	Continental	Metal Fab	Shoemaker	Tru-Aire	US Aire	J&J	Carnes	Titus	Krueger
PSAVH	VH	E 240-V	N/A	N/A	904	A210V	V4004	ALVH	RADMV	272FL W/ AG-35-AA	5880V
PSAVHOB	VHD	E 240-VO	N/A	N/A	904-O	A220VO	V4004D	ALVHOB	RNGMV	272FS W/ AG-35-AA	5880VOBD
PSAHVOB	HVD	E 240-HO	N/A	N/A	903-O	A220HO	H4004D	ALHVOBD	RNDMH	272FL W/ AG-35-AA	5880HOB
PSVOB	VD	E 200-VO	N/A	N/A	902-O	A210VO	V4002D	ALVOBD	RNSMV	271FS W/ AG-35-AA	580VOBD
PSGDDSD	USVH	N/A	N/A	N/A	SD34	N/A	4004SP-1	USDVH	RDDM	US300FL	DMGDRH
PSAH45	RH45	E 280	AFBG40	N/A	905	A270	RHE-1	ALHR45	RAAMH	3FL	S580H
PSAH45TB	RH45T	NA	N/A	N/A	900T	N/A	RHE-6	ALHR45T	RAAMH-E	3FL-3	S585HZ
PSAH45FG	RHF45	E280FF	N/A	N/A	900 FG	A290	RHEF-1	ALH45FF / ALS90HFF	RAAM	3FFL	S580H-5FF
PSAH45FTB	RHF45T	ETB 280FF	N/A	N/A	900 TFG	N/A	SRHF TB	ALH45TFF	RAAMH-T	3FFL-3	S80HFF
PSFGFHB	96AFBT	TB-280FF	FBFGTB	N/A	N/A	1210RG	SRHF-6	S90HFF	RSAB	350RL1	N/A
PSFGFHB	96AFBT	N/A	N/A	N/A	N/A	N/A	SRHF-6 FGBP	S90HFFI	N/A	N/A	N/A
PSFGFBR	PFTI	N/A	CS106P	N/A	106 PFG	1120DBR	SRP20F	12PFFI	N/A	N/A	6290F
PSAEC5	RE5	E 900	N/A	N/A	600	N/A	CC5	ALEC5	RAPAF	50F	EGC5
PSAEC5TB	RE5T	N/A	N/A	N/A	600 T	1140R	CC5-6	ALEC5 W/ TB PNL	RAPAH	50F-3	EGC-5-TB
PSAEC5ITB	RE5TI	ETB 900 INS	N/A	N/A	601 T	1140DBR	CC5-6 W/ FGBP	N/A	RAPAH	N/A	EG5FTB
PSAEC5FG	REF5	E 900FF	N/A	N/A	600FG	N/A	CC5F	ALEC5FF	RAPMF	50FF	EGC5-5FF
PSFGTB	659T	TB 173FF	TL3	N/A	105FG	4010	1410F	N/A	RSAB	355RLF1	S85HZFF
PSFGTBI	659TI	N/A	TL3106	N/A	106FG	N/A	1420F	N/A	RSAB	N/A	N/A
PSFGBP	N/A	3750753	P106	N/A	TVB	N/A	FGBP	N/A	N/A	N/A	N/A
PSSMF	SMF	07392424CW	ASMF	N/A	SMTB	N/A	TBPF	AL10PF	KXFAA	TRM	5HCF23
PSRAD	20	N/A	N/A	N/A	RD	N/A	3100S-1	1600	SSMA	TMR	RA-2
PSSICR	H540010	N/A	5400	MFLCCR	N/A	N/A	N/A	1565	N/A	N/A	N/A
PSDB	3800	800-DO	3800	MFLCVD	N/A	802	BDS	R22	N/A	N/A	N/A
PSSIIP	5400PP	N/A	PF175	N/A	N/A	N/A	PUSH PIN	N/A	N/A	N/A	N/A
PSID	66	N/A	N/A	N/A	N/A	N/A	INLET DAMPER	N/A	N/A	N/A	N/A
PSLSRS1B	69	N/A	N/A	N/A	N/A	N/A	N/A	N/A	N/A	N/A	N/A
PSLSRS2B	70	N/A	N/A	N/A	N/A	N/A	N/A	N/A	N/A	N/A	N/A
PSLSWSHR	704	N/A	N/A	N/A	N/A	N/A	N/A	N/A	N/A	N/A	N/A



FNW410A	63	PFBG300N	71
FNW411A	63	PFBG30K	71
FNW470	64	PFBG30L	71
FNW475	64	PFBG5L	71
FNW490	64	PFBG60K	71
FNW495	64	PFBG60L	71
FNW9S0120AT	72	PFPT22010	65
FNW9S0160AT	72	PFPT26010	65
FNW9S30240AT	72	PFSSHC62602	66
FNWG0100R	71	PFSSHC62606	66
FNWG0160R	71	PFSSHC63152	66
FNWG0200R	71	PFSSHC63248	66
FNWG0300R	71	PFSSHC6706	66
FNWG030R	71	PFSSHC6708	66
FNWG060R	71	PFSSHC6710	66
FNWLF0100L	71	PFSSHC6712	66
FNWLF0160L	71	PFSSHC6716	66
FNWLF0200L	71	PFSSHC6720	66
FNWLF0300L	71	PFSSHC6724	66
FNWLF030L	71	PFSSHC6728	66
FNWLF060L	71	PFSSHC6732	66
FNWSDTHN	72	PFSSHC6736	66
FNWX415	63	PFSSHC6740	66
FNWX416	63	PFSSHC6744	66
FNWX480A	63	PFSSHC6748	66
FNWX485A	64	PFSSHC6752	66
PF100C22F50	65	PFSSHC6756	66
PF100G20F10	65	PFSSHC6764	66
PF100G24F10	65	PFSSHC6772	66
PF100G24F100	65	PFSSHC6780	66
PF100G24F50	65	PFSSHC6788	66
PF100S24F10	66	PFSSHC6796	66
PF100S24F100	66	PFSSHC6799	66
PF100S24F50	66	PFSSHC6806	66
PF101G28F10	65	PFSSHC6808	66
PF101G28F100	65	PFSSHC6810	66
PF101G28F50	65	PFSSHC6810A	66
PF42860	63	PFSSHC6812	66
PF42861	63	PFSSHC6816	66
PFC100WHT	70	PFSSHC6820	66
PFC200WHT	70	PFSSHC6824	66
PFC300WHT	70	PFSSHC6828	66
PFC301WHT	70	PFSSHC6832	66
PFC401WHT	70	PFSSHC6836	66
PFC500ALU	70	PFSSHC6840	66
PFC500CLR	70	PFSSHC6844	66
PFC500WHT	70	PFSSHC6848	66
PFC600CLR	70	PFSSHC6852	66
PFC700RED	70	PFSSHC6856	66
PFCG	70	PFSSHC6864	66
PFBG100K	71	PFSSHC6872	66
PFBG15K1	71	PFSSHC6880	66
PFBG30K	71	PFSSHC6888	66
PFBG60K	71	PFSSHC6896	66
PFM90037	70	PFWG300L	71
PFBG100K	71	PFWGI300L	71
PFBG100L	71	PFXPG100K	71
PFBG100N	71	PFXPGLF100K	71
PFBG15K1	71	PFXT12	78
PFBG160K	71	PFXT12I	78
PFBG160L	71	PFXT5	78
PFBG200K	71	PFXT5I	78
PFBG200L	71	PS0402	69
PFBG200N	71	PS0403	69
PFBG300K	71	PS0404	69
PFBG300L	71	PS0503	69

PS0504	69	PSAH45FGW	52
PS0602	68	PSAH45FTB	53
PS0603	68	PSAH45TB	52
PS0604	68	PSAH45W	51
PS0605	69	PSAHOBEW	49
PS0606	69	PSAHVOBW	50
PS0644	61	PSAMCTB	45
PS0645	61	PSAMCTBSB	45
PS0646	61	PSAMODOB	44
PS0648	61	PSAPC	59
PS0649	61	PSARGW	24
PS0650	61	PSAVH	49
PS0651	61	PSAVHOBW	49
PS0652	61	PSBBD	35
PS0653	61	PSBBR783W	33
PS10001	61	PSBBRD	35
PS10007	62	PSBBRW18	35
PS1CW	13	PSBIT10D100	65
PS1CWML	14	PSBIT10D500	65
PS1WW	7	PSBIT10F100	65
PS2CW	14	PSBIT10F1000	65
PS2W3W	10	PSBIT10F500	65
PS2WW	8	PSBIT10F5000	65
PS2WWML	9	PSBIT10G100	65
PS3CW	15	PSBIT10G500	65
PS3CWML	15	PSBIT8D100	65
PS3W3W	12	PSBIT8D1000	65
PS3WW	11	PSBIT8D500	65
PS3WWML	11	PSBIT8F100	65
PS4CW	16	PSBIT8F1000	65
PS4CWML	16	PSBIT8F500	65
PS4WW	12	PSBP	59
PS4WWML	13	PSBRG3W	36
PS546	61	PSCDBXW	48
PS546BP	61	PSCP15	62
PS548	61	PSCP15WS	62
PS548BP	61	PSCP15WS20T	62
PS549	61	PSCP20LPWS	62
PS550	61	PSCP20WS	62
PS551	61	PSCP20WS20T	62
PS552	61	PSCP24WS	62
PS67191	61	PSCP45WS	63
PS67192	61	PSCP720FSS	63
PS67193	61	PSCPE18383	64
PS67194	61	PSCPE24243	64
PS67195	61	PSCPE24302	64
PS67196	61	PSCPE24362	64
PS67198	61	PSCPE24363	64
PS9546	62	PSCPE24362	64
PS9548	62	PSCPE24363	64
PSA1COBEW	46	PSCPE26262	64
PSA1CW	18	PSCPE30302	64
PSA2COBEW	46	PSCPE30303	64
PSA2CW	18	PSCPE30362	64
PSA3CMSEW	47	PSCPE30402	64
PSA3CW	19	PSCPE30403	64
PSA3W	37	PSCPE32322	64
PSA4CMSEW	47	PSCPE32323	64
PSA4COB	47	PSCPE32382	64
PSA4CW	19	PSCPE32442	64
PSA4W	38	PSCPE32443	64
PSAASW	17	PSCPE34342	64
PSAEC5	54	PSCPE36362	64
PSAEC5FG	55	PSCPE36363	64
PSAEC5ITB2222	55	PSCPE36402	64
PSAEC5TB	55	PSCPE36403	64





PSCPE36482	64	PSGTTD520	68
PSCPE36483	64	PSHDFBD	62
PSCPE38422	64	PSHDFBF	62
PSCPE38423	64	PSHDFBG	62
PSCPE38703	64	PSHDFBH	62
PSCPE40403	64	PSHDFBJ	62
PSCPE45583	64	PSHDFBK	62
PSCPE48483	64	PSHFSW	23
PSCPE48723	64	PSHVD	40
PSCPE52523	64	PSHVD32424	40
PSCPE56583	64	PSHVD3I	40
PSCPMS115	63	PSHVD3IBD	40
PSCPMS230	63	PSIDU	58
PSCPMSOP230	63	PSLFSI2424	44
PSCTB11	64	PSLS	59
PSCTB14	64	PSLSD	60
PSCTB24	64	PSMTTD260	68
PSCTB36	64	PSMTTD520	68
PSCTB48	64	PSMTTF520	68
PSCTBV	64	PSP2WWW	21
PSCTBV1000	64	PSP3WWW	21
PSCTN36	64	PSP4WWW	22
PSCTN48	64	PSPCBRST	42
PSDB	58	PSPCBSST	42
PSDFD	31	PSPFB	41
PSDR	37	PSPFGFBR	54
PSDTC260B	68	PSPRDI2424	41
PSDTC260S	68	PSPRF	43
PSDTU260S	68	PSPSBSST	41
PSFBFG2W	29	PSPSDI2424	41
PSFD	30	PSPSI	42
PSFG3W	28	PSRAD	57
PSFGBP	57	PSRADW	46
PSFGFHB	53	PSRCDW	36
PSFGTBIW	56	PSRDR	36
PSFGTBW	56	PSRG3W	26
PSFGW	27	PSRG783W	34
PSFRD	31	PSRG78W	34
PSFRGB	32	PSRGW	25
PSG12152	66	PSSICR	57
PSG12153	66	PSSIIP	58
PSG12154	66	PSSMF2424	57
PSG12252	66	PSSPD	40
PSG12253	66	PSSPDI	40
PSG12254	66	PSSQCD	43
PSG14102PK	67	PSTC18	78
PSG14103PK	67	PSTC24	78
PSG14104PK	67	PSTC30	78
PSG14302PK	67	PSTC36	78
PSG14303PK	67	PSTS	33
PSG14304PK	67	PSTSL11NP	69
PSG16323	67	PSTSL11P52	69
PSG17552	67	PSTSL21P52	69
PSG17553	67	PSTSL21NP	69
PSG17554	67	PSTTD260	68
PSG18156	67	PSTTD520	68
PSG20152	67	PSTTF260	68
PSG20153	67	PSTTF520	68
PSG20154	67	PSTTG520	68
PSG20452	68	PSVAFW	20
PSG20453	68	PSVOBW	50
PSG20454	68	PSW12101	78
PSG20483PK	68	PSW12102	78
PSG20484PK	68	PSW12103	78
PSGDDSD	48	PSW12104	78
PSGTTD260	68	PSW12501	78

PSW12503	78	RAP16004	74
PSW12509	78	RAP16007	74
PSW12601	78	RAP16009	74
PSXET	68	RAP16012	74
PSZIP10D1000	65	RAP16013	74
PSZIP10F100	65	RAP16014	75
PSZIP10F1000	65	RAP16501	73
PSZIP10F5000	65	RAP16504	74
PSZIP7D100	65	RAP16505	74
PSZIP7D1000	65	RAP16506	74
PSZIP7D15000	65	RAP16507	74
PSZIP7D5000	65	RAP16508	74
PSZIP8D100	65	RAP16512	73
PSZIP8D1000	65	RAP17002	77
PSZIP8D12000	65	RAP17004	77
PSZIP8F100	65	RAP17006	77
PSZIP8F1000	65	RAP17007	77
PSZIP8F10000	65	RAP18001	76
PSZIP8F5000	65	RAP18002	76
PSZIP8G1000	65	RAP18003	76
PSZIP8G500	65	RAP18006	76
PSZIP8G5000	65	RAP18007	76
PSZIP8J1000	65	RAP18008	76
PSZIP8J250	65	RAP18009	76
PSZIP8J5000	65	RAP18010	76
PSZIP8JW250	65	RAP18011	76
PSZIP8K100	65	RAP18024	76
PSZIP8K1000	65	RAP18550	76
PSZIP8K250	65	RAP18551	76
PSZIP8KW250	65	RAP18552	76
PSZIP8KW50	65	RAP31201	72
PSZIP8KWFH250	65	RAP31202	72
RAP10501	74	RAP31203	72
RAP10502	74	RAP31204	73
RAP10520	74	RAP31206	72
RAP10543	74	RAP31207	72
RAP11002	70	RAP31401	72
RAP11003	71	RAP31402	72
RAP11502	76	RAP31601	72
RAP12501	76	RAP31602	72
RAP12504	76	RAP32001	73
RAP12507	76	RAP33003	73
RAP12509	77	RAP33004	73
RAP12518	77	RAP33005	73
RAP12525	77	RAP41201	73
RAP13002	75	RAP50145	76
RAP13003	75	RAP90101	67
RAP13004	75	RAP90102	67
RAP14500	77	RAP90103	67
RAP14503	75	RAP90201	67
RAP14504	75	RAP90202	67
RAP14506	75	RAP90203	67
RAP14507	75		
RAP14508	75		
RAP14509	75		
RAP14550	75		
RAP14551	75		
RAP14552	75		
RAP14553	75		
RAP14560PK	75		
RAP15502	73		
RAP15507	73		
RAP15508	73		
RAP16001	74		
RAP16002	74		
RAP16003	74		



Backpans, Fiberglass	56	Ceiling Diffuser Boxes 4-Way	48
Brushes,		Floor,	
Acid	61	Stamped Steel	30
Chip	61	Stamped Steel, Deluxe	31
Fitting	61-62	Galvanized Steel Double Deflection Spiral Duct	48
Pipe Dope	62	Linear Slot & Pattern,	
Cable Ties	64	Linear Slot Diffusers	59
Caulk,		Adjustable Pattern Controllers, Supplies for T-Bar, Non-Insulated/Insulated	59
100% Silicone	70	Round Ceiling	36
Acrylic Latex	70	T-Bar, Steel, High Velocity,	
Expanding Foam	70	2-Cone	39
Latex Tub & Tile	70	3-Cone	40
RTV High Temperature Silicone	70	3-Cone, Insulated, No Neck	40
Siliconized Acrylic	70	4-Way	16
Siliconized Acrylic Latex	70	4-Way, Metal Lever	16
Caulk Guns	70-71	T-Bar, Steel Square Plaque,	
Cloths,		For T-Bar Lay-in Ceiling Grids	40
Open Mesh Abrasive	68-69	For T-Bar Lay-in Ceiling Grids, Insulated	40
Sand	69	Duct Rings	37
Condensate Pumps	62-63	Filter Grilles,	
Condensate P-Traps	63	Fixed Bar	29
Condensate Running Traps	63	Stamped Steel Face,	
Condensate Safety Switches	63	For T-Bar	56
Condenser Pads	64	With Fiberglass Plenum, for T-Bar	56
Cords,		Steel Face,	
Extension	72-73	For T-Bar Ceilings	53
Ground Fault Current Interrupters	73	For T-Bar Ceilings, Insulated	53
Power Block Adapters	73	For T-Bar Ceilings, Perforated	54
Power Supply	73	Gauges,	
Curved Blades,		Gas Test	71
Extruded Aluminum,		Mechanical Pressure	71
Multi-Shutter Damper, 3-Way	47	Pressure	71
Multi-Shutter Damper, 4-Way	47	Water Test	71
Opposed Blade Damper, 1-Way	46	Gloves,	
Opposed Blade Damper, 2-Way	46	Cut Resistant	66
Opposed Blade Damper, 4-Way	47	Disposable	67
Dampers,		Driver	67
Butterfly	58	Jersey	67
Inlet	58	Knit	67
Radial Shutter	57	Mechanics	67
Round Ceiling	36	PVC	67
Diffusers,		Work	68
Aluminum Ceiling,		Grilles, Stamped Steel Toe Space	33
3-Way	37	Hammers	76-77
4-Way	38	Hanger Straps	65-66
Baseboard	35	Hardware	58
Ceiling, for T-Bar,		Hex Key Sets	75
Aluminum Louver Face	43	Horizontal Blades,	
Aluminum Modular Core with Square Back	45	Aluminum, Fixed,	
Aluminum Modular Core with Square to Round Back	45	Return Filter Grilles	52
Aluminum Square	44	Return T-Bar Filter Grilles	53
Expanded Metal Face	41	Returns	51
Perforated Returns	42	Returns for T-Bar	52
Perforated Shallow Back	41	Hose Clamps	66
Perforated Supply	42	Inlet Collars	57
Perforated Supply with Target Back	41	Levels, Torpedo	77
Perforated with Insulated Back	42	Nut Drivers	75
Return Air Grilles, Perforated	43	Plaster Frames, T-Bar	57
Steel Louver Face	44		
Steel Round Fixed	46		

Plenums, Steel Boot,	
Insulated/Non-Insulated	59
Pliers	76
Push Pins	58
Registers,	
Aluminum, Sidewall	17
Aluminum, Sidewall/Ceiling, Curved,	
1-Way	18
2-Way	18
3-Way	19
4-Way	19
Baseboard,	
1/3" Fin	33
With Damper	35
Floor	31
Plastic, Sidewall/Ceiling,	
2-Way	21
3-Way	21
4-Way	22
Stamped Steel, Curved Blade,	
1-Way	13
1-Way, Metal Lever	14
2-Way	14
3-Way	15
3-Way, Metal Lever	15
Stamped Steel, Sidewall/Ceiling,	
1-Way	7
2-Way	8
2-Way, Metal Lever	9
2-Way, 1/3" Fin	10
3-Way	11
3-Way, Metal Lever	11
3-Way, 1/3" Fin	12
4-Way	12
4-Way, Metal Lever	13
Supply,	
Vertical Blade	20
Vertical Blade with Opposed Blade Damper	50
Return Air Grilles,	
1/2" Fin, 7/8" Turnback	34
Floor	32
Stamped Aluminum	24
Stamped Steel	25
Stamped Steel Baseboard, 1/3" Fin, 7/8" Turnback	34
Return Air Filter Grilles,	
Stamped Steel	27
Stamped Steel, 1/3" Fin	28
Return Grilles,	
Baseboard	35
Baseboard, 1/3" Fin	36
Horizontal Blade	23
Stamped Steel	27
Stamped Steel, 1/3" Fin, 5/16" Turnback	26
Returns,	
Aluminum, Egg Crate	54
Cube Core, for T-Bar, Diffuser	55
Cube Core, for T-Bar, Insulated	55
Filter Grilles	55
Rods, Anode.	78
Saws	
Jab	73
Hack	73
Screwdrivers	74-75
Screws,	
Self Piercing	65
Self Tapping	65
Sidewall Supplies,	
Aluminum Horizontal Registers	49
Aluminum Horizontal/Vertical	50
Aluminum Vertical/Horizontal	49
Snips	73-74
Tanks, Thermal Expansion	78
Tapes,	
Duct	68
Electrical	68
PTFE Pipe Thread	68
Tape Measures	77
Thermocouples	78
Thermometers	72
Thermostats,	
Non-Programmable Thermostats	69
Programmable Thermostats	69
Tubes, Dip	78
Utility Knives & Blades	74
Valves,	
Ball	63-64
T&P Relief	78
Water Heater Drain	78
Wrenches,	
Adjustable	76
Torque	76
Engineering Data	79-109
Cross References	110-112
Index	113-118

Visit us Online:



PROSECTPRODUCTS.COM

Find your nearest sales associate, learn about special orders and regional quotation centers and access thousands of additional SKUs.

Visit a Branch:



PROSECTPRODUCTS.COM/support/where-to-buy

Order products from this catalog in person with the help of one of our highly qualified, knowledgeable associates.



FNW™

FNW.COM



Mirabelle®

MIRABELLEPRODUCTS.COM



M

MONOGRAM BRASS®

MONOGRAMBRASS.COM



PARK HARBOR®

PARKHARBORLIGHTING.COM



PROFLO

PROFLO.COM



PROSELECT™

PROSELECTPRODUCTS.COM



RAPTOR®

RAPTORTOOL.COM

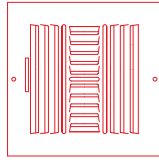

Find a location near you at
PROSELECTPRODUCTS.COM.

Contact your local PROSELECT
sales associate for information
on special orders and to see
all available inventory.

