

**OL-15**

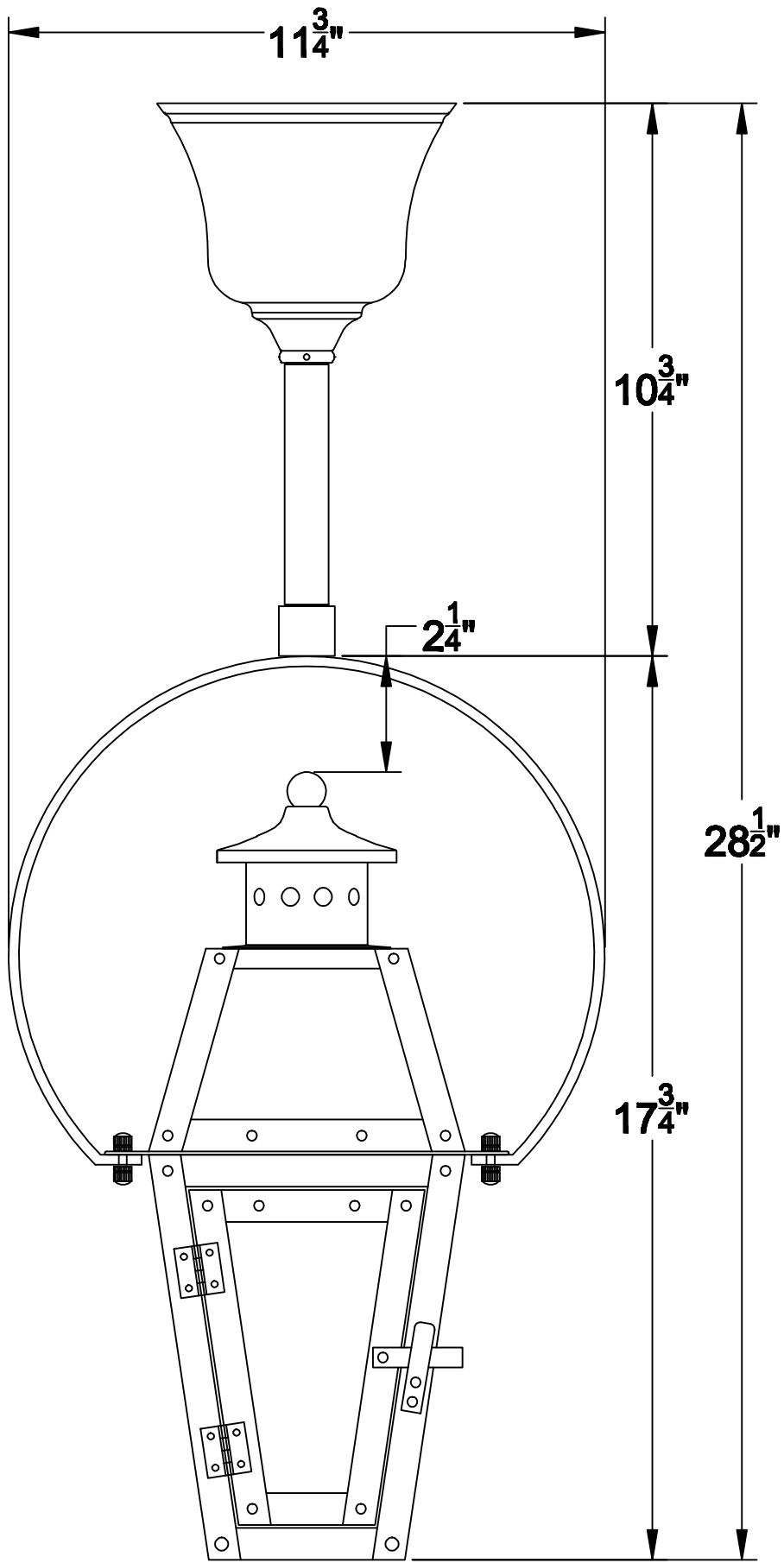

**HY-1**