

OA-33

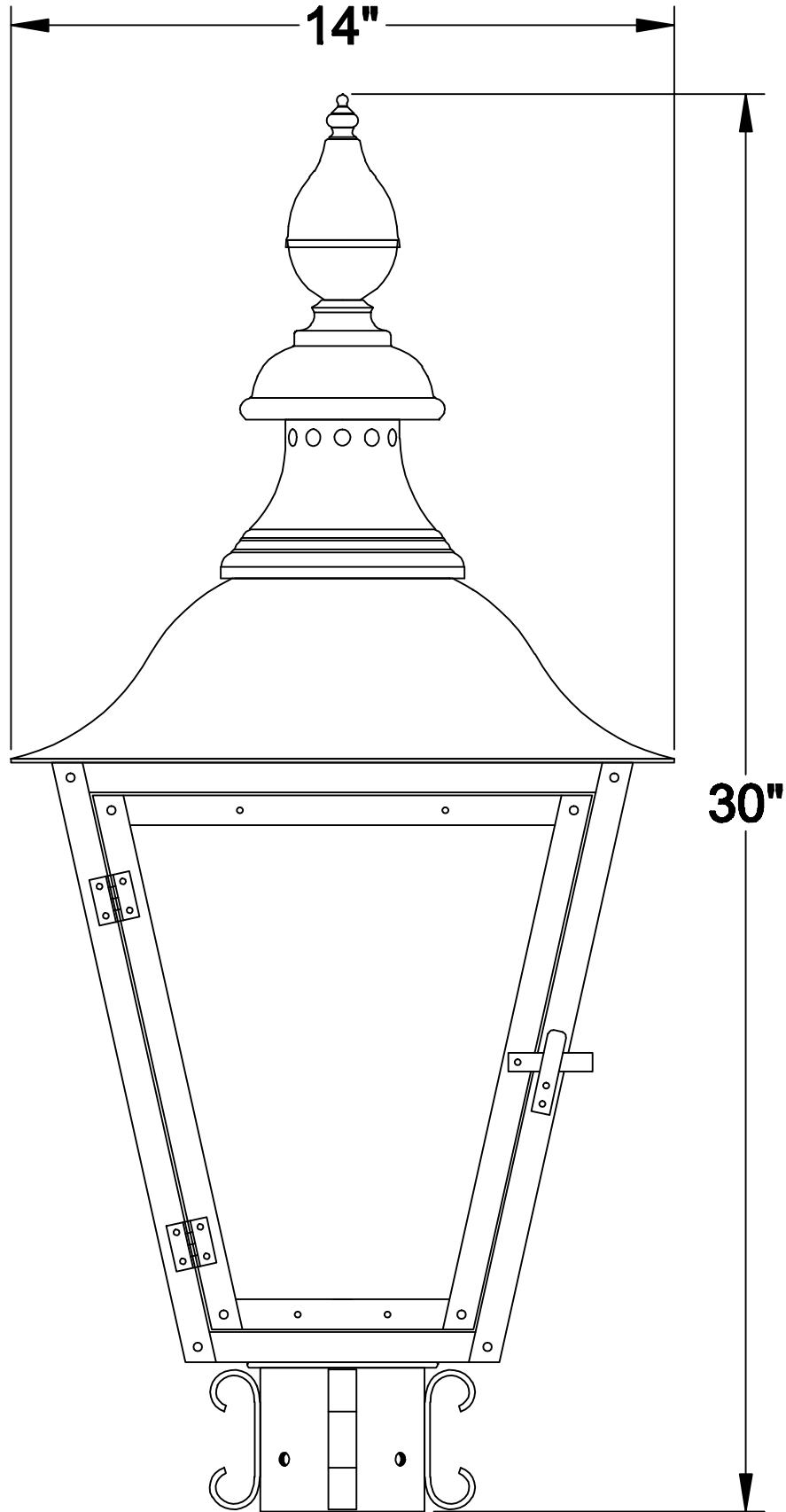

PM