

OA-33

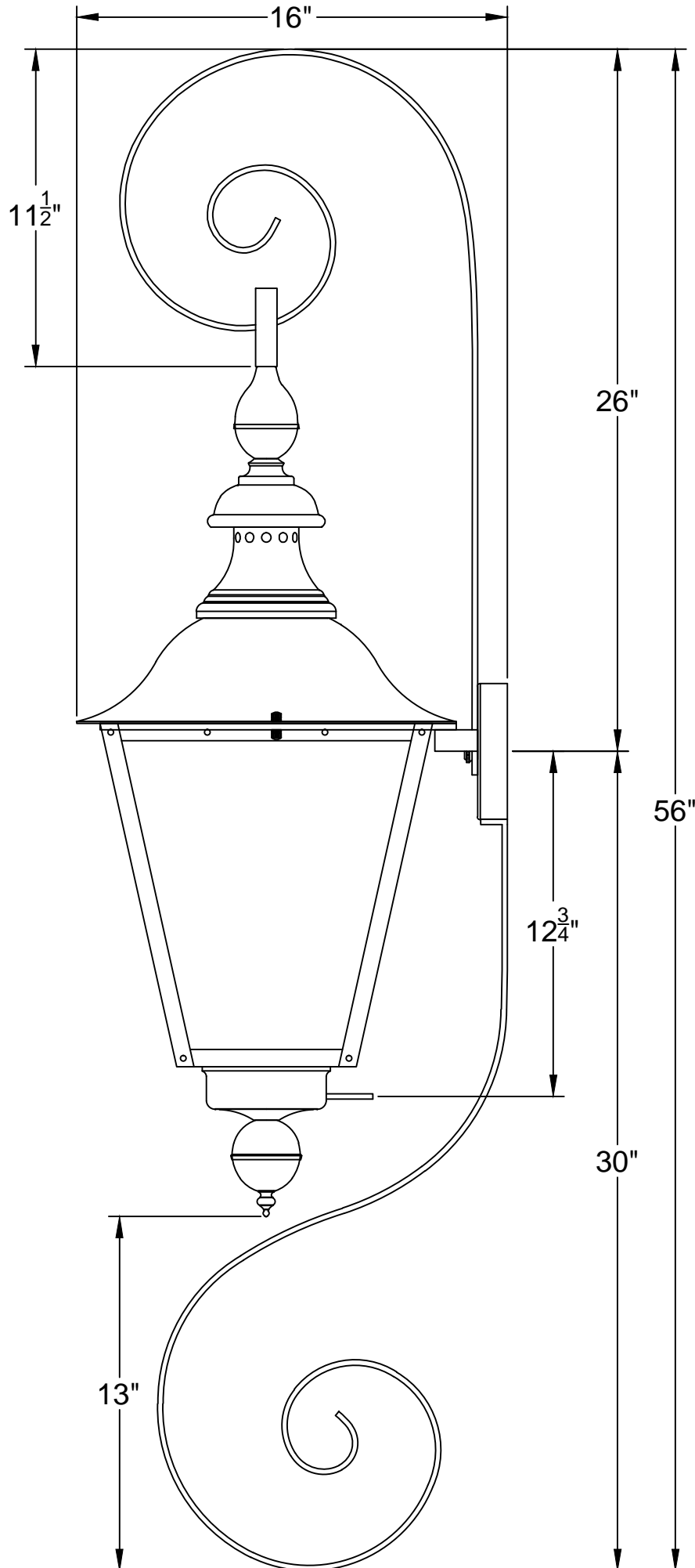

TS-3 BS-2