

CT-31

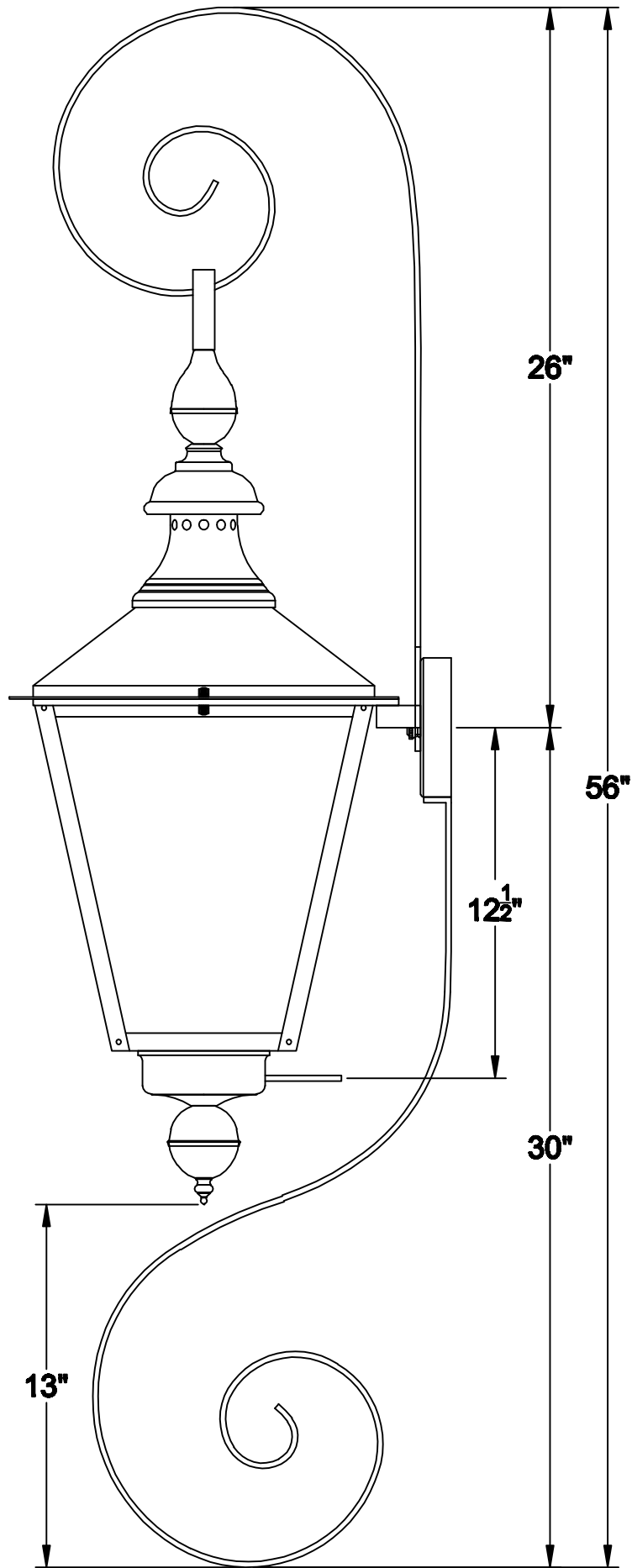

TS-3 BS-2