

Please go to [www. quozel. com](http://www. quozel. com) for product cleaning tips. Go to the **Care + Maintenance** selection.

**Tools Required:** Flathead screwdriver, Phillips screwdriver, pliers, wire cutters, wire strippers, electrical tape, safety glasses.

**Light Source:** Integrated LED 18W

**Compatible Dimmer Switches:** Lutron DVELV-300P or Lutron SELV-300P.

**Estimated Assembly Time:** 20-30 minutes

**Preparation:** Identify and inspect all parts before beginning installation. Check package content list and diagrams below to be sure all parts are present. If any parts are missing or damaged, do not attempt to assemble, install, or operate the fixture. Contact customer service for replacement parts.

## ⚠ Warnings and Cautions

Turn off electricity at circuit breaker or main fuse box before installation. Consult a licensed electrician if in doubt.

These instructions are provided for your safety. It is very important you read them completely before installing the fixture. We strongly recommend that a licensed, professional electrician perform the installation.

### Package Contents

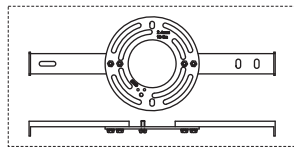

**A** Crossbar Assembly  
x 1

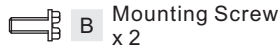

**B** Mounting Screw  
x 2

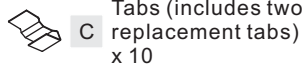

**C** Tabs (includes two replacement tabs)  
x 10

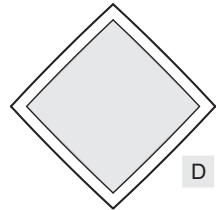

**D** Glass Panel  
x 4

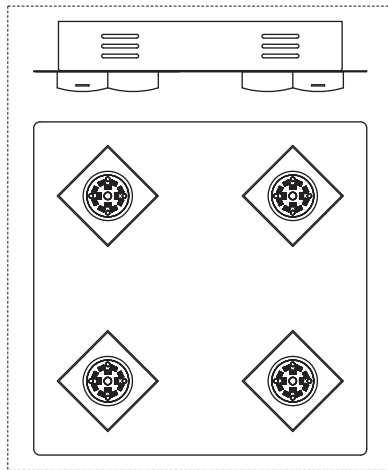

**E** Fixture Body  
x 1

### STEP 1 - Install Glass Panels

A. Place the Fixture Body (E) onto a flat working surface with the box side facing you. Attach Glass Panel (D) onto the box. Make sure the edge of the Glass Panel (D) and the edge of the box are parallel. Secure the Glass Panel (D) by pressing the Tabs (C) to the slot of the box and the surface of the Glass Panel (D).

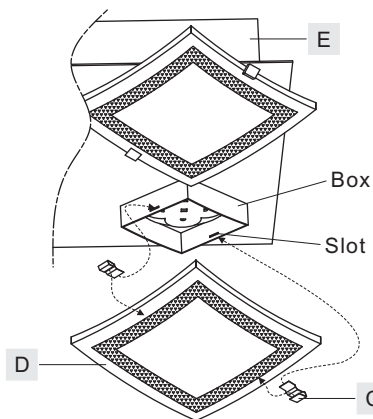
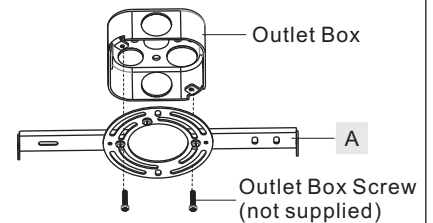

Figure 1

### STEP 2 - Attach Crossbar Assembly to Outlet Box

Figure 2

A. Attach the Crossbar Assembly (A) to Outlet Box and secure by threading Outlet Box Screws (not supplied) into the Mounting Holes on the Outlet Box. Tighten until snug.



### STEP 3 - Wire Connections

A. Wrap bare or green ground wire around green ground screw on the crossbar, no less than 2 inches from the end of the wire. Tighten the green ground screw.  
B. Use standard wire connectors (not included) to make all wire connections. Twist connectors until wires are tightly joined together. Wrap each connection with approved electrical tape and carefully stuff all the connected wires into the Outlet Box.

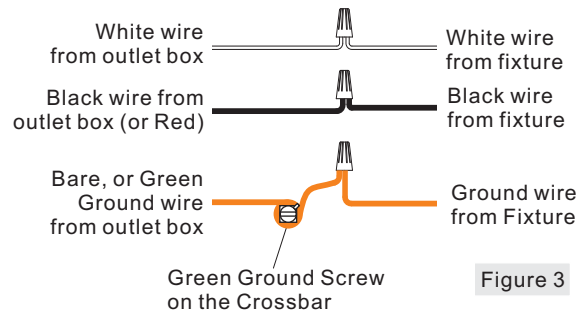

Figure 3

### STEP 4 - Attach Fixture Body to Crossbar

A. Fit excess cord and electrical wires in the ceiling canopy properly. Line up the holes on the side of the ceiling canopy to the mounting holes on the Crossbar Assembly (A). Secure them with Mounting Screws (B). Tighten until snug.

Your fixture is now assembled and ready to use. Enjoy!

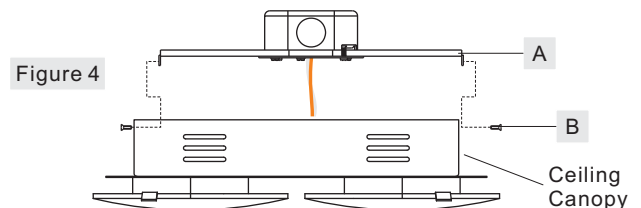

Figure 4

**Thank you for purchasing a Quoizel product.**  
**Need assistance with parts or assembly? Call Quoizel customer service at 1-800-645-3184**  
**or visit us on-line at [www. quozel. com](http://www. quozel. com)**

PCEP1612C

FINISH: POLISHED CHROME

NOTE: ALL DIMENSIONS ARE ROUNDED UP TO THE NEAREST 1/4"

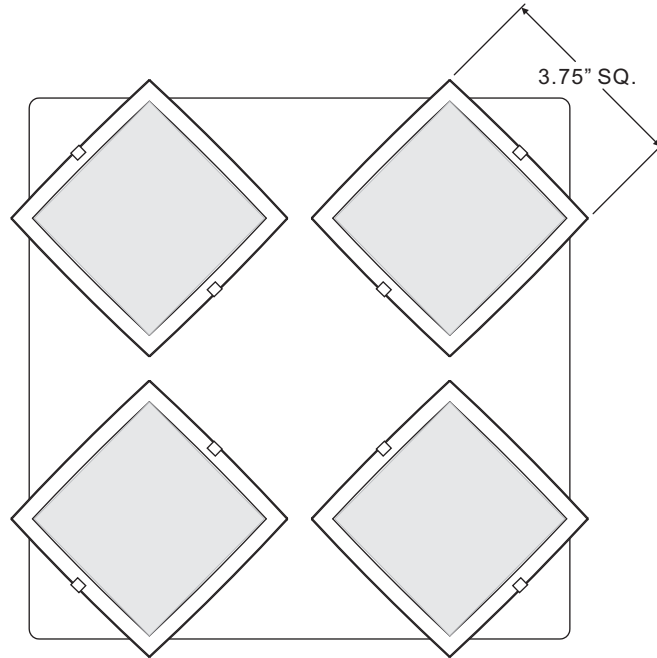
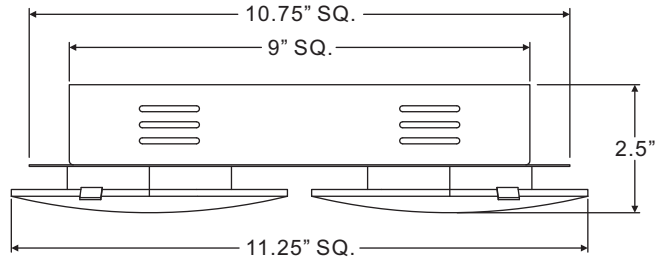
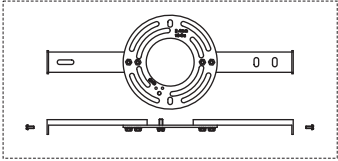

Thank you for purchasing a Quoizel product.  
Need assistance with parts or assembly? Call Quoizel customer service at 1-800-645-3184  
or visit us on-line at [www.quoizel.com](http://www.quoizel.com)