



INSTALLATION

PIONEER INDUSTRIES, INC.
 3325 S. Garfield Ave.
 Commerce, CA 90040
 (800) 338-9468
 www.pioneerind.com

Tools:



Adjustable Wrench Phillips screwdriver Plumbers Putty Teflon Tape Rags

Model Number: 2LG220



Warnings and Notes:

Check with local plumbing code requirements before installation.
 This product should be installed by a local listed plumber.
Do not use plumbers putty on threads.

Installation Steps:

Single Handle Pull-Out Kitchen Faucet

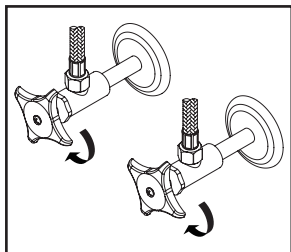

(1) Shut off the water supply. Remove old faucet. Clean mounting surface in preparation for new faucet.

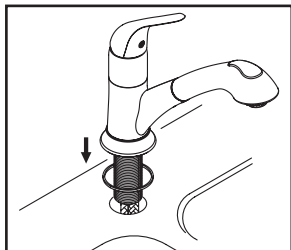

(2a) **For 1-Hole Installation:**- Make sure gasket is under escutcheon, slide escutcheon for 1-hole installation to the faucet shank. Insert faucet shank through mounting hole. Make sure spout swivel angle are even to the right and to the left.

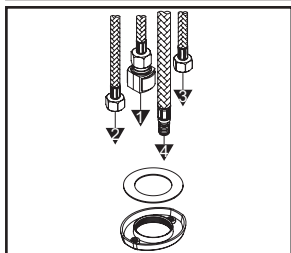

(2b) With flat side of the locknut facing down and the steel washer inside the locknut please follow the order as the drawing shows to insert flex hoses through the center hole of the locknut from underneath the sink.

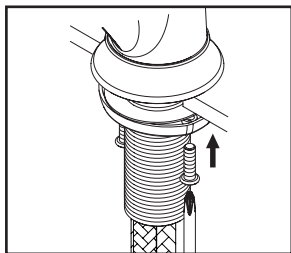

(2c) Thread locknut onto the faucet shank from underneath the sink. Position faucet to desired location from the top and hand-tighten locknut till it won't go further. Thread both screws on locknut and tighten screws on locknut with the help of a Phillips head screwdriver to secure faucet. (Note: Do not overtighten.)

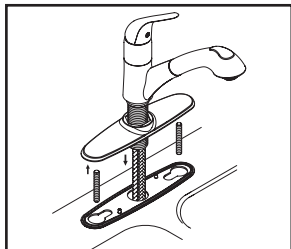

(3a) **For 3-Hole Installation:**- Thread mounting bolts to deck plate, apply plumbers putty under the base gasket, place faucet on the deck plate, make sure spout swivel angle are even to the right and to the left. Lead inlet & outlet flex hoses through center mounting hole to place faucet with deck plate and base gasket in position on the sink. Hand-tighten locknut to the faucet and tighten screws on locknut with the help of Phillips head screwdriver from underneath the sink.

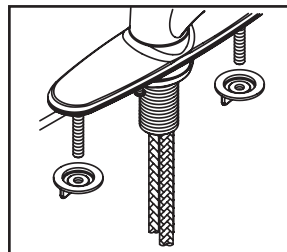

(3b) Thread and tighten both mounting nuts to mounting bolts from underneath the sink to secure faucet on the sink.

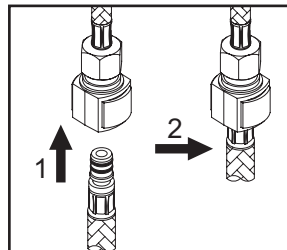

(4) Insert spray head hose into the end of quick connect adapter on the outlet hose, push until a "click" sound is heard. Pull down the spray head hose to test engagement.

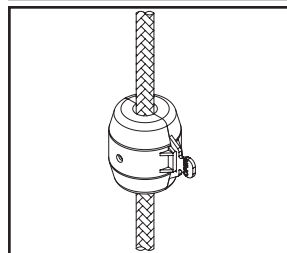

(5) Install weight on spray head hose. Adjust weight's position so the spray head can be retracted properly.

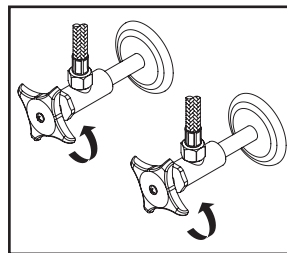

(6) Connect hot and cold inlet supply hoses to supply stops. For supply stop with 1/2" outlet connection, use 3/8" male to 1/2" female adapter for installation. Adapters are optional and are not provided with the faucet. Turn on both side supply stops to check any leaks.

Exploded Drawing

* Note: Please specify finish/color when ordering.

	ITEM #	DESCRIPTION
A	X-1200001*	Lever Handle
B	OP-420043*	Cap
C	OP-420042	Retainer Nut
D	X-3900001	Ceramic Disc Cartridge
E	X-4200156*	1.5 GPM Spray Head
F	X-4200197	Spray Hose
G	X-4200148	Spray Head Support
H	X-4200151*	Deck Plate & Base Gasket
I	X-4200152*	Escutcheon & Gasket
J	X-5200006	Mounting Bolts & Nuts
K	X-4200199	Quick Connect
L	OP-520015	Locknut with Screws
M	OP-420070	Weight
1	X-4900001	Hole Cover
2	X-4900002	Allen Screw
3	OP-420010	O-Ring
4	OP-420075	Washer

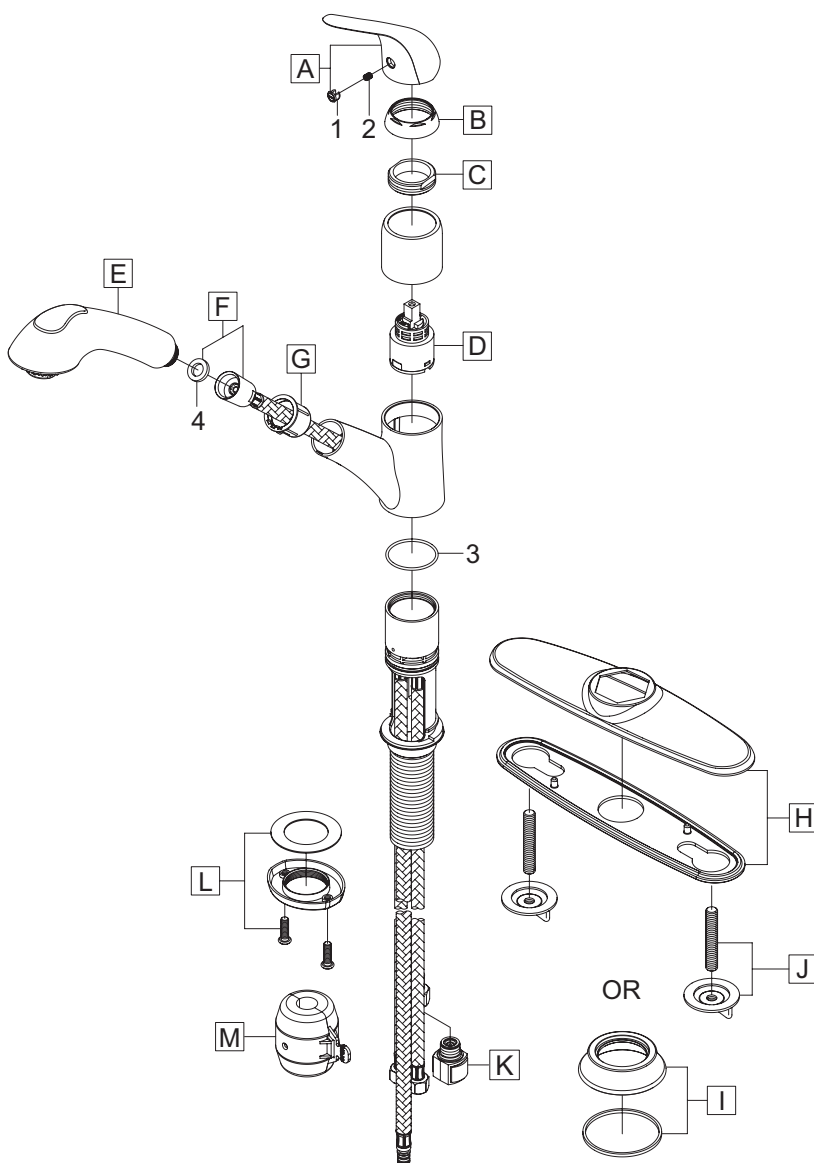

For more care information or trouble shooting inquiries about your Pioneer product, please call:
Pioneer Industries, Inc. (800) 338-9468
 Monday-Friday 8 AM to 8 PM EST (5 AM to 5 PM PST)
www.pioneerind.com