



PIONEER INDUSTRIES, INC.
 3325 S. Garfield Ave.
 Commerce, CA 90040
 (800) 338-9468
 www.pioneerind.com

INSTALLATION

Tools:



Adjustable Wrench



Plumbers Putty



Teflon Tape



Rags

Model Number: 3MO200

Warnings and Notes:

Check with local plumbing code requirements before installation.
 This product should be installed by a local listed plumber.
Do not use plumbers putty on threads.

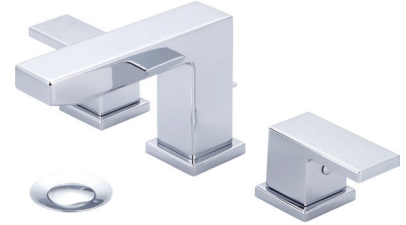

Installation Steps:

Two Handle Lavatory Widespread Faucet

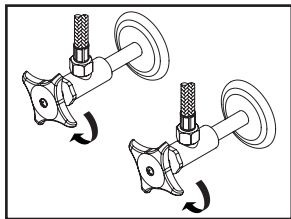

(1) Shut off the water supply. Remove old faucet. Clean mounting surface in preparation for new faucet.

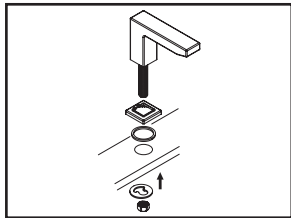

(2) Ensure gasket is under spout escutcheon, place spout escutcheon under the spout. Place spout in position on the sink, slide mounting bracket through spout shank from underneath the sink, thread mounting nut onto spout shank and tighten the mounting nut.

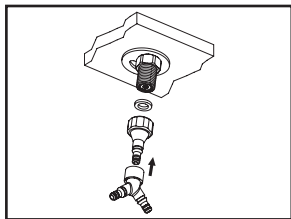

(3) With washer inside, thread and tighten quick connect adaptor to spout shank then insert Y connector into the end of quick connect adaptor on the inlet end of the spout shank. Push until a "click" sound is heard. Pull down the Y connector to test engagement.

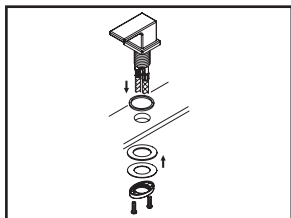

(4) Place cold and hot side valves in position on the sink, ensure handles operate in correct direction. From underneath the sink, hand-tighten locknut to the side valve. Position side valve to desired location from top. Tighten screws on locknut with the help of Phillips head screwdriver to secure side valve.

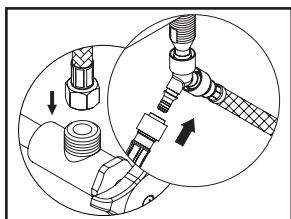

(5) Insert outlet hose of the side valve into the end of quick connect on the Y connector, push until a "click" sound is heard. Pull down the outlet hose of both side valves to test engagement.

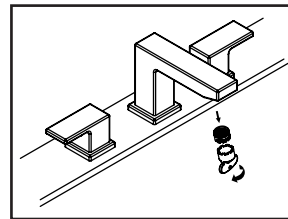

(6) Important: After installation is complete, remove the aerator. Turn on the water and allow both hot and cold water to run for at least one minute each. While water is running, check for leaks. Turn off the water and replace the aerator when finished.

Pop-up Drain Installation:

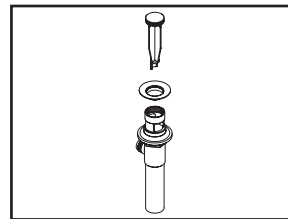

(1) Remove pop-up flange from body

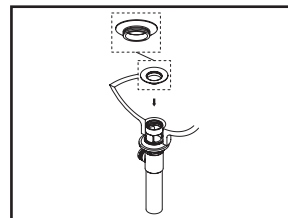

(2) Place a ring of plumbers putty on the bottom of flange.

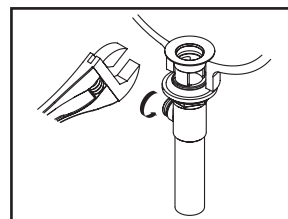

(3) Insert pop-up flange through drain hole and attach flange to the pop-up drain body. Apply Teflon tape on the threaded end of the tail piece and attach tail piece to the pop-up drain body. Ensure the pivot rod hole of the pop-up drain body faces towards the back of the sink. Tighten the locknut with the help of a wrench to secure the pop-up drain body.

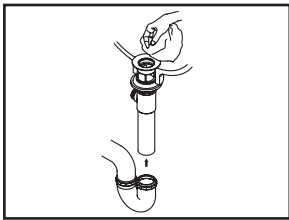

(4) Remove the excess plumber's putty. Connect the trap (check manufacturer's instructions for installation).

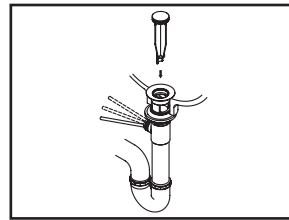

(6) Push pivot rod down, insert drain plug carefully. Test to ensure drain plug works properly.

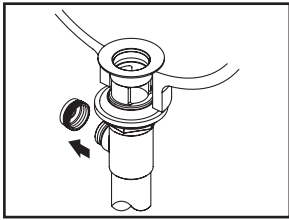

(5) Remove pivot rod nut from pop-up body, ensure the washers is in place, insert pivot rod, tighten pivot rod nut back to pop-up body.

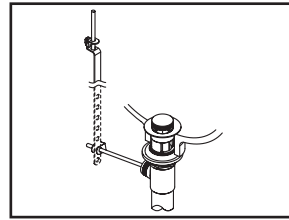

(7) Connect lift rod strap to pivot rod by using clip. Tighten the thumbscrew to connect lift rod strap to pop-up lift rod.

Exploded Drawing :

* Note: Please specify finish/color when ordering.

	ITEM #	DESCRIPTION
A	X-4300093	Red/Blue Index Button
B	X-1300020*	Metal Lever Handle
C	X-4300094*	Valve Escutcheon & Gasket
D	OP-530006	Valve Mounting Kit
E	X-4900022	Bonnet Nut
F	OP-330002C, H	Ceramic Stem-Cold, Hot
G	X-4900024	3/32" Allen Wrench
H	X-2300021*	Square Rigid Spout
I	X-5300003	Spout Mounting Kit
J	X-4300102	Quick Connect Adaptor
K	X-4300101	'Y' Connector
L	X-6300030*	Brass Pop-Up Drain Assembly
1	X-4900002	3/32" Allen Screw
2	X-4900044*	Hole Cover
3	OP-490062	1.2 GPM Aerator & Tool
4	X-4300091*	Spout Escutcheon and Gasket

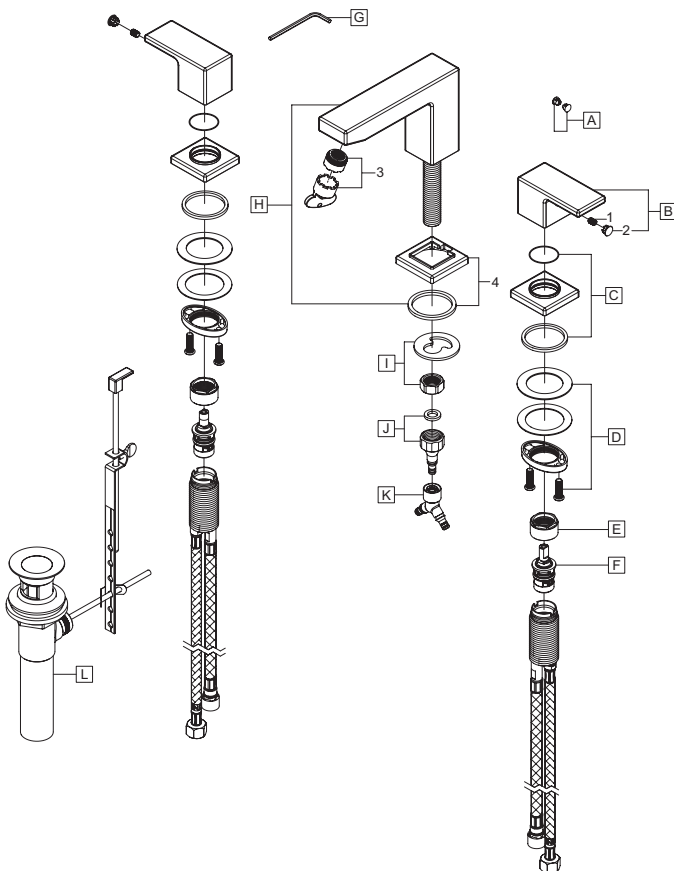

For more care information or trouble shooting inquiries about your Pioneer product, please call:
Pioneer Industries, Inc. (800) 338-9468
 Monday-Friday 8 AM to 8 PM EST (5 AM to 5 PM PST)
www.pioneerind.com