



INSTALLATION

PIONEER INDUSTRIES, INC.
 3325 S. Garfield Ave.
 Commerce, CA 90040
 (800) 338-9468
 www.pioneerind.com

Tools:



Adjustable Wrench



Plumbers Putty



Teflon Tape



Rags

Model Number: 3LG260H, 3LG260H-WD, 3LG262BH,
 3LG264H, 3LG264H-WD, 3LG264GH, 3LG264GH-WD



Warnings and Notes:

Check with local plumbing code requirements before installation.
 This product should be installed by a local listed plumber.
Do not use plumbers putty on threads.

Installation Steps:

Single Handle Lavatory Faucet

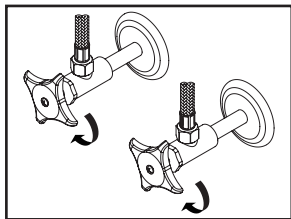

(1) Shut off water supplies. Remove old faucet. Clean mounting surface in preparation for new faucet.

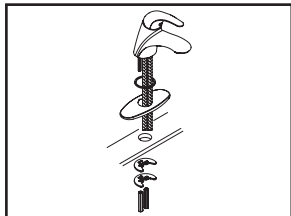

(2) Place gasket (for 1-hole installation) or deck plate (for 3-hole installation) on the bottom of the faucet. Lead inlet hoses through mounting hole. Slide mounting washer and mounting plate through mounting bolts from underneath the sink, tighten locknuts to mounting bolts.

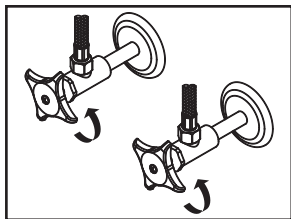

(3) Connect hot and cold inlet supply hoses to supply stops. For 1/2" connection; use 3/8" male to 1/2" female adapter for installation. Adapters are optional and not provided with the faucet. Turn on both sides of the supply stop.

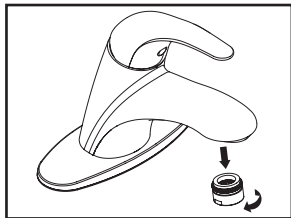

(4) Important: After installation is complete, remove aerator. Turn on the water and allow both hot and cold water to run for at least one minute each. While water is running, check for leaks. Turn off the water and replace aerator when done.

Pop-up Drain Installation:

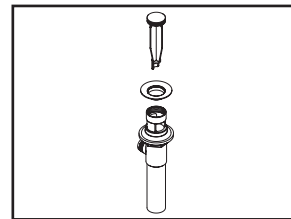

(1) Remove pop-up flange from body

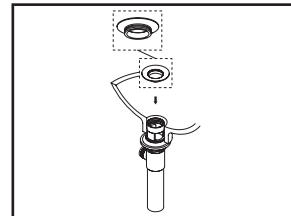

(2) Place a ring of plumbers putty on the bottom of flange.

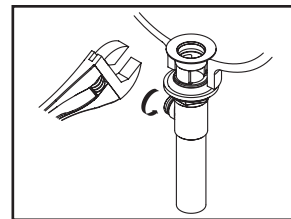

(3) Insert pop-up flange through drain hole and attach flange to the pop-up drain body. Apply Teflon tape on the threaded end of the tail piece and attach tail piece to the pop-up drain body. Ensure the pivot rod hole of the pop-up drain body faces towards the back of the sink. Tighten the locknut with the help of a wrench to secure the pop-up drain body.

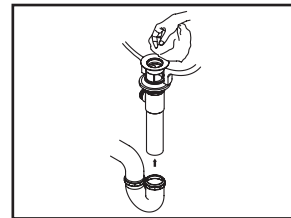

(4) Remove the excess plumbers putty. Connect the trap (check manufacturer's instructions for installation).

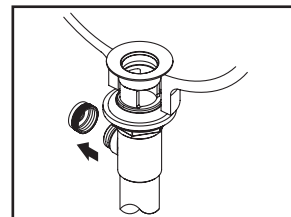

(5) Remove pivot rod nut from pop-up body, ensure the washers is in place, insert pivot rod, tighten pivot rod nut back to pop-up body.

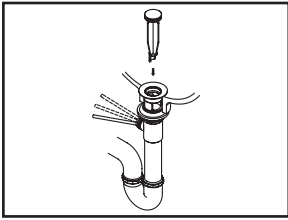

(6) Push pivot rod down, insert drain plug carefully. Test to ensure drain plug works properly.

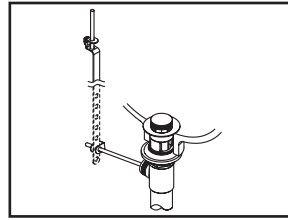

(7) Connect lift rod strap to pivot rod by using clip. Tighten the thumbscrew to connect lift rod strap to pop-up lift rod.

Exploded Drawing :

* Note: Please specify finish/color when ordering.

	ITEM #	DESCRIPTION
A	X-1300001*	Lever Handle
B	X-4900017*	Cap
C	X-4900018	Retainer Nut
D	X-3900003	Ceramic Disc Cartridge
E	X-4300024*	Hole Cover (For "4" Suffix)
F	OP-490065*	1.2 GPM Aerator
G	X-4200076	Gasket
H	X-5300007	Mounting Kit
I	X-4300038*	Deck Plate (For "WD" Suffix)
J	X-6300001*	Brass Pop-Up Drain Assembly (For "0" Suffix)
K	X-6300023*	50/50 Pop-Up Drain Assembly (For "2" Suffix)
L	X-6300002*	Brass Grid Strainer (For "G" Suffix)
1	X-4900001	Red/Blue Index Button
2	X-4900002	Allen Screw

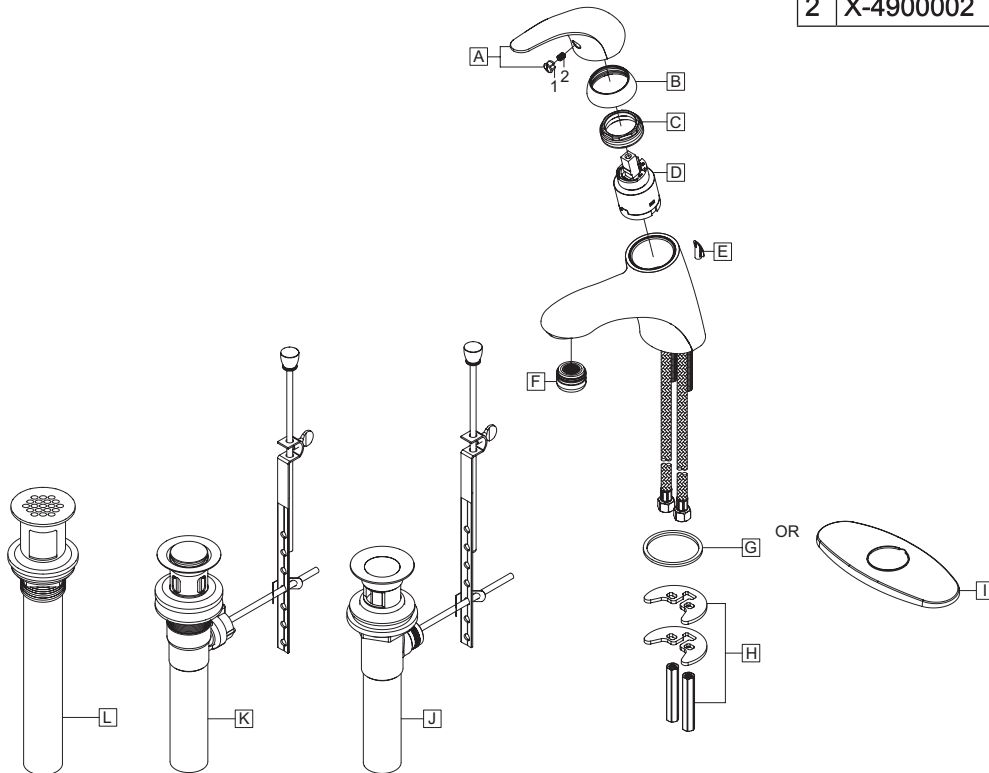

For more care information or trouble shooting inquiries about your Pioneer product, please call:
Pioneer Industries, Inc. (800) 338-9468
 Monday-Friday 8 AM to 8 PM EST (5 AM to 5 PM PST)
www.pioneerind.com