



PIONEER INDUSTRIES, INC.
 3325 S. Garfield Ave.
 Commerce, CA 90040
 (800) 338-9468
 www.pioneerind.com

INSTALLATION

Tools:



Adjustable Wrench



Plumbers Putty



Teflon Tape



Rags

Model Number: 3LG160, 3LG160B, 3LG160H,
 3LG161, 3LG161G, 3LG170, 3LG170B, 3LG171,
 3LG180, 3LG180B, 3LG181



Warnings and Notes:

Check with local plumbing code requirements before installation.
 This product should be installed by a local listed plumber.
Do not use plumbers putty on threads.

Installation Steps:

Single Handle Lavatory Faucet

Pop-up Drain Installation:

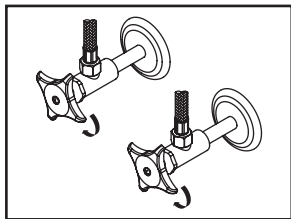

(1) Shut off water supplies. Remove old faucet. Clean mounting surface in preparation for new faucet.

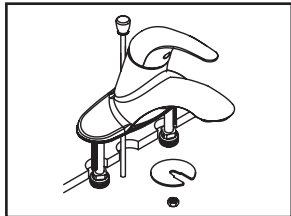

(2) Place the faucet in position on the sink. Apply plumbers putty under the base gasket. Place washer and tighten with locknut.

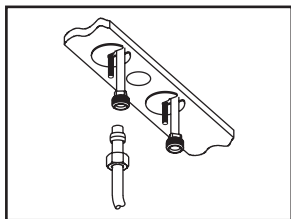

(3a) When using ball-nose flexible supplies to connect faucet to water supply lines, slip coupling nut onto flexible supply. Ball-nose coupling will go partially into shank. Tighten coupling nut (DO NOT OVER TIGHTEN). Install opposite end according to manufacturer's instruction for both tubes.

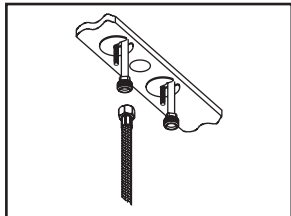

(3b) When using stainless steel braided faucet supply hose, this faucet requires one end of the supply hose to have a 1/2" female IPS connection. The other end of this supply hose must match the thread on the water supply valve under your sink. Once you've identified the required size, carefully follow the manufacturer's installation instructions for each hose.

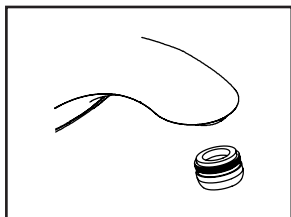

(4) Important: After installation is complete, remove aerator. Turn water supply on and allow both hot and cold water to run at least one minute each. While water is running, check for leaks. Turn off water and replace aerator.

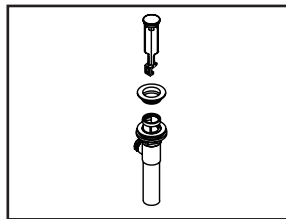

(1) Remove pop-up flange from body

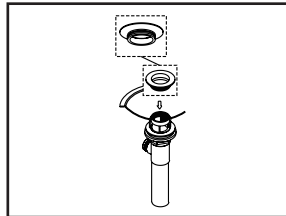

(2) Place a ring of putty on the bottom of flange.

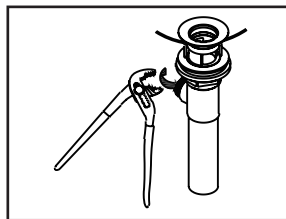

(3) Insert pop-up flange through drain hole and attach flange to body. Ensure the pop-up outlet faces towards the back of the sink. Tighten the locknut securely with a wrench. Do not overtighten.

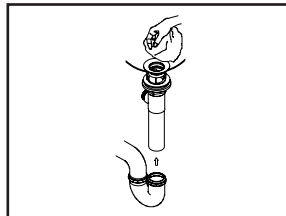

(4) Remove the excess putty. Connect the trap (check manufacturer's instructions for installation)

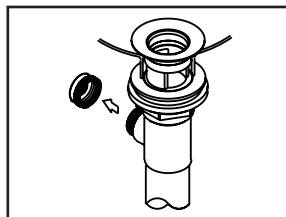

(5) Remove pivot rod nut from pop-up body, ensure the washers is in place, insert pivot rod, tighten pivot rod nut back to pop-up body.

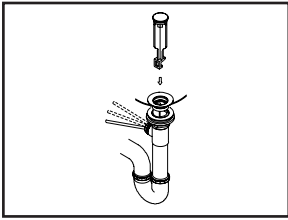

(6) Push pivot rod down, insert drain plug carefully. Test to ensure drain plug works properly.

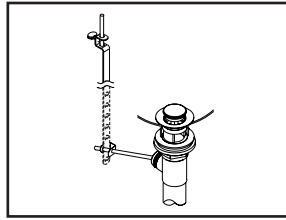

(7) Connect lift rod strap to pivot rod by using clip. Tighten the thumbscrew to connect lift rod strap to pop-up lift rod.

Exploded Drawing :

* Note: Please specify finish/color when ordering.

	ITEM #	DESCRIPTION
A	X-1300001*	Legacy Lever Handle (For 3LG160, 3LG161, 3LG161G, 3LG160H, 3LG160B)
B	X-1300002*	Legacy Loop Handle (For 3LG170, 3LG171, 3LG170B)
C	X-1300003	Legacy Acrylic Ball Handle (For 3LG180, 3LG180B, 3LG181)
D	X-4900017*	Cap
E	X-4900018	Locknut
F	X-3900003	Ceramic Disc Cartridge
G	X-4900081*	1.5 GPM Aerator
H	X-4300003	Base Gasket
I	X-5300001	Mounting Kit
J	X-4900004	Supply Nut
K	X-6300001*	Brass Pop-Up Drain Assembly (3LG160, 3LG160H, 3LG160B, 3LG170, 3LG170B, 3LG180, 3LG180B)
L	X-6300002*	Brass Grid Strainer (3LG161G)
1	X-4900001	Red/Blue Index Button
2	X-4900002	Allen Screw
3	X-4300004	Index Button (3LG180, 3LG180B, 3LG181)
4	X-4300005	Screw (3LG180, 3LG180B, 3LG181)

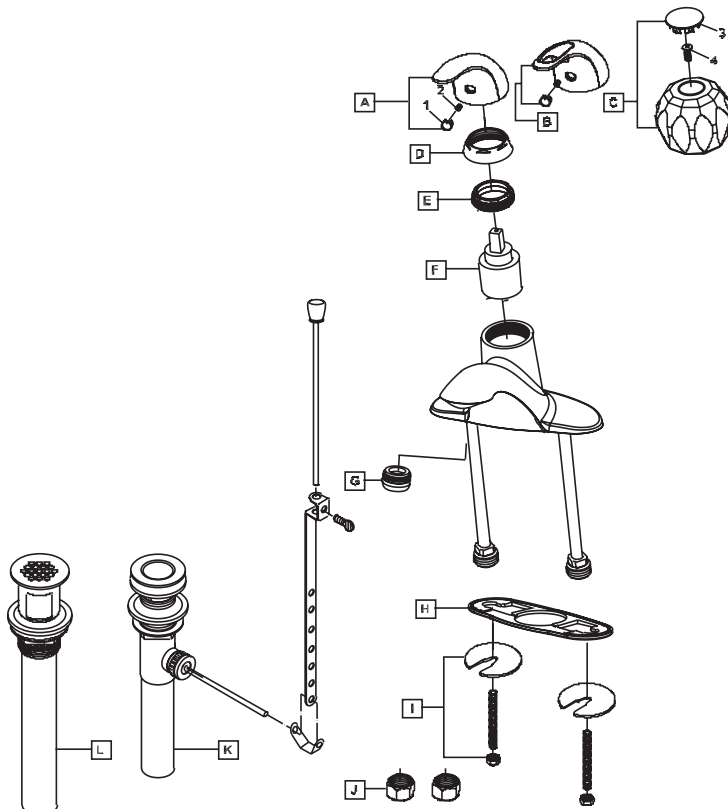

For more care information or trouble shooting inquiries about your Pioneer product, please call:
Pioneer Industries, Inc. (800) 338-9468
 Monday-Friday 8AM to 8PM EST (5AM to 5PM PST)
www.pioneerind.com