



ENGINEERING EXCELLENCE

Premium Series #2PM440 SPECIFICATION SHEET

DESCRIPTION

- Two Handle Wall Mount Faucet
- Metal Cross Handles
- Hi-Tubular Spout
- 9-1/4" Reach
- Ceramic Disc Cartridges
- 2-Hole 3-1/2" to 8-1/2" Installation
- 1/2" Eccentric Connections

FINISHES

- PC Polished Chrome



#2PM440 SHOWN

FLOW

- Aerator Limited to 1.5 GPM

STANDARDS APPLICABLE

- ASME A112.18.1
- ANSI A117.1
- ANSI / NSF 61, SECTION 9
- CUPC / IAPMO LISTED
- CONTAINS NO MORE THAN 0.25% WEIGHTED AVERAGE LEAD CONTENT

Model #: _____

Specific Features: _____

Project Name: _____

Submitted For: _____

Model	Description	Finishes	
#2PM440	Two Handle Wall Mount Faucet	<input type="checkbox"/> PC	<input type="checkbox"/> Other____



ENGINEERING EXCELLENCE

Pioneer:1-800-338-9468
 Commerce, CA 90040
 www.pioneerind.com
 Pioneer Industries, Inc. © 2018

DMSP2PM440/REV. 12 2018

Page 1 of 2

Installation Note:

Please refer to Installation Guide For this Product.

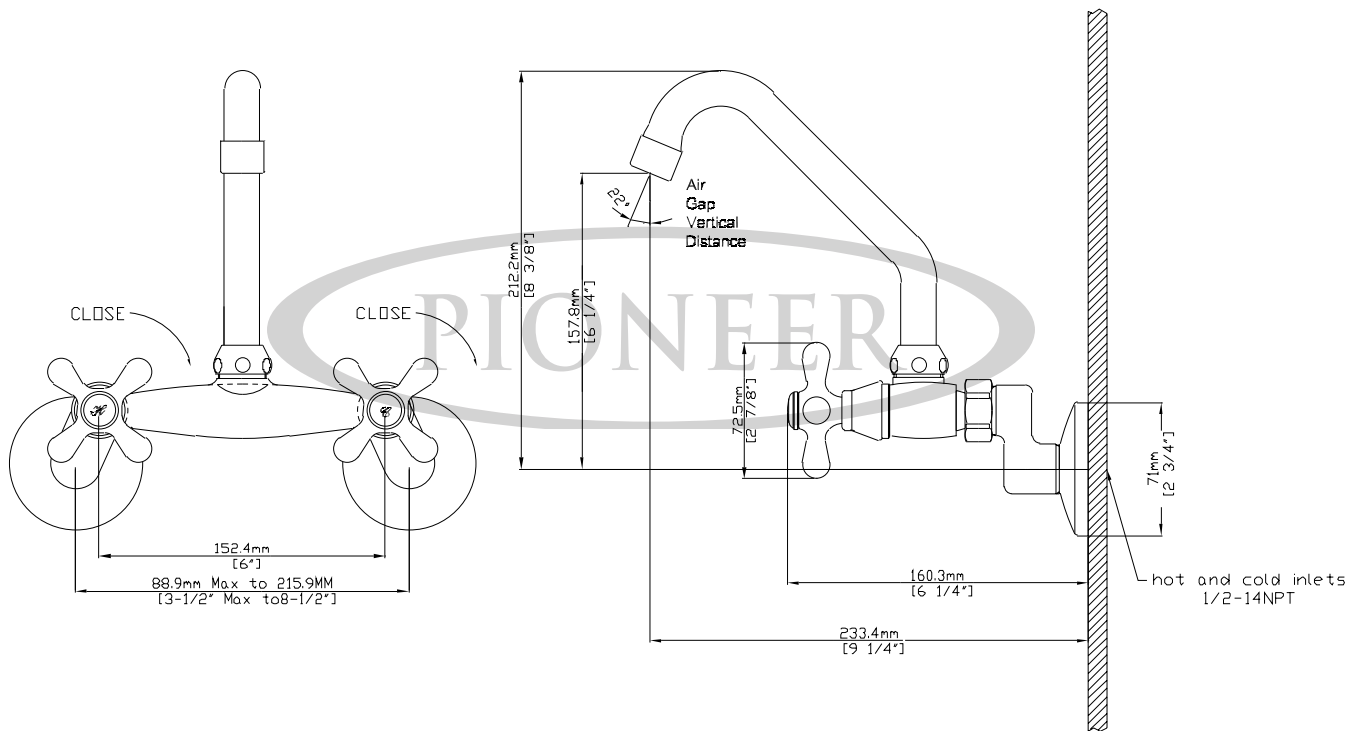

Product Diagram



ENGINEERING EXCELLENCE

Pioneer: 1-800-338-9468
 Commerce, CA 90040
 www.pioneerind.com
 Pioneer Industries, Inc. © 2018