



INSTALLATION

PIONEER INDUSTRIES, INC.
3325 S. Garfield Ave.
Commerce, CA 90040
(800) 338-9468
www.pioneerind.com

Tools:



Adjustable Wrench



Plumbers Putty



Teflon Tape



Rags

Model Number: 2LG160, 2LG160B, 2LG160H, 2LG161, 2LG161B, 2LG161H, 2LG162, 2LG170, 2LG170B, 2LG171, 2LG172



Warnings and Notes:

Check with local plumbing code requirements before installation.
This product should be installed by a local listed plumber.
Do not use plumbers putty on threads.

Installation Steps:

Single Handle Kitchen Faucet

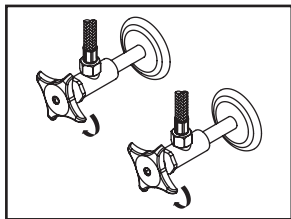

(1) Shut off water supplies. Remove old faucet. Clean mounting surface in preparation for new faucet.

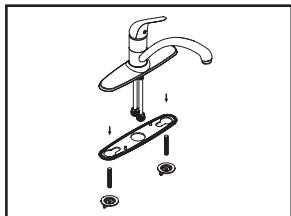

(2) Apply adequate plumbers putty along the boundary of base gasket. Thread mounting bolts to the bottom of faucet. Align faucet with mounting holes and place faucet on the sink, thread locknut onto mounting bolts from underneath of the sink, hand tighten locknuts.

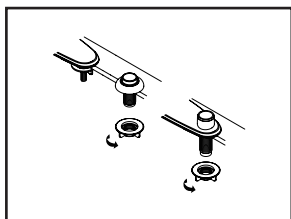

(3) For faucet with side spray, place spray holder on mounting hole or on faucet deck plate for side spray on deck type. Tighten locknut from underneath of the sink.

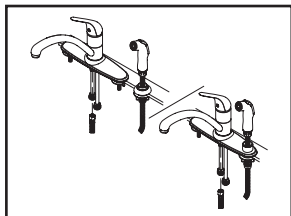

(4) Attach side spray to side spray hose, insert side spray hose down through spray holder; attach side spray hose to faucet side spray port, hand tighten securely.

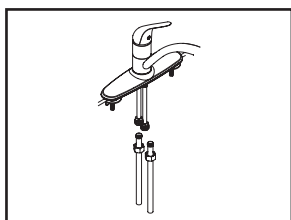

(5a) when using ball-nose flexible supply tubes to connect faucet to water supply valves, slip coupling nut onto flexible supply. Ball-nose coupling will go partially into inlet tube. Tighten coupling nut (DO NOT OVERTIGHTEN). Install opposite end according to manufacturer's instruction for both tubes.

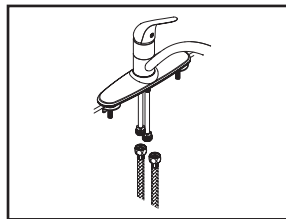

(5b) when using stainless steel braided faucet supply hose; this faucet requires one end of the supply hose to have a 1/2" female IPS connection. The other end of this supply hose must match the thread on the water supply valve under your sink. Once you've identified the required size, carefully follow the manufacturer's installation instructions for each hose.

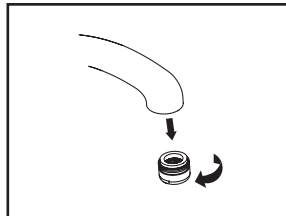

(6) Important: After installation is complete, remove aerator. Turn water supplies on and allow both hot and cold water to run at least one minute each. While water is running, check for leaks. Turn off water and replace aerator.

Exploded Drawing :

* Note: Please specify finish/color when ordering.

	ITEM #	DESCRIPTION
A	X-1200001*	Legacy Lever Handle (For 2LG16X)
B	X-1200002*	Legacy Loop Handle (For 2LG17X)
C	X-4200001*	Cap
D	X-4200002	Retainer Nut
E	X-3900001	Ceramic Disc Cartridge
F	X-4200003	Spout Gasket
G	X-2200001*	Legacy Spout
H	X-4200004	O-Ring
I	X-4200007	Diverter Piston (For 2LG161,2LG161H, 2LG162, 2LG171, 2LG172)
J1	X-4200005*	Deck Plate (For 2LG160, 2LG160H, 2LG161H, 2LG170, 2LG171)
J2	X-4200010*	Deck Plate (2LG162, 2LG172)
K	X-4200006	Base Plate
L	X-5200006	Mounting Kit
M	X-4900004	Supply Nut (For 2LG160, 2LG161, 2LG162, 2LG170, 2LG171, 2LG172)
N1	X-4200008*	Side Spray Assembly (For 2LG161, 2LG161H, 2LG171)
N2	X-4200009*	Side Spray Assembly (For 2LG162, 2LG172)
1	X-4900001	Button
2	X-4900002	Allen Screw
3	X-4900081*	1.5 GPM Aerator

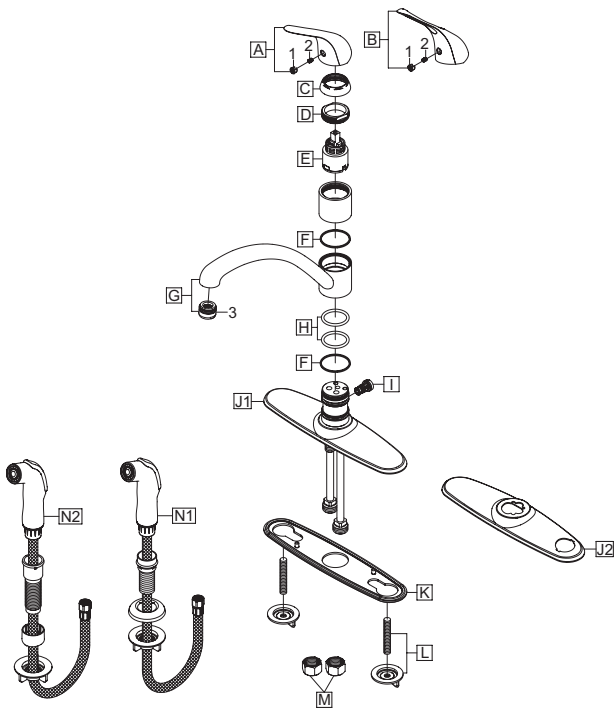

For more care information or trouble shooting inquiries about your Pioneer product, please call:
Pioneer Industries, Inc. (800) 338-9468
 Monday-Friday 8AM to 8PM EST (5AM to 5PM PST)
www.pioneerind.com