

Installation Support • Soporte de Instalación • Support d'Installation

Personal Assistance, Product Specs, & "How-to" Questions:

Asistencia personal, especificaciones del producto y preguntas sobre "cómo hacerlo":

Aide personnelle, spécifications du produit et questions « pratico-pratiques » :

1-800-PFAUCET (732-8238)

pfisterfaucets.com/support

Installation Videos Available
Videos de instalación a disposición
Vidéos d'installation disponibles



pfisterfaucets.com/videos

▲ WARNING / ADVERTENCIA / AVERTISSEMENT

To reduce the risk of injury or property damage, read all instructions before installing product. Wear safety goggles. Product must be installed in accordance with all state & local plumbing & building codes. Call a professional if you are uncertain about installing this product.

This product has been designed for use with the Pfister® OX8 Series Pressure Balancing Valve. It will not work with any other product valve. Please review the OX8 valve installation instructions before installing this product.

Para disminuir el riesgo de lesiones o daños a la propiedad, lea todas las instrucciones antes de instalar el producto. Utilice gafas de seguridad. El producto deberá instalarse de acuerdo con la normativa de plomería y construcción estatal y local. Llame a un profesional si no está seguro sobre cómo instalar este producto. Este producto ha sido diseñado para usar con la válvula de equilibrio de presión de la Serie OX8 de Pfister®. No funcionará con cualquier otra válvula. Revise las instrucciones de instalación de la válvula OX8 antes de instalar este producto.

Pour réduire le risque de blessures ou de dommages, lire toutes les instructions avant d'installer l'appareil. Porter des lunettes de sécurité. Il faut installer l'appareil en respectant tous les codes de construction et de plomberie locaux et d'État. Appelez un professionnel si vous n'êtes pas certain de la façon d'installer cet appareil. Cet appareil a été conçu pour être utilisé avec la valve d'équilibrage de pression Pfister® OX8. Il ne fonctionnera pas avec la valve d'un autre appareil. Veuillez lire les instructions d'installation de la valve OX8 avant d'installer ce produit.

Required Tools Herramientas necesarias Outils nécessaires



Teflon Tape
Cinta de teflón
Ruban en téflon



Adjustable Wrench
Llave ajustable
Clé réglable

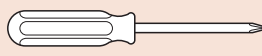

Phillips Screwdriver
Destornillador de estrella
Tournevis Phillips



Safety Goggles
Gafas de seguridad
Lunettes de sûreté

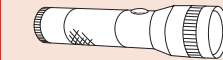

Flashlight
Linterna
Lampe-torche



Cloth
Paño
Chiffon

Parts in the Box Piezas en la caja Pièces dans la boîte



A



B



C



D

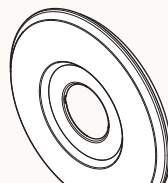

E

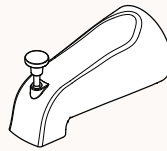

F



G

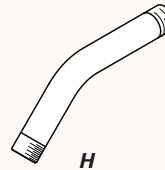

H



J

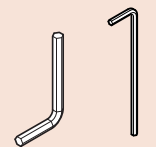

Supplied Hex Wrench
Proveído Llave hexagonal
Fourni Clé hexagonale

1 Turn Off Water Supply • Cierre el suministro de agua • Couper l'alimentation en eau

Locate the water supply inlets & shut off the water supply valves. These are usually found near the water meter. If you are replacing an existing unit, remove the old unit & clean mounting surface thoroughly.

Ubique las entradas del suministro de agua y cierre las válvulas de suministro. Estas se encuentran generalmente cerca del medidor de agua. Si reemplaza una unidad existente, retírela y limpie completamente la superficie de montaje.

Repérez les entrées d'alimentation d'eau et fermez les robinets d'arrêt. Ils sont normalement trouvés près du compteur d'eau. Si vous remplacez un appareil existant, enlevez le vieil appareil et nettoyez soigneusement la surface de montage.

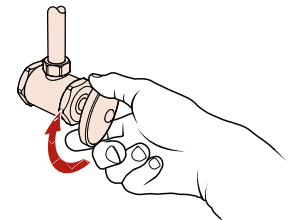

2 Plasterguard Options

Opciones para cubierta protectora para yeso

Options de para-plâtre

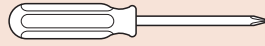

Phillips Screwdriver
Destornillador de estrella
Tournevis Phillips

No Parts Required for This Step
No se necesitan piezas para este paso
Aucune pièce nécessaire pour cette étape

Reference • Referencia • Référence

Tub and Shower Dimensions
Dimensiones de la bañera y la ducha
Dimensions baignoire et douche

Shower Only Dimensions
Dimensiones de la ducha solamente
Dimensions de la douche seulement

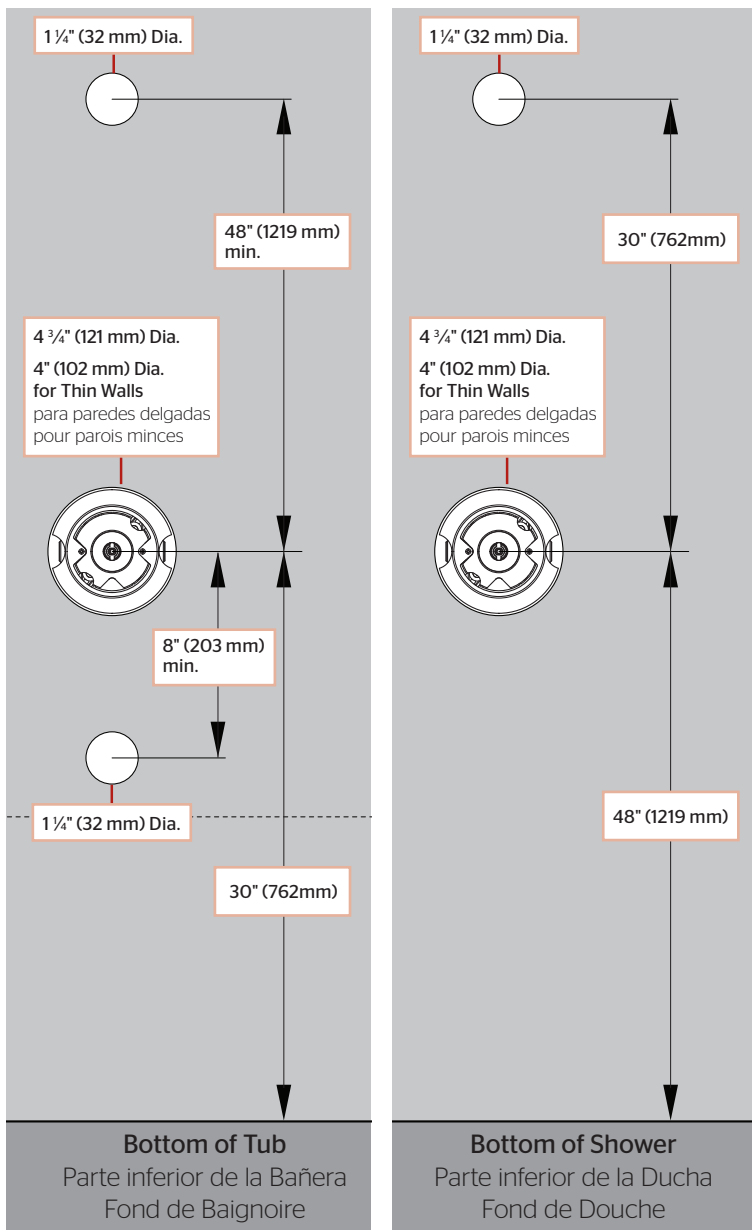

2A Thin Wall Installation (1 3/8" Max) Instalación en pared delgada (35 mm) Installation avec mur mince (35 mm)

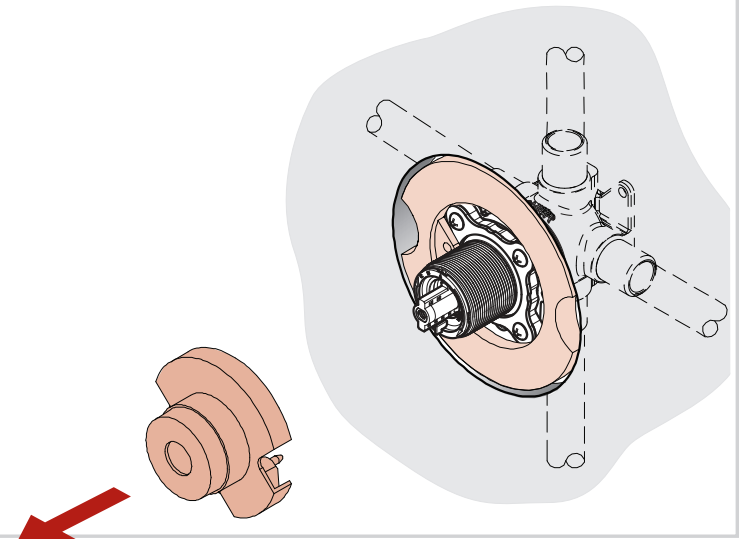

2A Thick Wall Installation (2 3/4" Max) Instalación en pared gruesa (41 mm - 70 mm) Installation avec mur épais (41 mm - 70 mm)

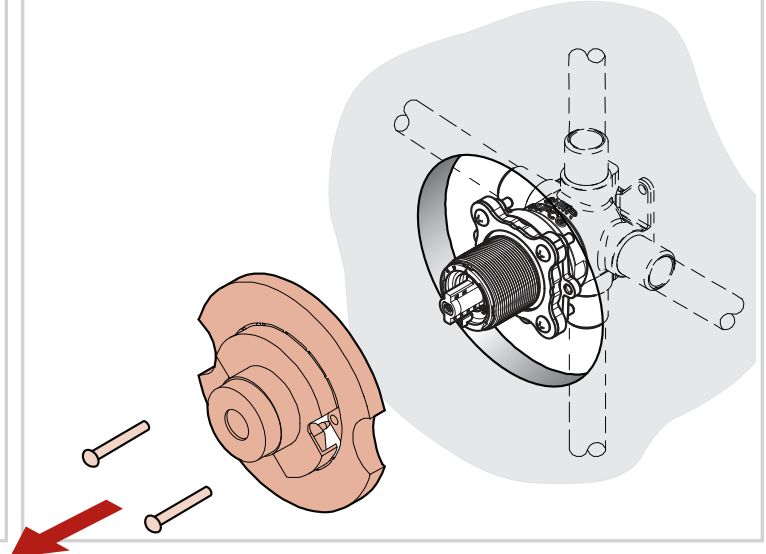

3 Install Retainer and Stem - Instale el anillo de retención y el tallo - Installez retenue et la tige

No Tools Required for This Step
No se necesitan herramientas para este paso
Aucun outil n'est nécessaire pour cette étape

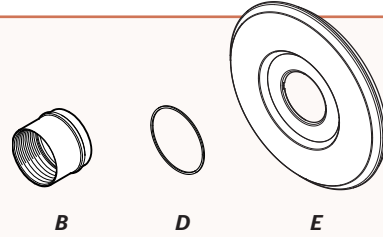

4A

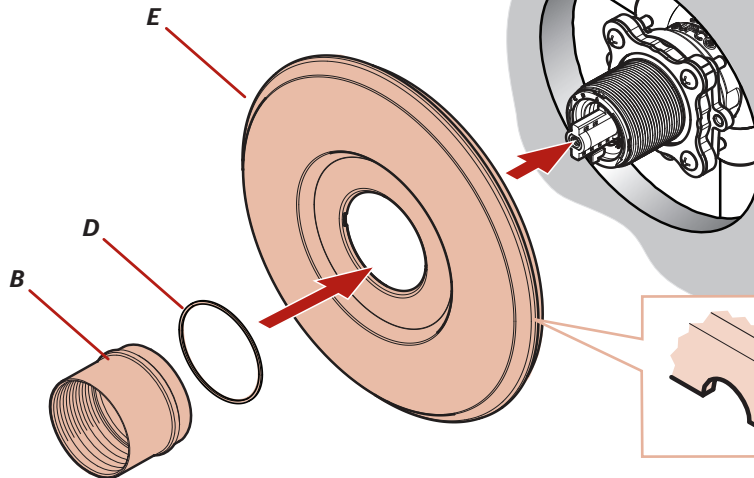

Groove on bottom.

Estría en la base.
Rainure vers le bas.

4 Install Flange and Handle - Instale la brida y el mango - Installez la bride et gérer



Supplied Hex Wrench
Proveído Llave hexagonal
Fourni Clé hexagonale



A

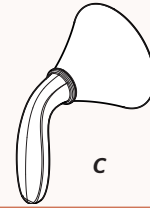

C

4A

Extension Kit 970-089 offers an additional 7/8" if valves are roughed in too deep.

Kit de Extensión de 970-089 ofrece un adicional de 7/8" si la válvula se desbastada demasiado dentro al pared.
970-089 kit d'extension fournit un supplément de 7/8" si la vanne est coupée trop loin dans le mur.

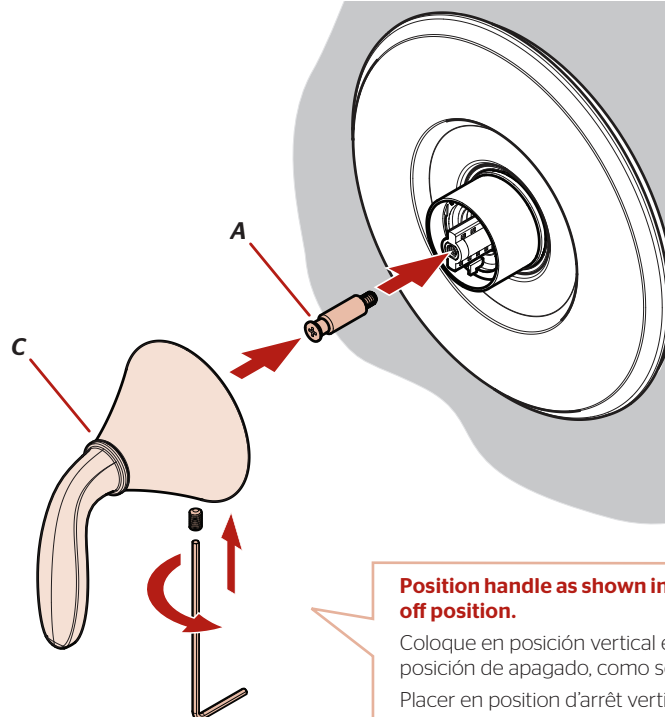

Position handle as shown in vertical off position.

Coloque en posición vertical en la posición de apagado, como se muestra.
Placer en position d'arrêt vertical comme illustré.

5

Connect Shower Arm & Spout

Conecte el brazo de la ducha y el surtidor

Branchez le bras de douche & le bec



Teflon Tape
Cinta de teflón
Ruban en téflon

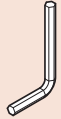

Supplied Hex Wrench
Proveído Llave hexagonal
Fourni Clé hexagonale

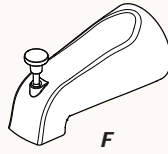

F



G

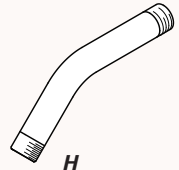

H

5A

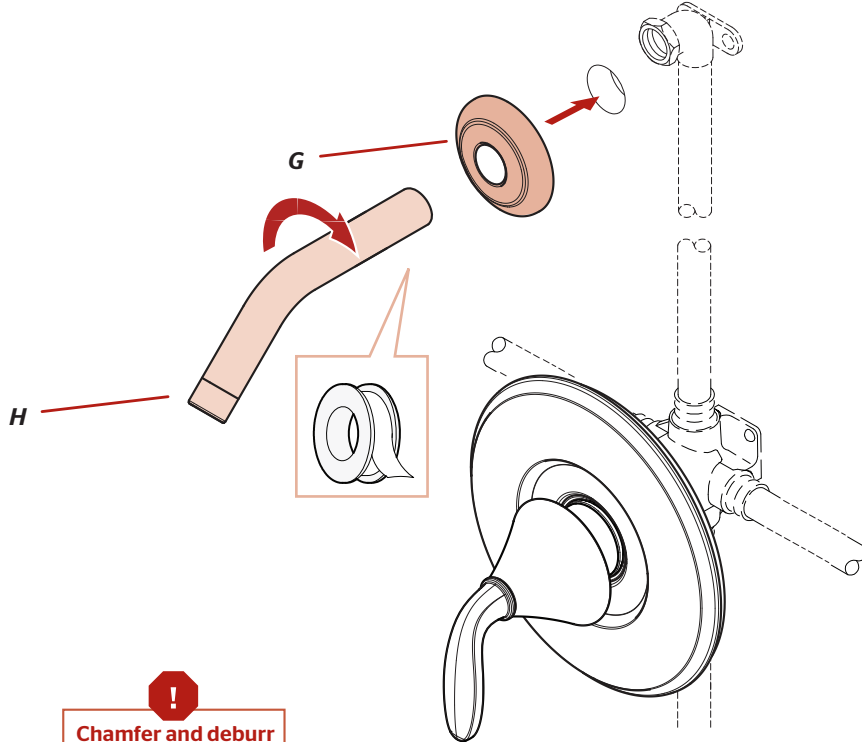

Chamfer and deburr

Chaflán y desbarbar
Chanfrein et ébarber



5B

Option 1: Copper Pipe

Opción 1: Tubo de Cobre
Option 1: Tuyau de Cuivre

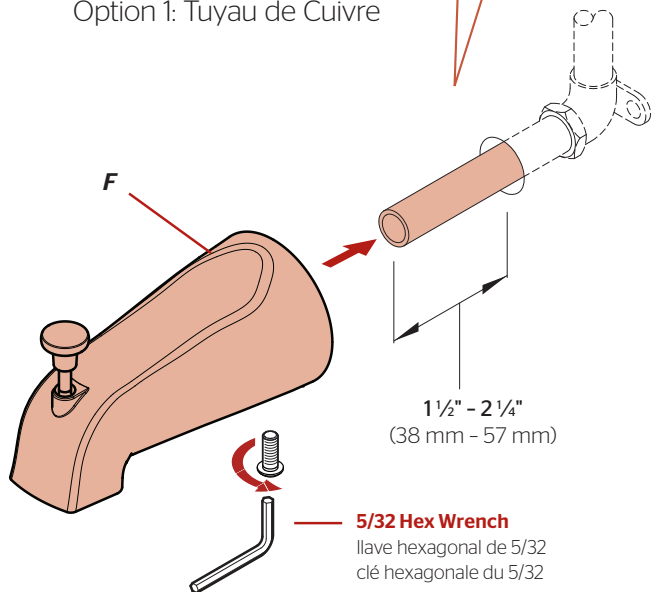

5/32 Hex Wrench
llave hexagonal de 5/32
clé hexagonale du 5/32

5B

Option 2: Threaded Pipe

Opción 2: Tubo Roscado
Option 2: Tuyau Fileté

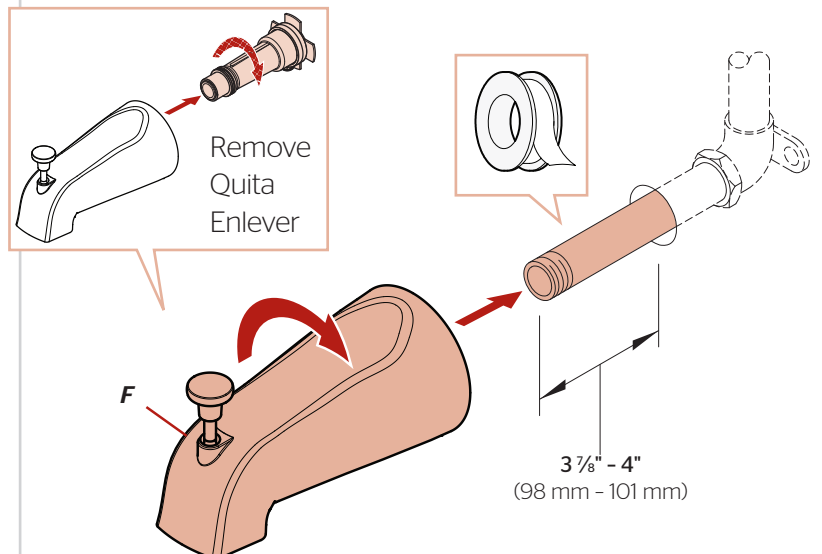

Remove
Quita
Enlever

6 Turn On Water & Flush

Active el suministro de agua y enjuague

Ouvrez l'eau et vidangez

No Tools Required for This Step
No se necesitan herramientas para este paso
Aucun outil n'est nécessaire pour cette étape



J

6A

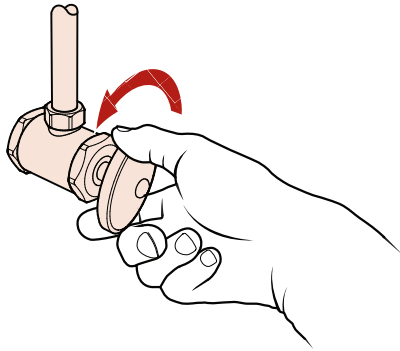

Turn on your water supply & check for any leaks.

Active el suministro de agua y revise si hay fugas.

Rétablissez l'alimentation en eau et vérifiez s'il y a des fuites.

Shower Functions • Funciones de la ducha • Fonctions de la douche

Pull up vertically to turn on shower.

Hale hacia arriba verticalmente para activar la ducha.

Tirez vers le haut verticalement pour mettre la douche en marché.

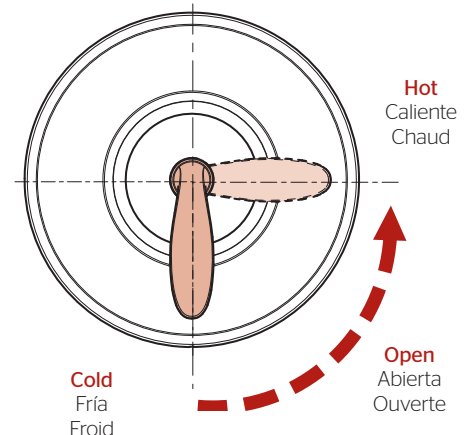
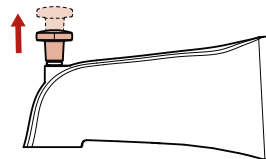

6B

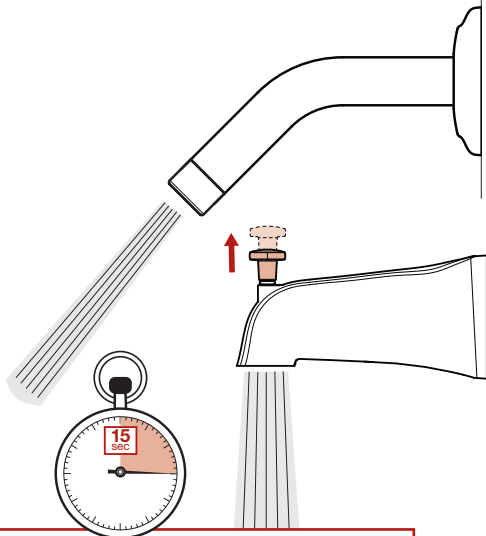

Allow full hot & full cold water to run for at least 15 seconds each.

Deje correr el agua caliente y fría durante al menos 15 segundos cada una.

Permettez à l'eau chaude et l'eau froide de couler au moins 15 secondes chacun.

6C

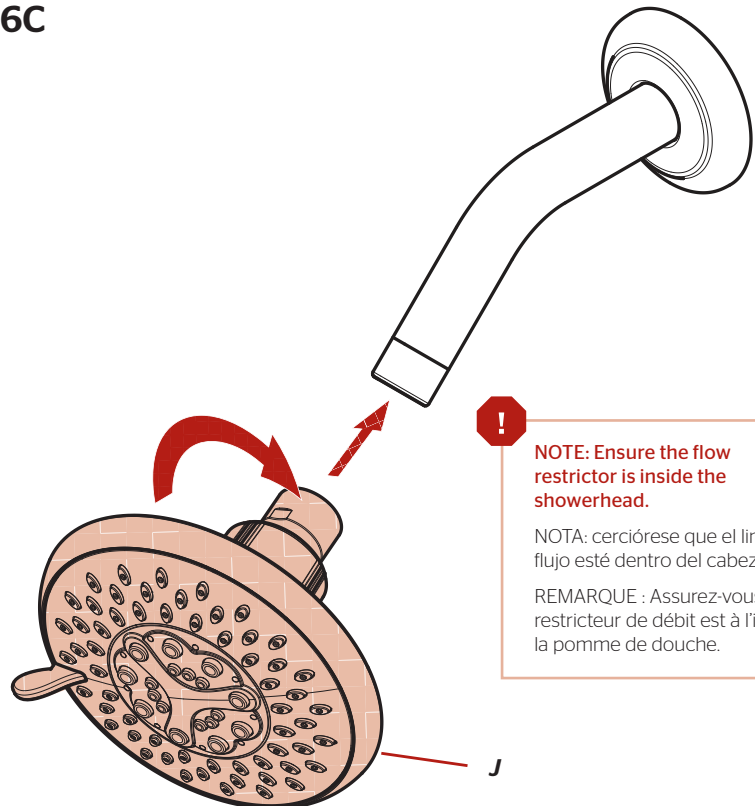

NOTE: Ensure the flow restrictor is inside the showerhead.

NOTA: cerciórese que el limitador de flujo esté dentro del cabezal de ducha.

REMARQUE : Assurez-vous que le restricteur de débit est à l'intérieur de la pomme de douche.

J



SAMPLE COPY

