

### Installation Support • Soporte de Instalación • Support d'Installation

#### Personal Assistance, Product Specs, & "How-to" Questions:

Asistencia personal, especificaciones del producto y preguntas sobre "cómo hacerlo":

Aide personnelle, spécifications du produit et questions « pratico-pratiques » :

## 1-800-PFAUCET (732-8238)

### pfisterfaucets.com/support

Installation Videos Available  
Videos de instalación a disposición  
Vidéos d'installation disponibles



pfisterfaucets.com/videos



### WARNING / ADVERTENCIA / AVERTISSEMENT

**To reduce the risk of injury or property damage, read all instructions before installing product. Wear safety goggles. Product must be installed in accordance with all state & local plumbing & building codes. Call a professional if you are uncertain about installing this product.**

Para disminuir el riesgo de lesiones o daños a la propiedad, lea todas las instrucciones antes de instalar el producto. Utilice gafas de seguridad. El producto deberá instalarse de acuerdo con la normativa de plomería y construcción estatal y local. Llame a un profesional si no está seguro sobre cómo instalar este producto.

Pour réduire le risque de blessures ou de dommages, lire toutes les instructions avant d'installer le produit. Portez des lunettes de sécurité. Il faut installer le produit en respectant tous les codes de construction et de plomberie locaux et d'état. Appelez un professionnel si vous n'êtes pas certain de la façon d'installer ce produit.

#### Required Tools

Herramientas necesarias  
Outils nécessaires

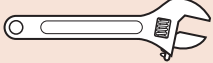

Adjustable Wrench  
Llave ajustable  
Clé réglable



Safety Goggles  
Gafas de seguridad  
Lunettes de sûreté

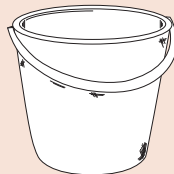

Bucket  
Balde  
Seau

#### Additional Helpful Tools

Otras herramientas útiles  
Outils supplémentaires utiles

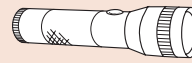

Flashlight  
Linterna  
Lampe De Poche



Cloth  
Paño  
Chiffon

#### Parts in the Box

Piezas en la caja  
Pièces dans la boîte

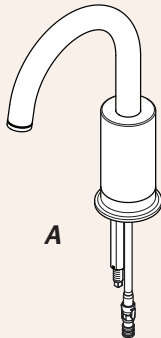

A

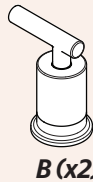

B (x2)



C (x2)

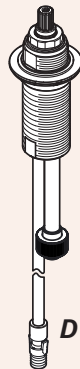

D (x2)



E (x2)



F



G



H

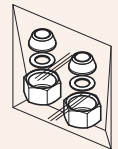

\*J

\*Supply nuts not required for installation  
No se requieren tuercas de suministro para la instalación  
Ecus d'alimentation non requis pour l'installation

## 1

### Turn Off Water Supply • Cierre el suministro de agua • Couper l'alimentation en eau



**Locate water supply inlets and shut off the water supply valves. These are usually found under the sink or near the water meter. If you are replacing an existing faucet, remove the old faucet from the sink and clean the sink surface thoroughly.**

Ubique las entradas del suministro de agua y cierre las válvulas de suministro de agua. Generalmente se encuentran debajo del fregadero o cerca del medidor de agua. Si se trata de un reemplazo de grifo, quite el grifo viejo y limpie completamente la superficie del fregadero.

Recherchez les entrées d'approvisionnement et fermer leurs robinets. Ces robinets se trouvent généralement sous l'évier ou près du compteur d'eau. Si vous remplacez un robinet existant, retirez, le vieux robinet et nettoyer soigneusement la surface de l'évier.

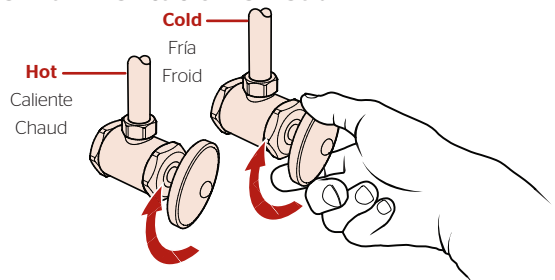

# 2

## Valve Installation Instalación de las válvulas Montage des valves

No Tools Required for This Step  
No se necesitan herramientas para este paso  
Pas d'outil nécessaire pour cette étape

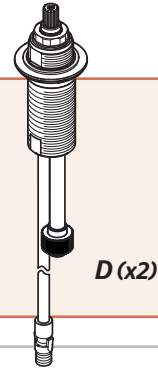

2A

**The HOT valve, with Red Ring should be positioned to the left side of the spout.**

La válvula del agua CALIENTE, con el anillo rojo, debe colocarse a la izquierda del surtidor.

La valve d'eau CHAUDE, avec l'anneau rouge, doit être placée sur le côté gauche du bec.

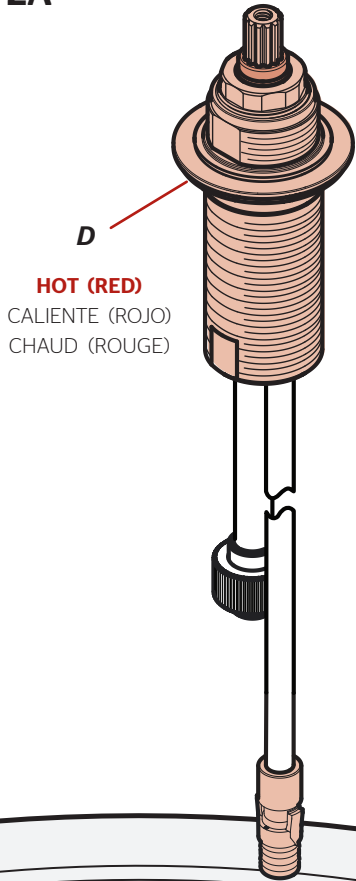

**HOT (RED)**  
CALIENTE (ROJO)  
CHAUD (ROUGE)

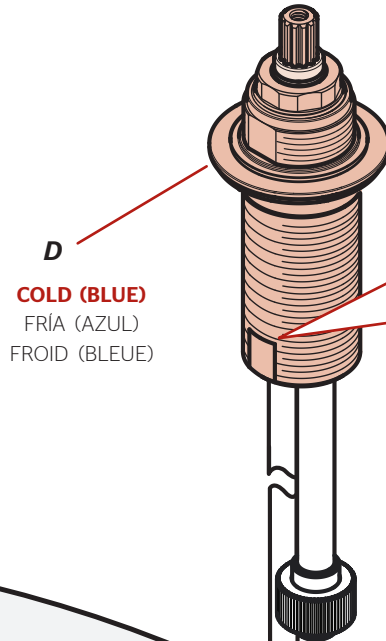

**COLD (BLUE)**  
FRÍA (AZUL)  
FROID (BLEUE)

**x2**  
**Location of flats may vary.**

Localización de el plano puede ser diferente.  
Localisation de la fente peut être différent

2B

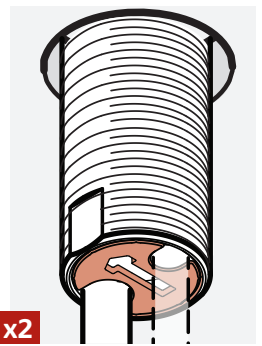

**Position valve arrow to face sink, this ensures handle will be aligned.**

Posicione la flecha para enfrentar el fregadero, esto asegura manivela estará alineada.

Positionnez la flèche pour faire face à l'évier ce qui assure poignée est aligné.

### 3 Secure Valve Bodies & Install Handles

#### Asegurar el cuerpo de la válvula y instale las manijas

#### Fixez les corps de valve et Installez les poignées

No Tools Required for This Step  
 No se necesitan herramientas para este paso  
 Pas d'outil nécessaire pour cette étape

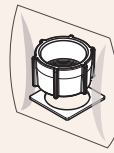

E (x2)



B (x2)



C (x2)

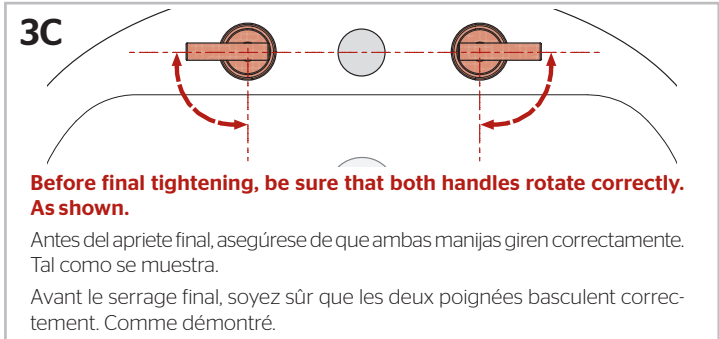
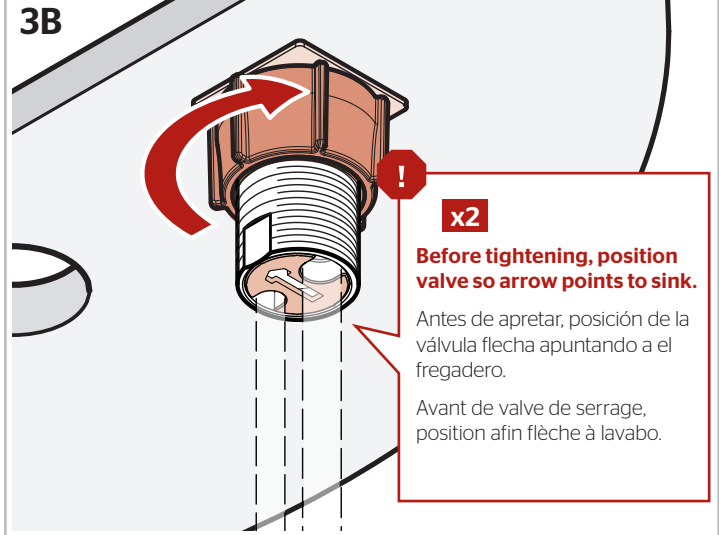
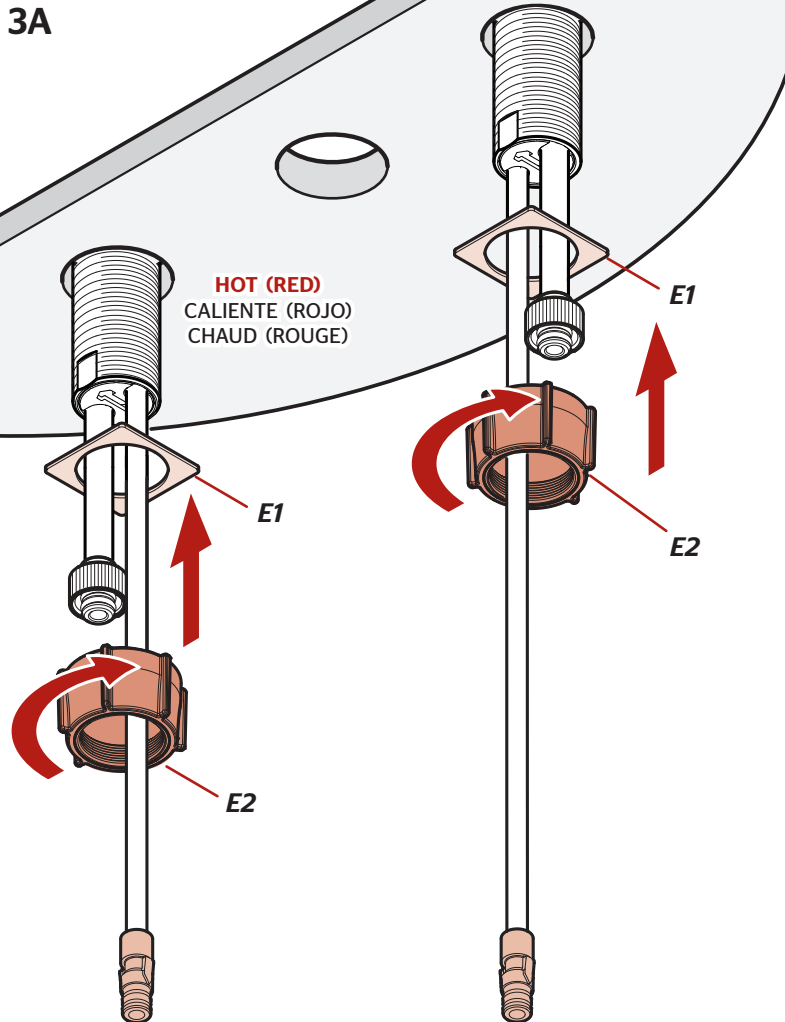

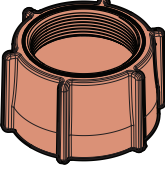

**Use nut with threads up for decks up to 2" thick.**  
 Utilice la tuerca con rosca para cubiertas de hasta 51mm de espesor.  
 Utiliser l'écrou avec filetage pour les ponts jusqu'à 51mm d'épaisseur.

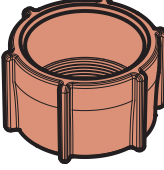

**Use nut with threads down for decks up to 1-1/2 thick.**  
 Utilice la tuerca con rosca hacia abajo para cubiertas de hasta 38mm de espesor.  
 Utiliser l'écrou avec des fils vers le bas pour les terrasses jusqu'à 38mm d'épaisseur.

**!**  
**If deck is thicker than 2", order Valve Extension Kit 900-058 / 900-059.**  
 Si la plataforma es más gruesa de 51mm, por favor pida la pieza de repuesto 900-058 / 900-059.  
 Si le pont est plus épais que 51mm, SVP commandez le kit d'extension 900-058 / 900-059.

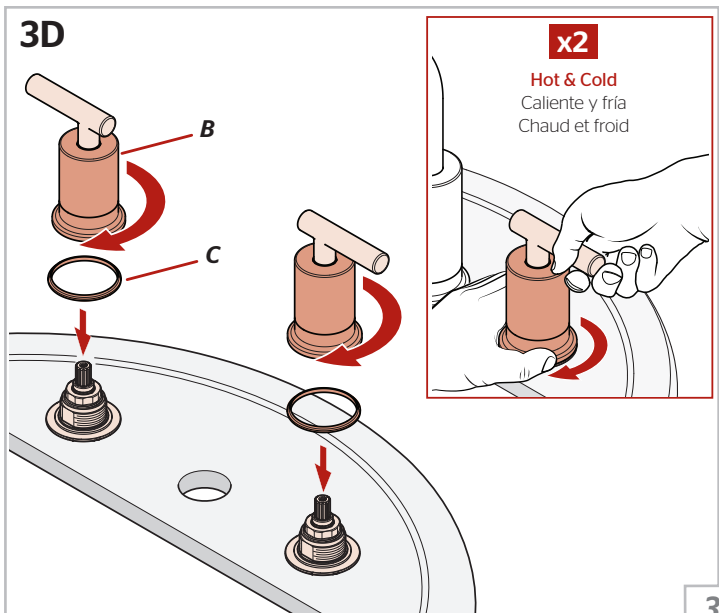

# 4 Install Spout

## Instale el surtidor

### Installez le bec

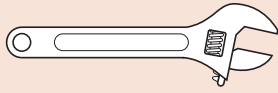

Adjustable Wrench  
Llave ajustable  
Clé réglable

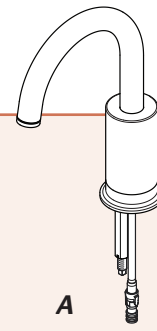

A

4A

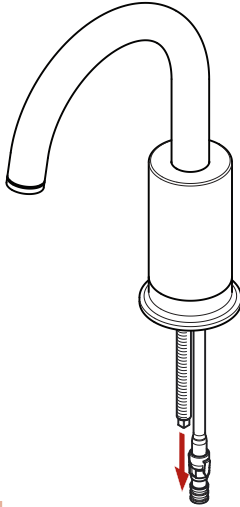

**Remove A1 and A2 before installing spout.**

Quite A1 y A2 antes de instalar el grifo.

Retirer A1 et A2 avant d'installer le robinet.

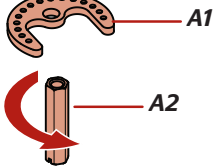

4B

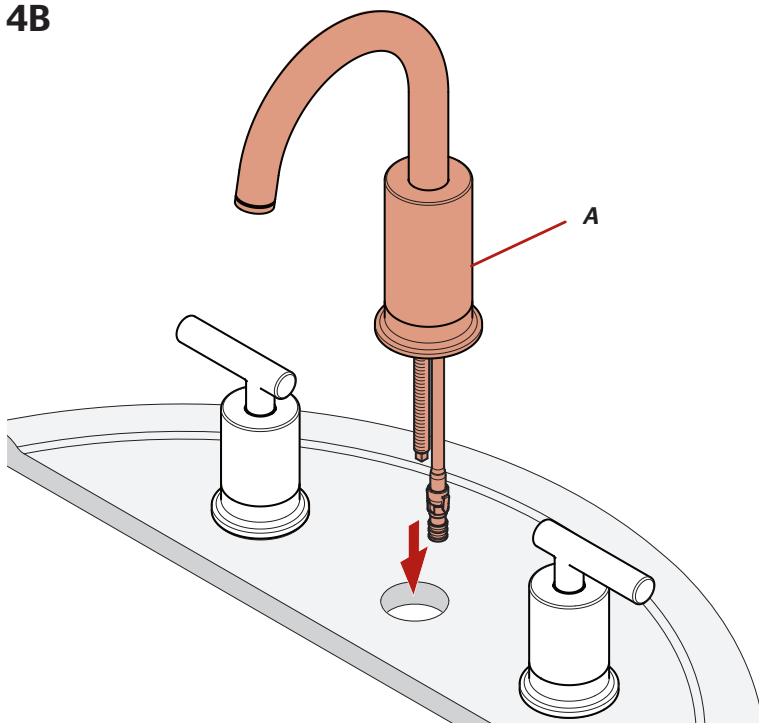

4C

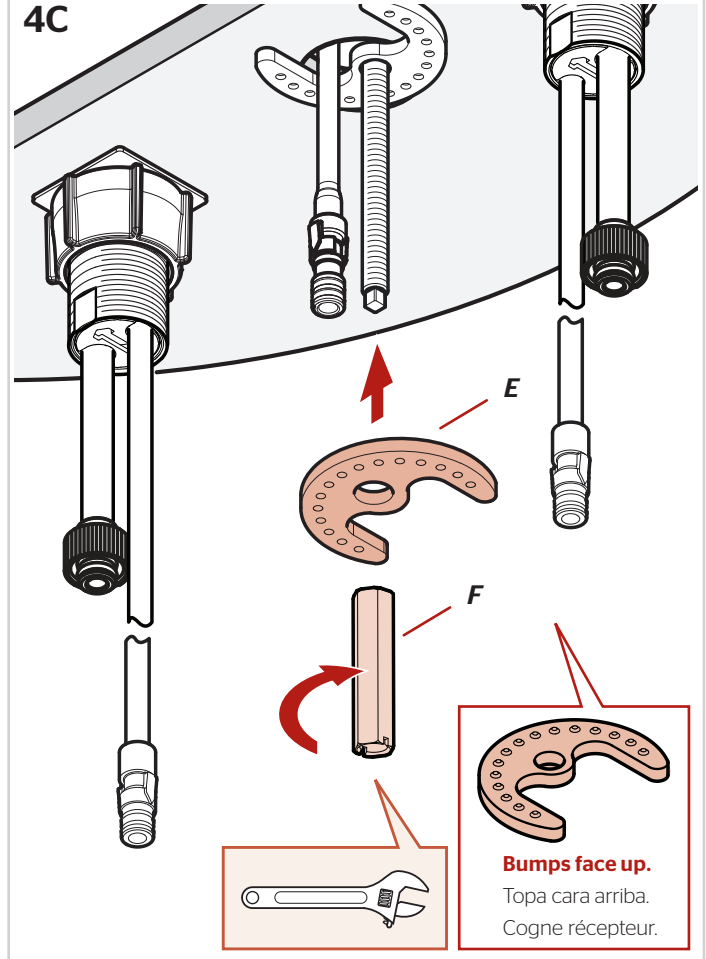

**Bumps face up.**  
Topa cara arriba.  
Cogne récepteur.

# 5

## Hose Connections

### Conecciones de la manguera

### Connexions des tuyaux

No Tools Required for This Step  
 No se necesitan herramientas para este paso  
 Pas d'outil nécessaire pour cette étape



G

5A

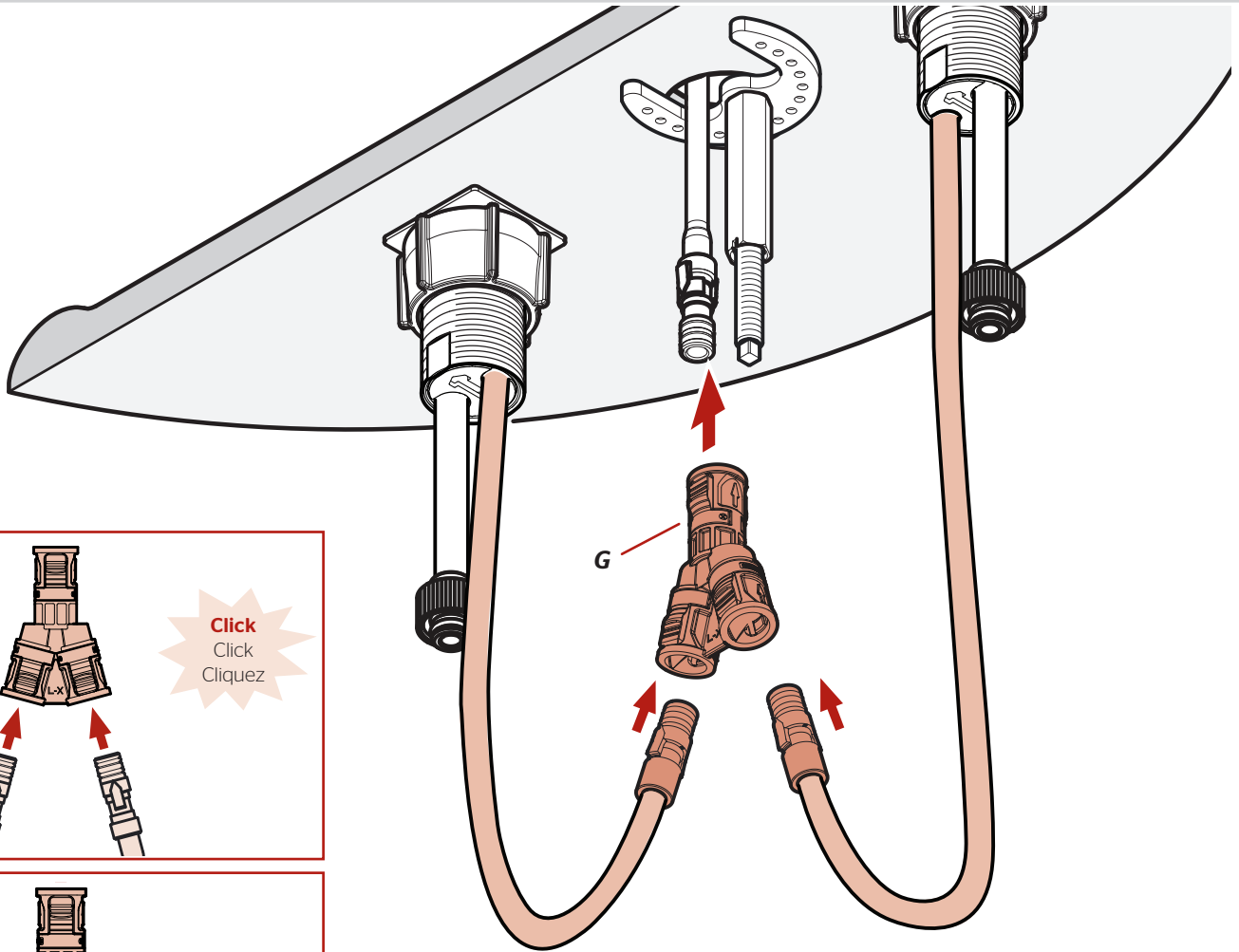

5B

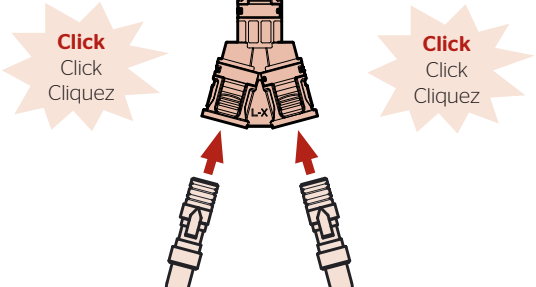

5C

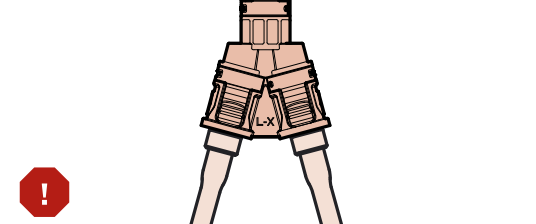

**Check that connections are secure by pulling down on the tubes while avoiding buttons. They should not come off the spout connector.**

Compruebe que las conexiones estén aseguradas tirando abajo de los tubos evitando botones. No deben salir de la conexión del surtidor.

Vérifiez que les connexions sont sécurisées en tirant vers le bas les tubes en évitant les leviers. Ils ne doivent pas laisser la connexion bec.

5D

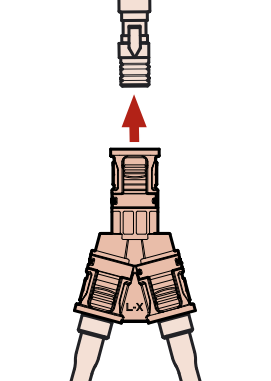

5E

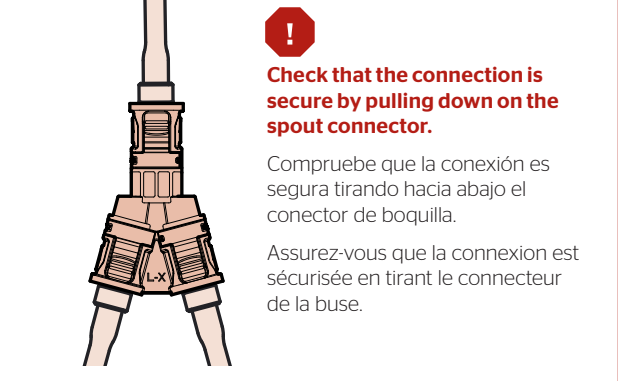

**Check that the connection is secure by pulling down on the spout connector.**

Compruebe que la conexión es segura tirando hacia abajo el conector de boquilla.

Assurez-vous que la connexion est sécurisée en tirant le connecteur de la buse.

## 6 Connect Water Supply Lines Conecte las tuberías de suministro de agua Raccorder les conduites d'alimentation en eau

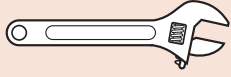

Adjustable Wrench  
Llave ajustable  
Clé à Mollette

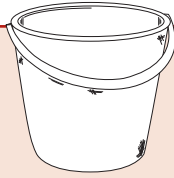

Bucket  
Balde  
Seau



D



F(x2)

**!** Water Supply Lines not included. Please consult manufacturer and/or its instructions for the correct method of installation of supply lines & fittings. **IMPORTANT: Incorrect application of supply lines and fittings may result in the failure or leak of the supply lines and fitting.**

Las tuberías de suministro de agua no están incluidas. Consulte por favor el fabricante y/o sus instrucciones para el método correcto de instalación de líneas de suministro y de guarniciones.

**IMPORTANT:** El uso incorrecto de líneas de suministro y de guarniciones puede dar lugar a la falta o al escape de las líneas de suministro y de la guarnición.

Les tuyaux d'arrivée d'eau ne sont pas fournis. Veuillez consulter le fabricant et/ou ses instructions pour la méthode correcte d'installation des conduites d'alimentation en eau et des accessoires.

**IMPORTANT:** Mauvaise application des lignes d'alimentation et accessoires peut entraîner la défaillance ou la fuite.

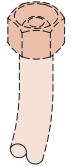

**HOT**  
CALIENTE  
CHAUD

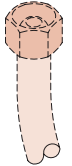

**COLD**  
FRÍA  
FROID

**6A** **Point Lines in Bucket**  
Guiar las Líneas hacia el Balde  
Guide les lignes en le Balde

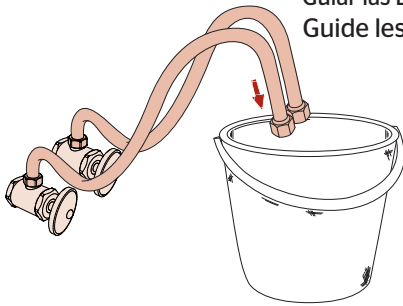

**6E** **x2**  
**Hot & Cold**  
Caliente y fría  
Chaud et froid

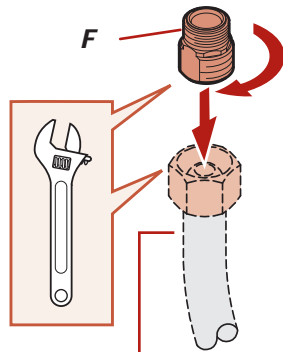

**Water supply line**  
línea de suministro del agua  
Ligne d'approvisionnement en eau

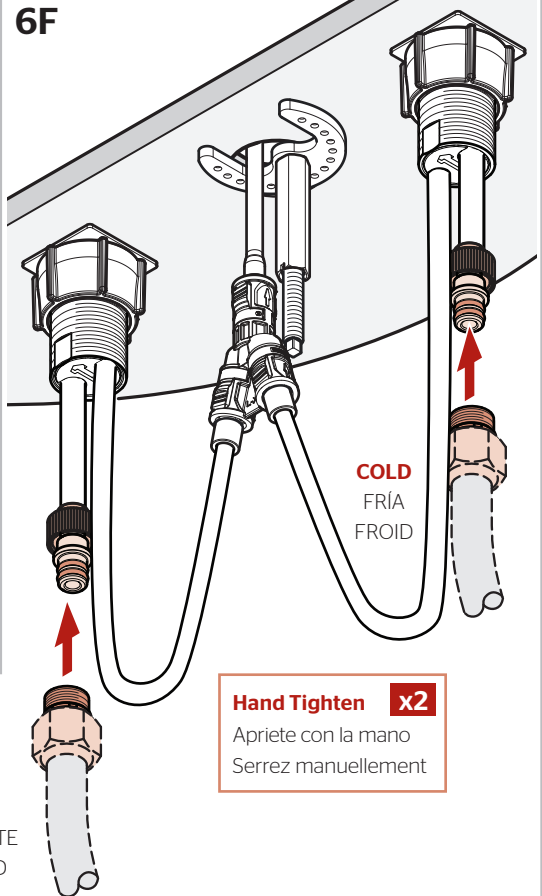

**Hand Tighten x2**  
Apriete con la mano  
Serrez manuellement

**HOT**  
CALIENTE  
CHAUD

**6B** **Turn On Water**  
Active el suministro de agua  
Ouvrez l'eau

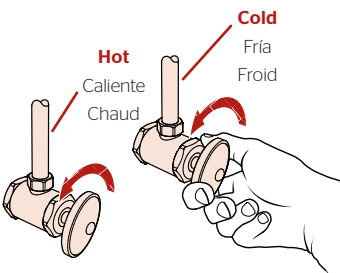

**6C** **Flush Lines**  
Enjuagar las Líneas  
Rincer les Lignes

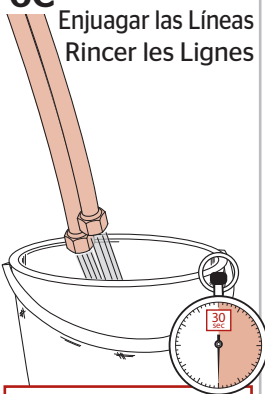

**Allow water to run for at least 30 seconds.**

Deje correr el agua durante al menos 30 segundos.

Permettez à l'eau couler au moins 30 secondes.

**6D** **Turn Off Water Supply**  
Cierre el suministro de agua  
Couper l'alimentation en eau

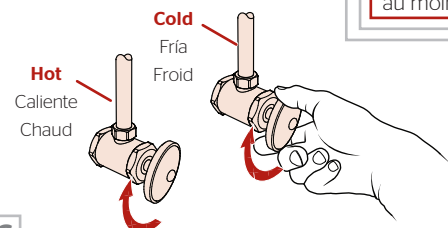

**x2**  
**Hot & Cold**  
Caliente y fría  
Chaud et froid

**Water supply line**  
línea de suministro del agua  
Ligne d'approvisionnement en eau

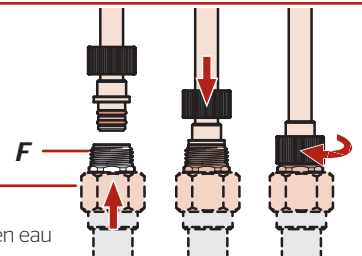

# 7 Prepare & Install Push & Seal™ Drain

## Prepare y instale cuerpo de drenaje Push & Seal™

### Préparez & installez le corps de drainage Push & Seal™

No Tools Required for This Step  
 No se necesitan herramientas para este paso  
 Pas d'outil nécessaire pour cette étape

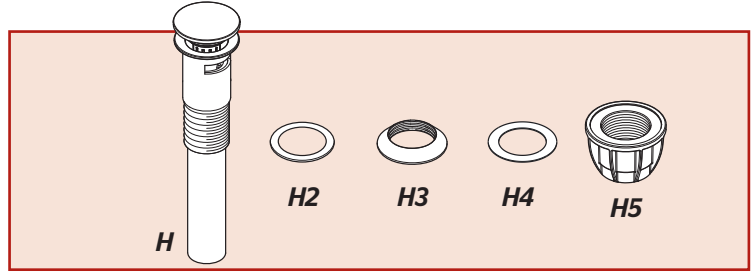

#### 7A Disassemble Pop-Up

##### Desensamble el cuerpo de drenaje

##### Démontez le corps de drainage

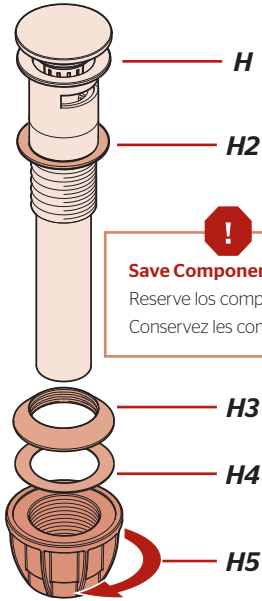

**Save Components.**  
 Reserve los componentes.  
 Conservez les composants.

**Note: H2 (rubber) & H4 (plastic)**  
 Nota: H2 (goma) & H4 (plástico)  
 Remarque: H2 (gomme) & H4 (plastique)

#### 7B

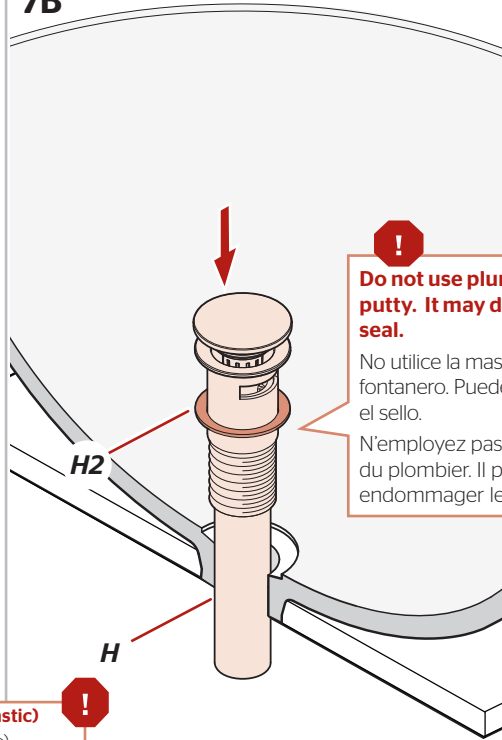

**Do not use plumber's putty. It may damage seal.**

No utilice la masilla del fontanero. Puede dañar el sello.  
 N'employez pas le mastic du plombier. Il peut endommager le joint.

#### 7C

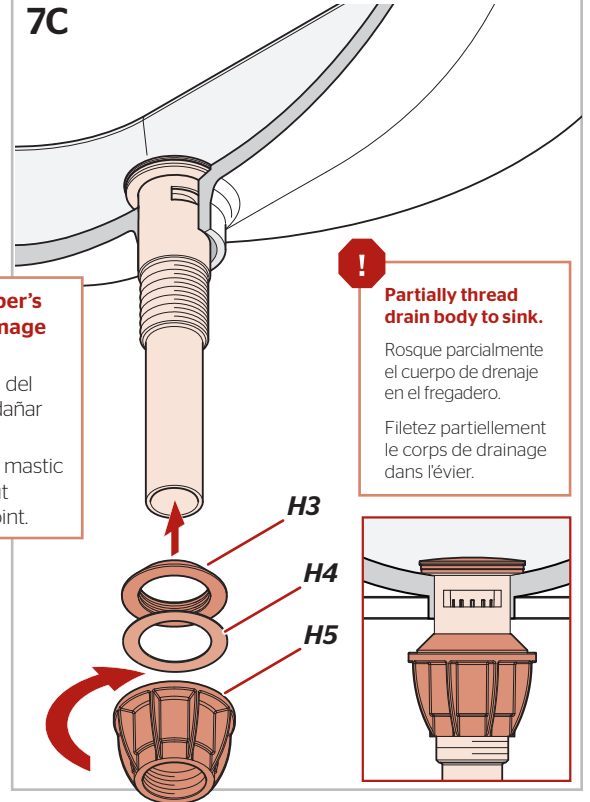

**Partially thread drain body to sink.**

Rosque parcialmente el cuerpo de drenaje en el fregadero.

Filetez partiellement le corps de drainage dans l'évier.

#### 7D

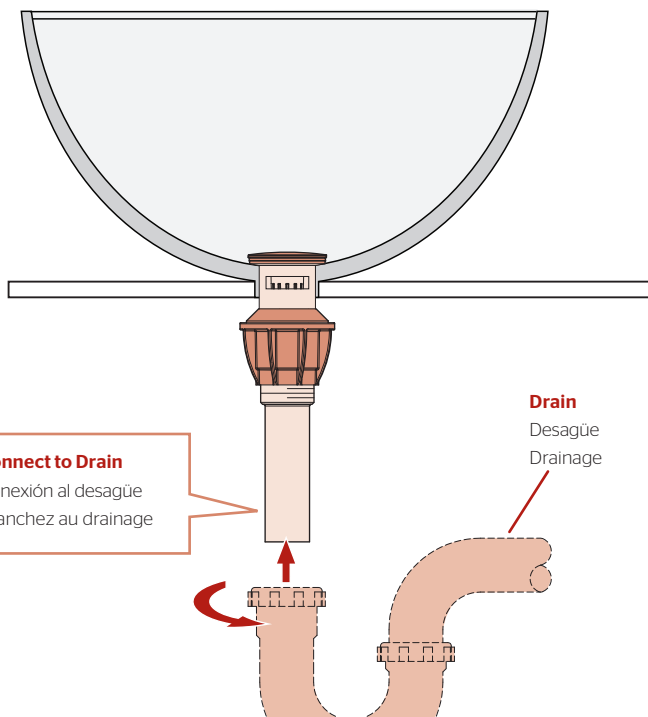

**Connect to Drain**  
 Conexión al desagüe  
 Branchez au drainage

**Drain**  
 Desagüe  
 Drainage

#### 7E

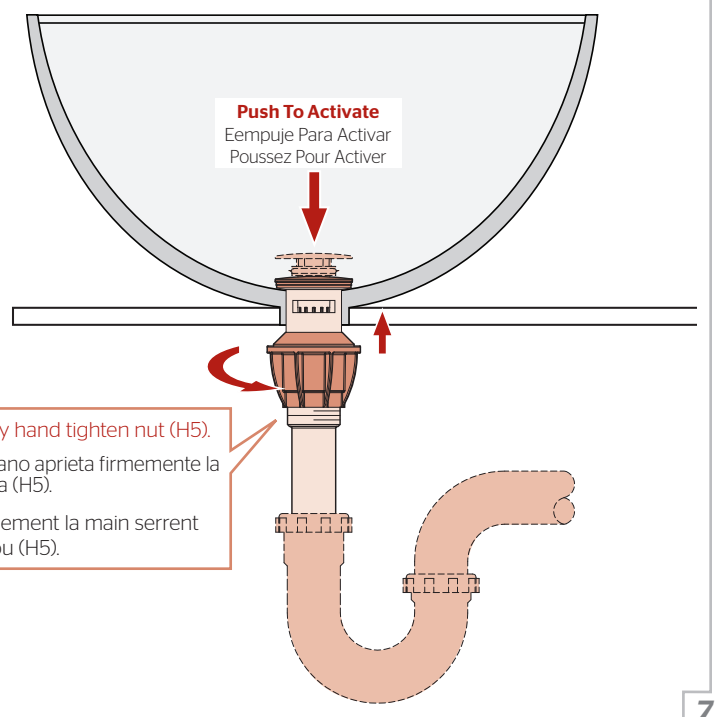

**Push To Activate**  
 Empuje Para Activar  
 Poussez Pour Activer

**Firmly hand tighten nut (H5).**  
 La mano aprieta firmemente la tuerca (H5).

Ferment la main serrent l'écrou (H5).

## 8 Turn On Water & Confirm Proper Installation

Active el suministro de agua y confirme que la instalación está adecuadamente efectuada

Ouvrez l'eau et confirmez que l'installation est adéquate

### 8A

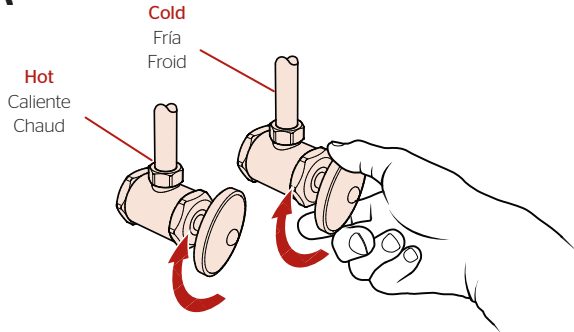

### Faucet Functions • Funciones del grifo • Fonctions du robinet

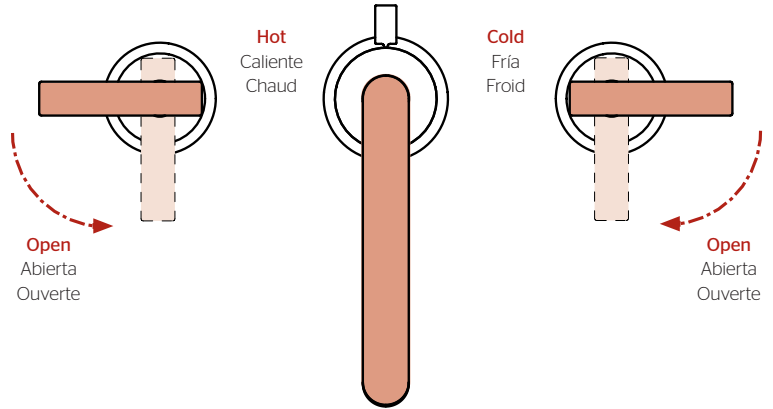

**Check for leaks above and below the sink.**

Revise si hay fugas encima y debajo del fregadero

Assurez-vous qu'il n'y a pas de fuite au dessus ou au dessous du lavabo

## 9 Flush the Faucet

Enjuague el grifo

Vidanger l'robinet

### 9A Remove Aerator

Retire el aereador  
Retirez l'aérateur

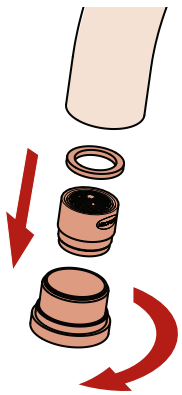

### 9B

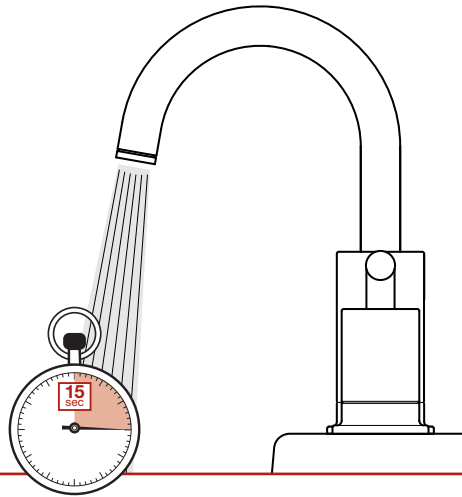

**Allow full hot & full cold water to run for at least 15 seconds each.**

Deje correr el agua caliente y fría durante al menos 15 segundos cada una.

Permettez à l'eau chaude et l'eau froide de couler au moins 15 secondes chacun.

### 9C Reinstall Aerator

Reinstale el aereador  
Réinstallez l'aérateur

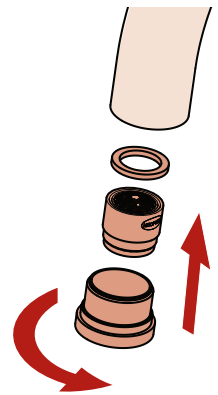

**Hand Tighten**

Apriete con la mano

Serrez manuellement

**For Additional Installation Help:**

Para la instalación adicionales de ayuda:

Pour les aides supplémentaires à l'installation:

**Pfister**

**1-800-PFAUCET (732-8238)**  
**pfisterfaucets.com**