

Installation Support • Soporte de instalación • Support d'installation

Personal Assistance, Product Specs, & "How-to" Questions:

Asistencia personal, especificaciones del producto y preguntas sobre "cómo hacerlo":

Aide personnelle, spécifications du produit et questions « pratico-pratiques » :

1-800-PFAUCET (732-8238)
pfisterfaucets.com/support

Installation Videos Available
Videos de instalación a disposición
Vidéos d'installation disponibles



pfisterfaucets.com/videos

▲ WARNING / AVERTENCIA / AVERTISSEMENT

To reduce the risk of injury or property damage, read all instructions before installing product. Wear safety goggles. Product must be installed in accordance with all state & local plumbing & building codes. Call a professional if you are uncertain about installing this product.

Para disminuir el riesgo de lesiones o daños a la propiedad, lea todas las instrucciones antes de instalar el producto. Utilice gafas de seguridad. El producto deberá instalarse de acuerdo con la normativa de plomería y construcción estatal y local. Llame a un profesional si no está seguro sobre cómo instalar este producto.

Pour réduire le risque de blessures ou de dommages, lire toutes les instructions avant d'installer l'appareil. Porter des lunettes de sécurité. Il faut installer l'appareil en respectant tous les codes de construction et de plomberie locaux et d'État. Appelez un professionnel si vous n'êtes pas certain de la façon d'installer cet appareil.

**Required Tools
Herramientas necesarias
Outils nécessaires**



Adjustable Wrench
Llave ajustable
Clé réglable

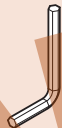

6mm Hex Wrench
6mm Llave hexagonal
6mm Clé hexagonale



Safety Goggles
Anteojos de seguridad
Lunettes de sûreté



PTFE plumber's tape
Cinta para plomería PTFE
Ruban PTFE de plombier

**Additional Helpful Tools
Otras herramientas útiles
Outils supplémentaires utiles**

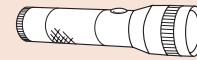

Flashlight
Linterna
Lampe-torche



Cloth
Paño de limpieza
Chiffon

**Parts in the Box
Piezas en la caja
Pièces dans la boîte**

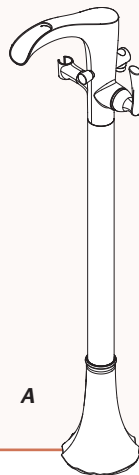

A



B



C

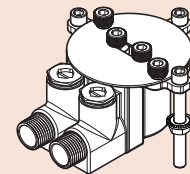

OX6-270R Valve sold separately
OX6-270R Válvula se vende por separado
OX6-270R Valve vendu séparément

1 Turn Off Water Supply • Cierre el suministro de agua • Couper l'alimentation en eau

Locate the water supply inlets & shut off the water supply valves. These are usually found near the water meter.

If you are replacing an existing unit, remove the old unit & clean mounting surface thoroughly.

Ubique las entradas del suministro de agua y cierre las válvulas de suministro. Estas se encuentran generalmente cerca del medidor de agua. Si reemplaza una unidad existente, retírela y limpie completamente la superficie de montaje.

Repérez les entrées d'alimentation d'eau et fermez les robinets d'arrêt. Ils sont normalement trouvés près du compteur d'eau. Si vous remplacez un appareil existant, enlevez le vieil appareil et nettoyez soigneusement la surface de montage.

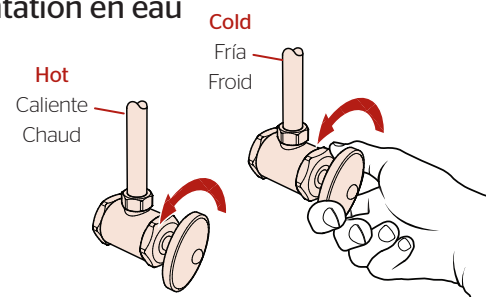

2 Spout Orientation

Prepare la tubería empotrada y configure la rotación del vástago

Préparez la plomberie brute et réglez la rotation

Pick where Faucet will be installed

Recogida en donde se instalará el grifo

Choisissez où le robinet sera installé

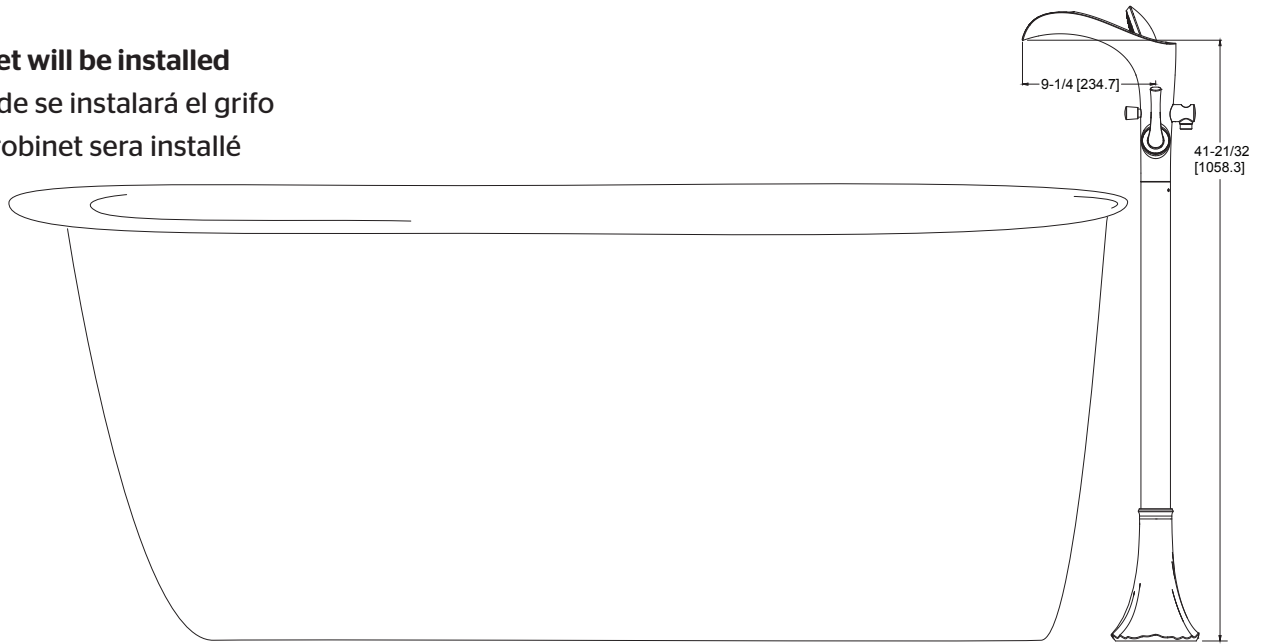

3 Prepare the Valve

Instale la Válvula

Installez la Soupape

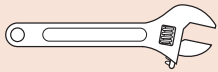

Adjustable Wrench
Llave ajustable
Clé réglable



PTFE plumber's tape
Cinta para plomería PTFE
Ruban PTFE de plombier



6mm Hex Wrench
6mm Llave hexagonal
6mm Clé hexagonale

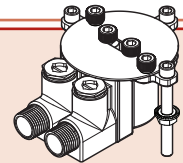

OX6-27OR Valve sold separately
OX6-27OR Válvula se vende por separado
OX6-27OR Valve vendu séparément

3A



trash basura poubelle

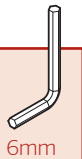

6mm

Wrap plumber's tape on male threads BEFORE installing.

Envuelva la cinta de plomero en en las roscas macho ANTES de instalar.
Enveloppez le ruban de plombier sur les filets mâles AVANT d'installer.

1/2-14 NPT

3B

4

Install Body

Instale el Cuerpo

Installez le corps

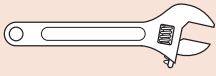

Adjustable Wrench
Llave ajustable
Clé réglable



6mm Hex Wrench
6mm Llave hexagonal
6mm Clé hexagonale

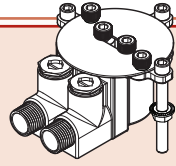

OX6-270R Valve sold separately
OX6-270R Válvula se vende por separado
OX6-270R Valve vendu séparément

4A

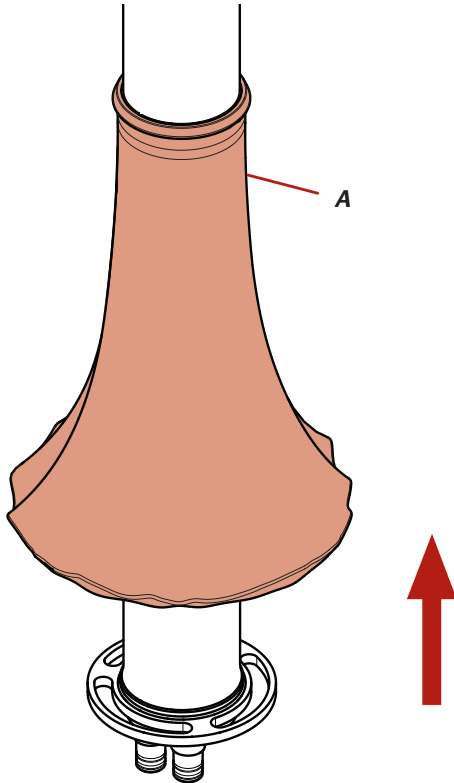

4C

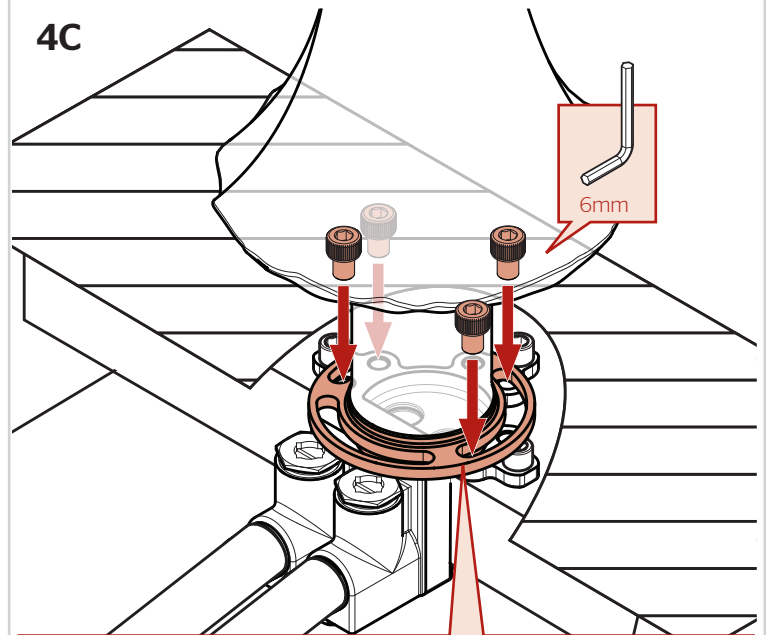

Insert Screws to 1 of 2 spots on the 3 prongs depending how flange (A) aligned.
Inserte los tornillos a 1 de 2 puntos en las 3 puntas dependiendo de cómo brida (A) alineo.
Insérer les vis 1 février points 3 points en fonction de la brida (A) alignés.

4B

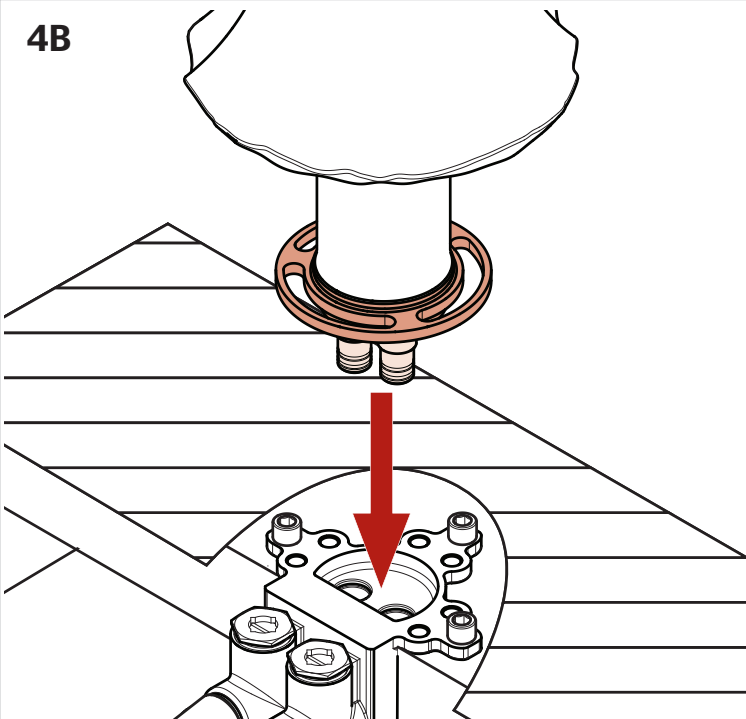

4D

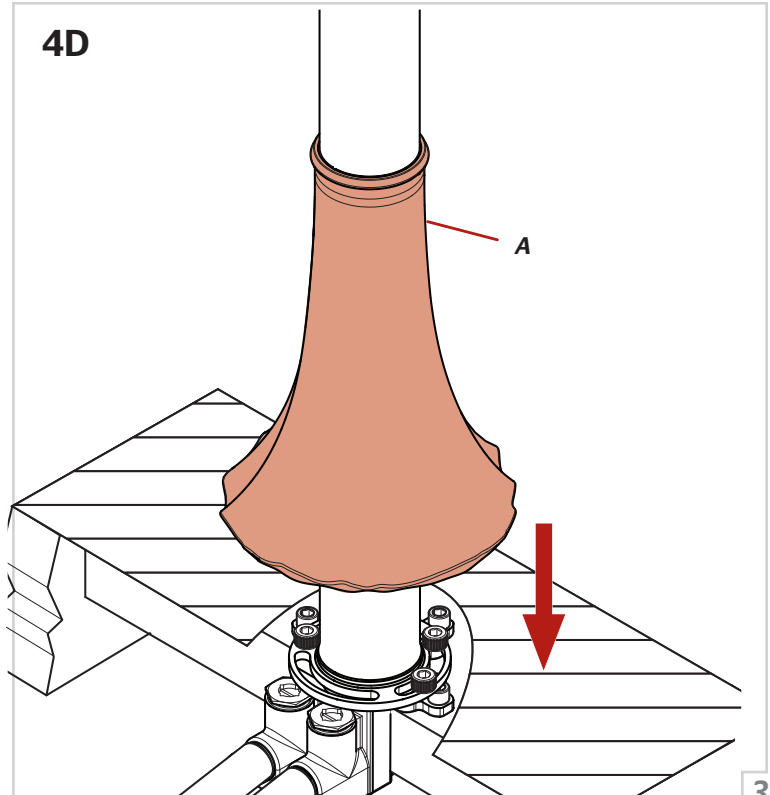

5

Install Hand shower

Instale la ducha de mano

Installez la douchette

No Tools Required for This Step
No se necesitan herramientas para este paso
Aucun outil n'est nécessaire pour cette étape



B



C

5A

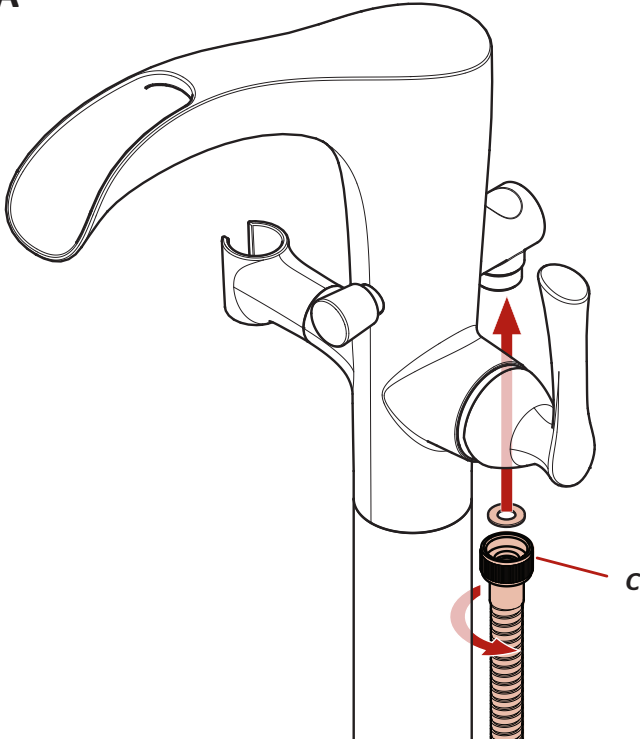

5C

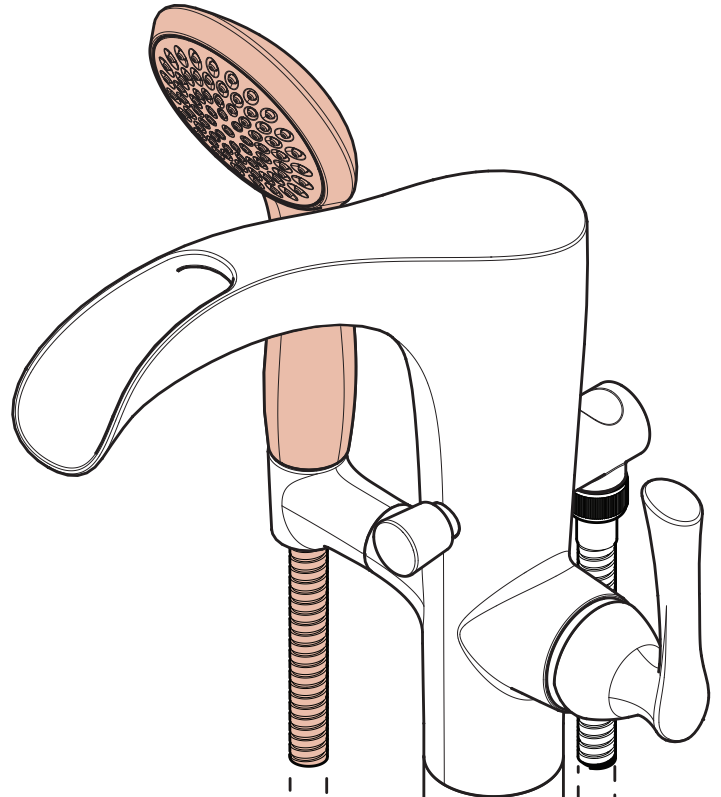

5B

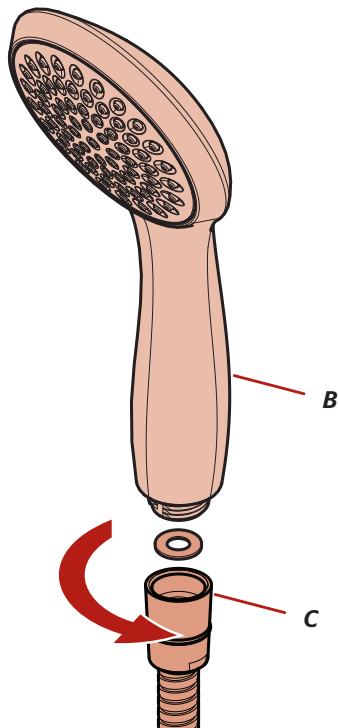

6 Turn On Water & Confirm Proper Installation

Active el suministro de agua y confirme que la instalación está adecuadamente efectuada
Ouvrez l'eau et confirmez que l'installation est adéquate

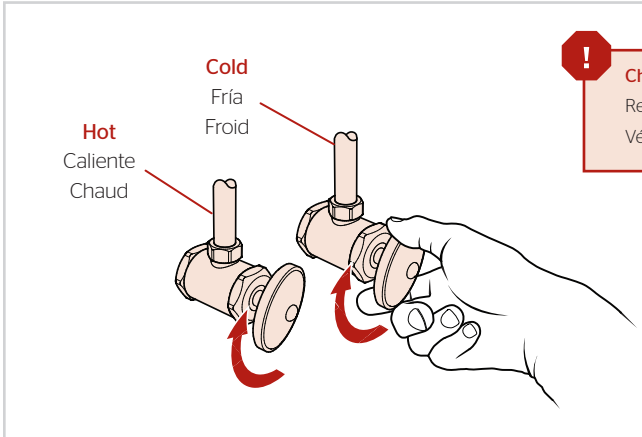

! **Check for leaks at water supply source.**
Revise si hay fugas en la fuente de suministro de agua.
Vérifier les fuites dans la source d'approvisionnement en eau.

7 Flush the Faucet

Enjuague el grifo
Vidanger l'robinet

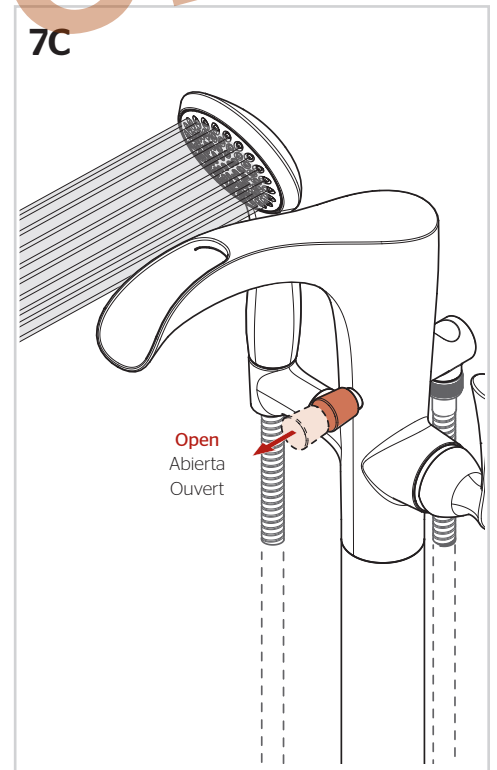
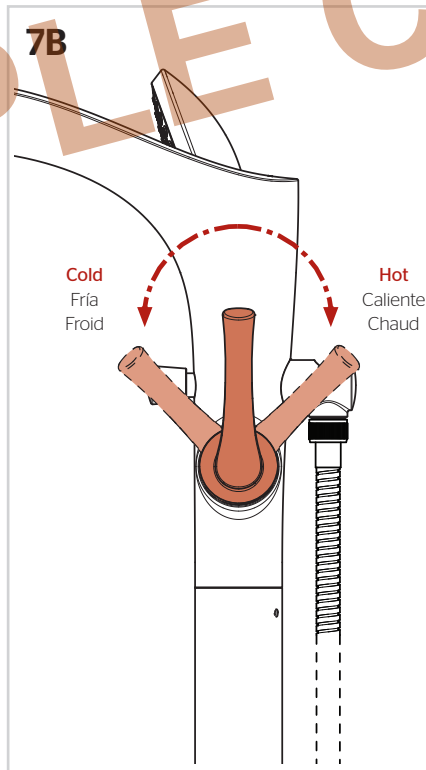
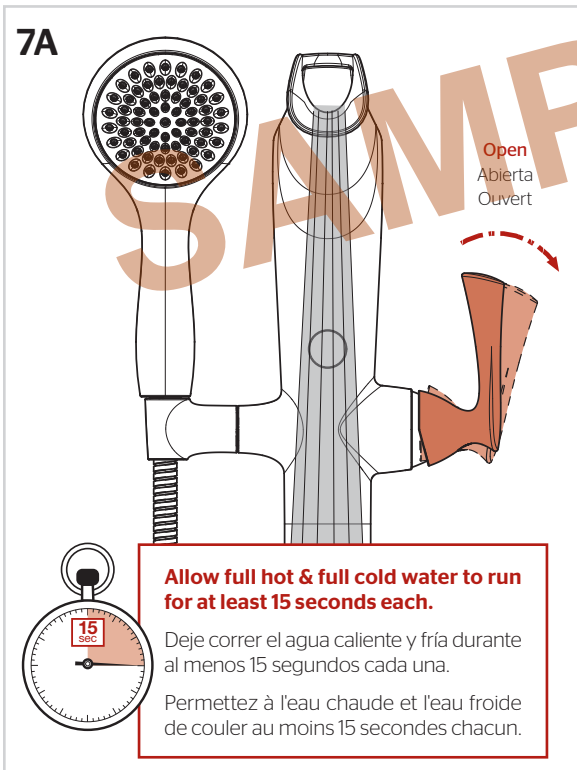

For Additional Installation Help:
Para la instalación adicionales de ayuda:
Pour aider à l'installation supplémentaires:

Pfister®

1-800-PFAUCET (732-8238)
pfisterfaucets.com