

#### Installation Support • Soporte de Instalación • Support d'Installation

#### Personal Assistance, Product Specs, & "How-to" Questions:

Asistencia personal, especificaciones del producto y preguntas sobre "cómo hacerlo":

Aide personnelle, spécifications du produit et questions « pratique-pratiques » :

**1-800-PFAUCET (732-8238)**

**pfisterfaucets.com/support**

Installation Videos Available  
Videos de instalación a disposición  
Vidéos d'installation disponibles



pfisterfaucets.com/videos



#### WARNING / ADVERTENCIA / AVERTISSEMENT

To reduce the risk of injury or property damage, read all instructions before installing product. Wear safety goggles. Product must be installed in accordance with all state & local plumbing & building codes. This product may take two people to install. Call a professional if you are uncertain about installing this product.

Para disminuir el riesgo de lesiones o daños a la propiedad, lea todas las instrucciones antes de instalar el producto. Utilice gafas de seguridad. El producto deberá instalarse de acuerdo con la normativa de plomería y construcción estatal y local. Este producto se puede tomar a dos personas para instalar. Llame a un profesional si no está seguro sobre cómo instalar este producto.

Pour réduire le risque de blessures ou de dommages, lire toutes les instructions avant d'installer le produit. Porter des lunettes de sécurité. Le produit doit être installé en conformité avec tous les codes de construction et de plomberie locaux et de l'état. Ce produit peut prendre deux personnes pour installer. Appelez un professionnel si vous n'êtes pas certain de la façon d'installer ce produit.

#### Required Tools

Herramientas necesarias  
Outils nécessaires



Adjustable Wrench  
Llave ajustable  
Clé réglable



Safety Goggles  
Gafas de seguridad  
Lunettes de sûreté

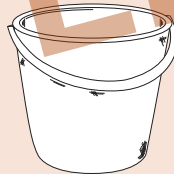

Bucket  
Balde  
Seau

#### Additional Helpful Tools

Otras herramientas útiles  
Outils supplémentaires utiles

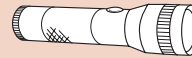

Flashlight  
Linterna  
Lampe De Poche



Cloth  
Paño  
Chiffon

#### Parts in the Box

Piezas en la caja  
Pièces dans la boîte

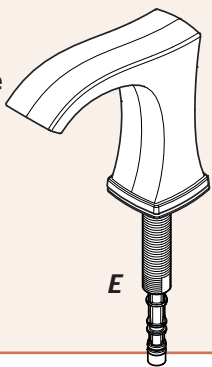
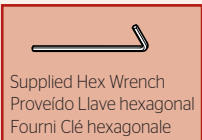

Top Tray  
Bandeja superior  
Plateau supérieur

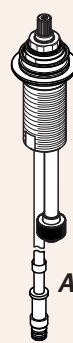
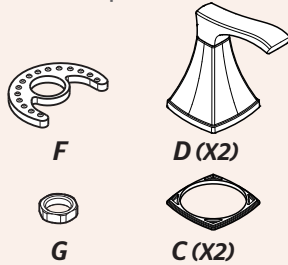

Lower Tray  
Bandeja inferior  
Plateau inférieur

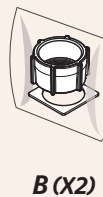

H

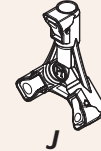

J

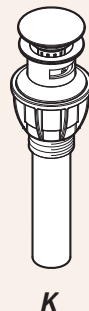

K

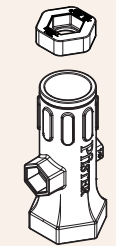

Supplied Install Tool  
Instalar la herramienta  
Outil d'installation fourni

## 1 Turn Off Water Supply • Cierre el suministro de agua • Couper l'alimentation en eau



Locate water supply inlets and shut off the water supply valves. These are usually found under the sink or near the water meter. If you are replacing an existing faucet, remove the old faucet from the sink and clean the sink surface thoroughly.

Ubique las entradas del suministro de agua y cierre las válvulas de suministro de agua. Generalmente se encuentran debajo del fregadero o cerca del medidor de agua. Si se trata de un reemplazo de grifo, quite el grifo viejo y limpie completamente la superficie del fregadero.

Recherchez les entrées d'approvisionnement et fermer leurs robinets. Ces robinets se trouvent généralement sous l'évier ou près du compteur d'eau. Si vous remplacez un robinet existant, retirez, le vieux robinet et nettoyer soigneusement la surface de l'évier.

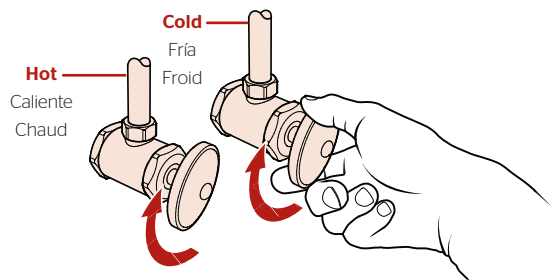

# 2

## Valve Installation Instalación de las válvulas Montage des valves

No Tools Required for This Step  
No se necesitan herramientas para este paso  
Pas d'outil nécessaire pour cette étape

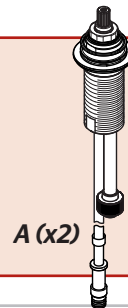

### 2A

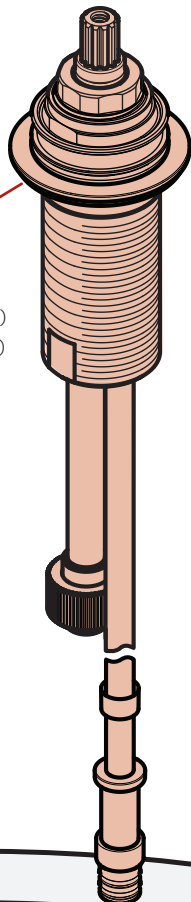

**HOT (RED)**  
CALIENTE (ROJO)  
CHAUD (ROUGE)

**The HOT valve, with Red Ring should be positioned to the left side of the spout.**

La válvula del agua CALIENTE, con el anillo rojo, debe colocarse a la izquierda del surtidor.

La valve d'eau CHAUDE, avec l'anneau rouge, doit être placée sur le côté gauche du bec.

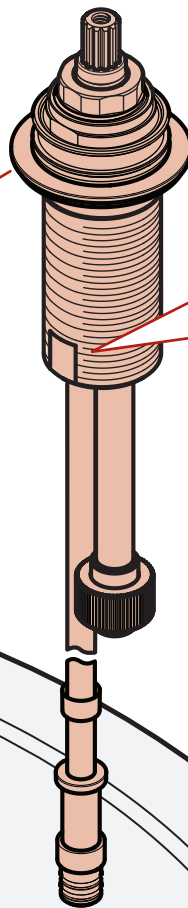

**COLD (BLUE)**  
FRÍA (AZUL)  
FROID (BLEUE)

**x2**  
**Location of flats may vary.**

Localización de el plano puede ser diferente.  
Localisation de la fente peut être différent

### 2B

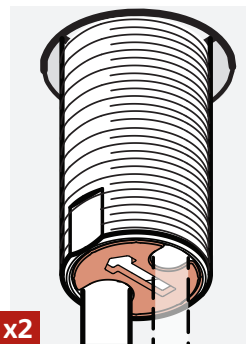

**Position valve arrow to point to sink, this ensures handle will be aligned.**

Posicione las flechas apuntando a fregadero, esto asegura manivela estará alineada.

Positionnez la flèche pointant vers à lavabo ce qui assure poignée est aligné.

### 3 Secure Valve Bodies & Install Handles

#### Asegurar el cuerpo de la válvula y instale las manijas

#### Fixez les corps de valve et Installez les poignées

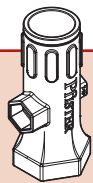

Supplied Install Tool  
Instalar la herramienta  
Outil d'installation fourni



Supplied Hex Wrench  
Proveído Llave hexagonal  
Fourni Clé hexagonale

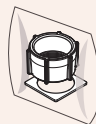

B (X2)



C (X2)



D (X2)

3A

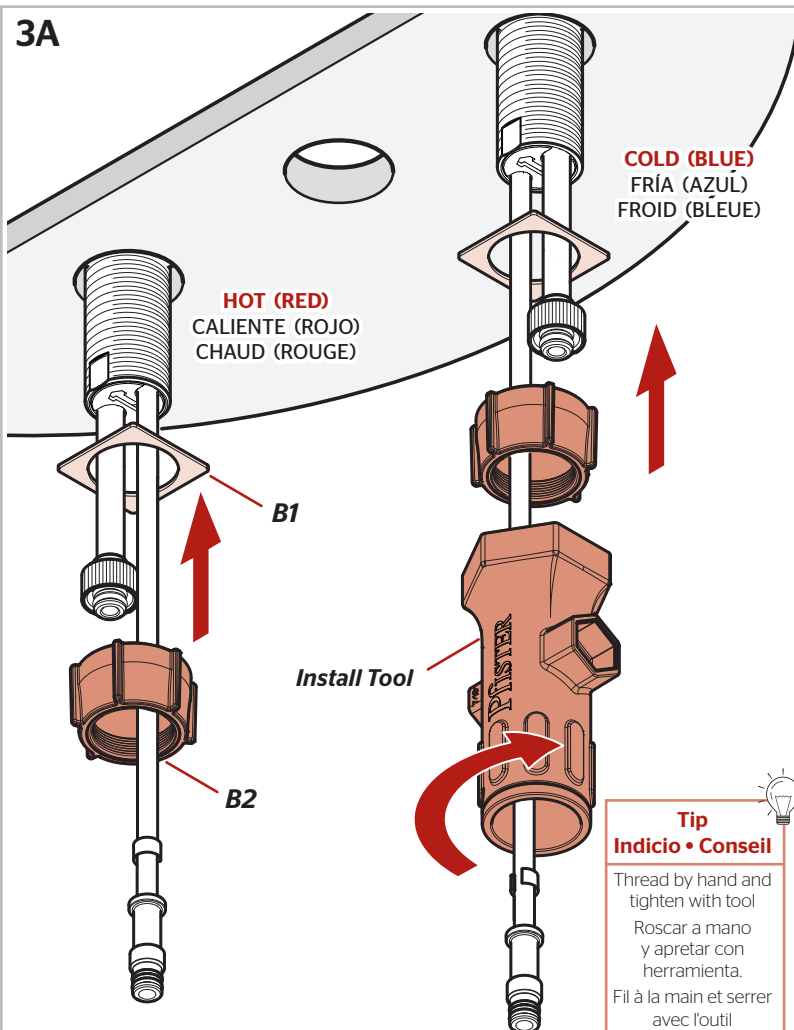

#### Tip Indicio • Conseil

Thread by hand and tighten with tool  
Roscar a mano y apretar con herramienta.  
Fil à la main et serrer avec l'outil

3B

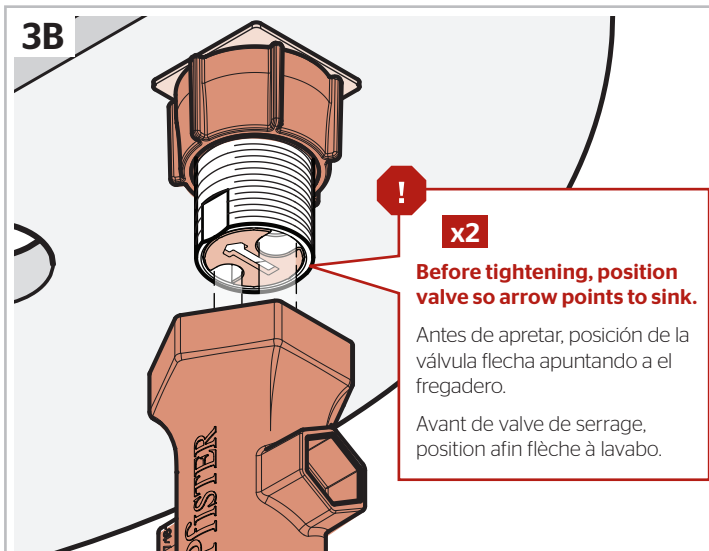

3C

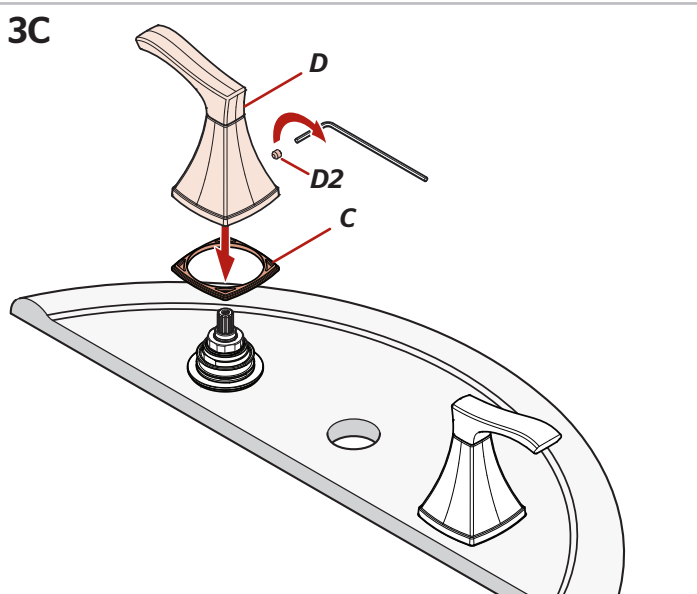

#### Before final tightening, be sure that both handles rotate correctly, as shown.

Antes del apriete final, asegúrese de que ambas manijas giren correctamente, tal como se muestra.

Avant le serrage final, soyez sûr que les deux poignées basculent correctement, comme démontré.

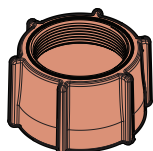

#### Use nut with threads up for decks up to 2" thick.

Utilice la tuerca con rosca para cubiertas de hasta 51mm de espesor.

Utiliser l'écrou avec filetage pour les ponts jusqu'à 51mm d'épaisseur.

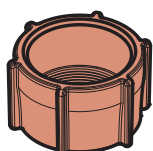

#### Use nut with threads down for decks up to 1-1/2" thick.

Utilice la tuerca con rosca hacia abajo para cubiertas de hasta 38mm de espesor.

Utiliser l'écrou avec des fils vers le bas pour les terrasses jusqu'à 38mm d'épaisseur.

#### ! If deck is thicker than 2", order Valve Extension Kit 900-0989.

Si la plataforma es más gruesa de 51mm, pida la pieza de repuesto 900-0989.

Si le pont est plus épais que 51mm, commandez le kit d'extension 900-0989.

**4** Install Spout  
 Instale el surtidor  
 Installez le bec

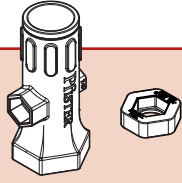

Supplied Install Tool  
 Instalar la herramienta  
 Outil d'installation fourni

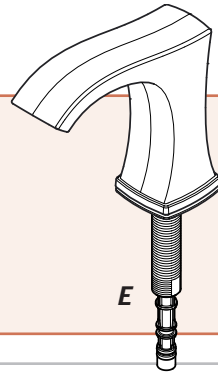

E

F

G

4A

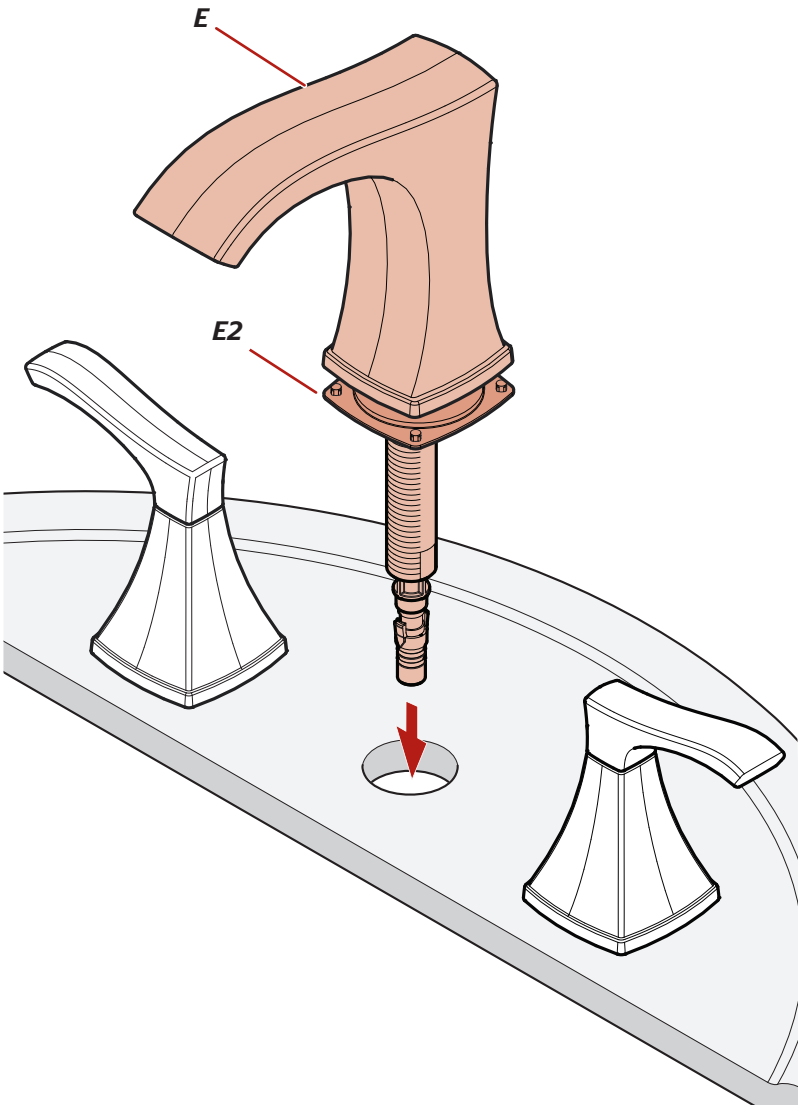

4B

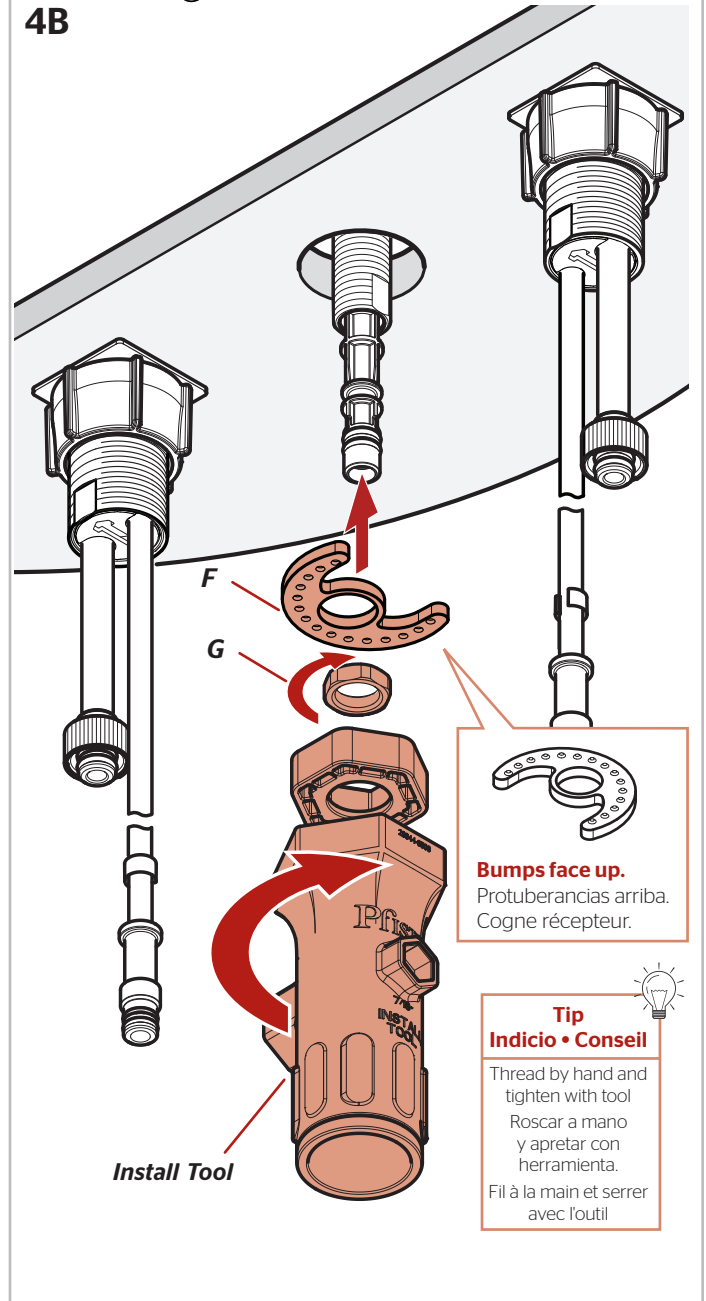

**Bumps face up.**  
 Protuberancias arriba.  
 Cogne récepteur.

**Tip**  
**Indicio • Conseil**

Thread by hand and  
 tighten with tool  
 Roscar a mano  
 y apretar con  
 herramienta.  
 Fil à la main et serrer  
 avec l'outil

# 5

## Hose Connections

### Conecciones de la manguera

### Connexions des tuyaux

No Tools Required for This Step  
 No se necesitan herramientas para este paso  
 Pas d'outil nécessaire pour cette étape

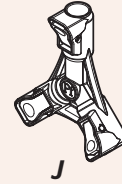

#### 5A

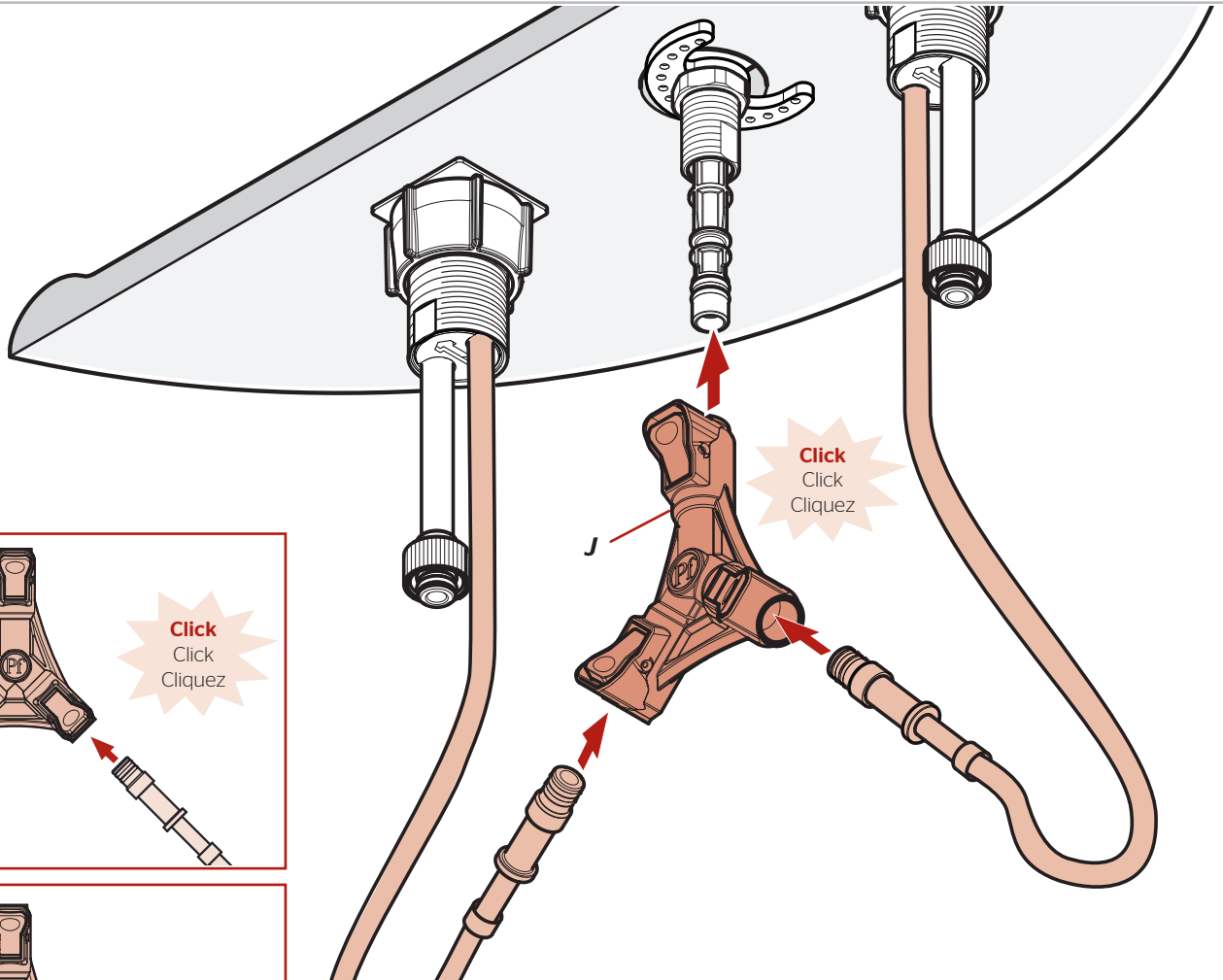

#### 5B

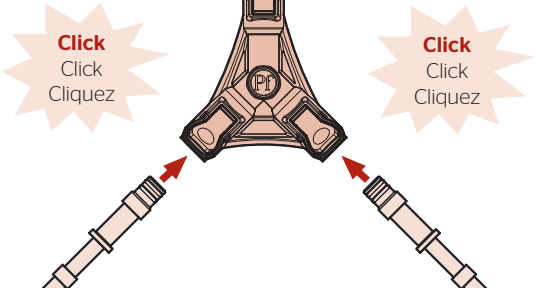

#### 5C

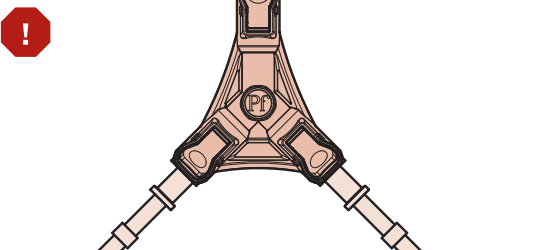

**Check that connections are secure by pulling down on the tubes while avoiding buttons. They should not come off the spout connector.**

Compruebe que las conexiones estén aseguradas tirando abajo de los tubos evitando botones. No deben salir de la conexión del surtidor.

Vérifiez que les connexions sont sécurisées en tirant vers le bas les tubes en évitant les leviers. Ils ne doivent pas laisser la connexion bec.

#### 5D

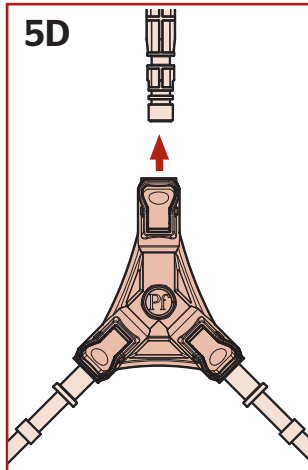

#### 5E

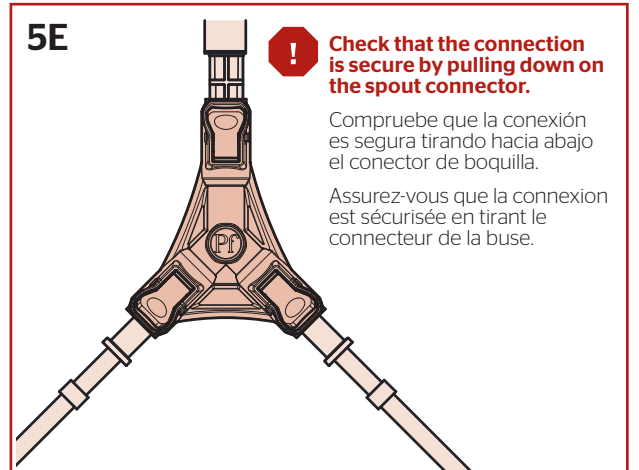

**Check that the connection is secure by pulling down on the spout connector.**

Compruebe que la conexión es segura tirando hacia abajo el conector de boquilla.

Assurez-vous que la connexion est sécurisée en tirant le connecteur de la buse.

# 6 Connect Water Supply Lines

## Conecte las tuberías de suministro de agua

### Raccorder les conduites d'alimentation en eau

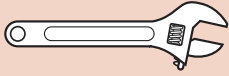

Adjustable Wrench  
Llave ajustable  
Clé à Mollette

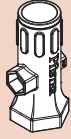

Supplied Install Tool  
Instalar la herramienta  
Outil d'installation fourni

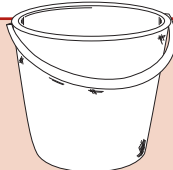

Bucket  
Balde  
Seau

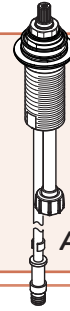

**!** **Water Supply Lines not included. Please consult manufacturer and/or its instructions for the correct method of installation of supply lines & fittings.**  
**IMPORTANT: Incorrect application of supply lines and fittings may result in the failure or leak of the supply lines and fitting.**

Las tuberías de suministro de agua no están incluidas. Consulte por favor el fabricante y/o sus instrucciones para el método correcto de instalación de líneas de suministro y de guarniciones.  
**IMPORTANT: El uso incorrecto de líneas de suministro y de guarniciones puede dar lugar a la falta o al escape de las líneas de suministro y de la guarnición.**

Les tuyaux d'arrivée d'eau ne sont pas fournis. Veuillez consulter le fabricant et/ou ses instructions pour la méthode correcte d'installation des conduites d'alimentation en eau et des accessoires.  
**IMPORTANT: Mauvaise application des lignes d'alimentation et accessoires peut entraîner la défaillance ou la fuite.**

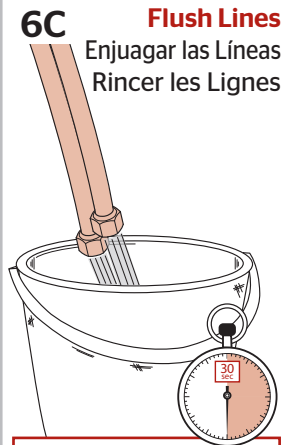
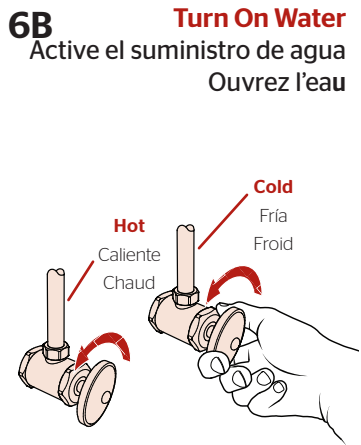
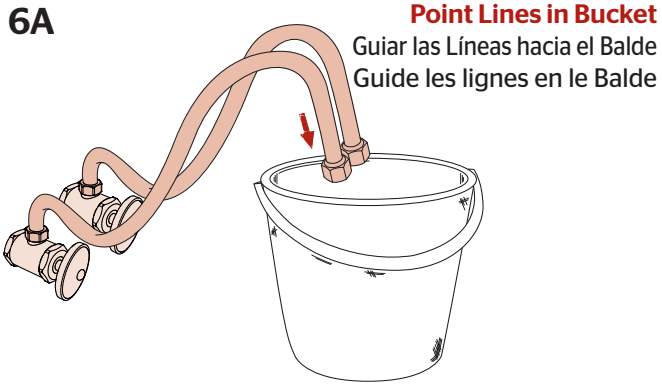
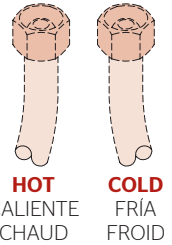

**Allow water to run for at least 30 seconds.**  
 Deje correr el agua durante al menos 30 segundos.  
 Permettez à l'eau couler au moins 30 secondes.

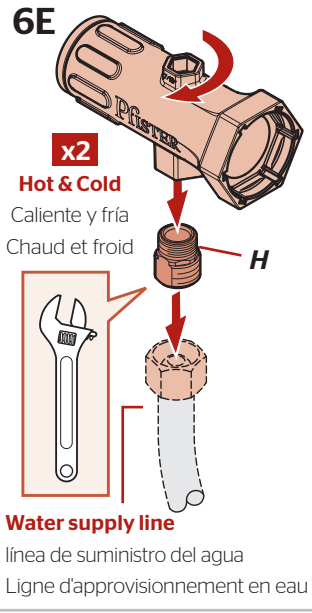
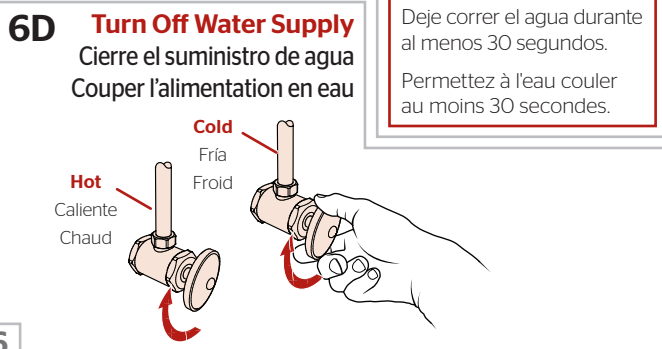

**Hand Tighten x2**  
 Apriete con la mano  
 Serrez manuellement

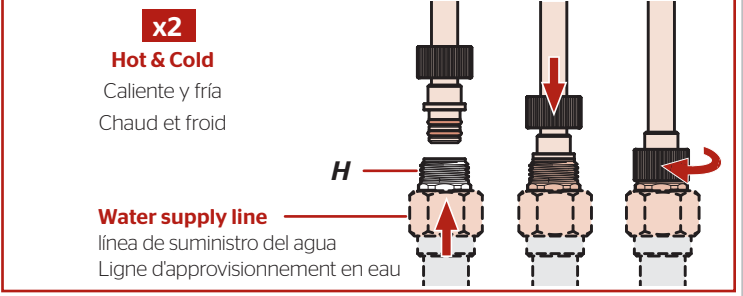
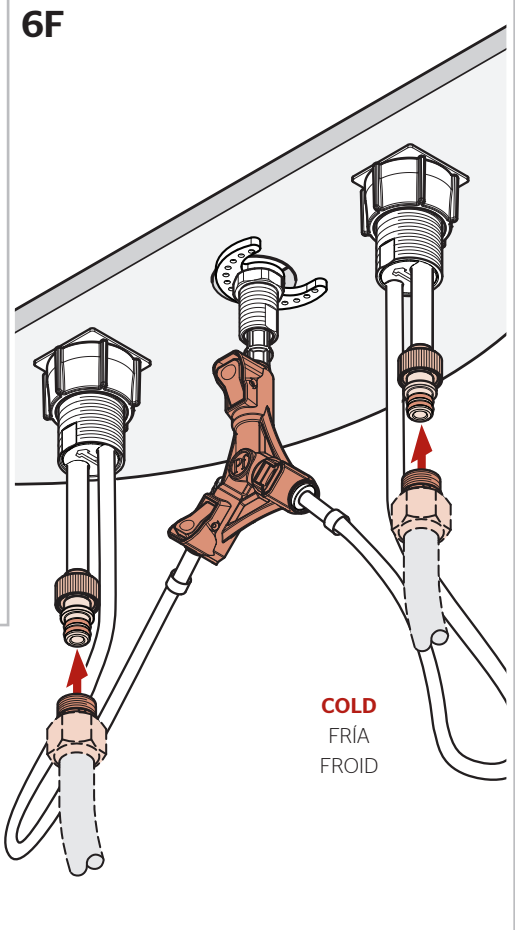

# 7 Prepare & Install Push & Seal™ Drain

## Prepare y instale cuerpo de drenaje Push & Seal™

### Préparez & installez le corps de drainage Push & Seal™

No Tools Required for This Step  
 No se necesitan herramientas para este paso  
 Pas d'outil nécessaire pour cette étape

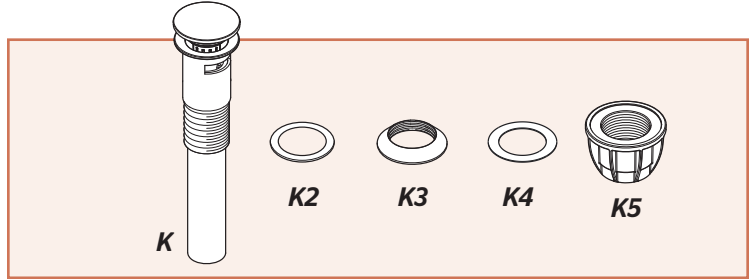

#### 7A Disassemble Pop-Up

##### Desensamble el cuerpo de drenaje

##### Démontez le corps de drainage

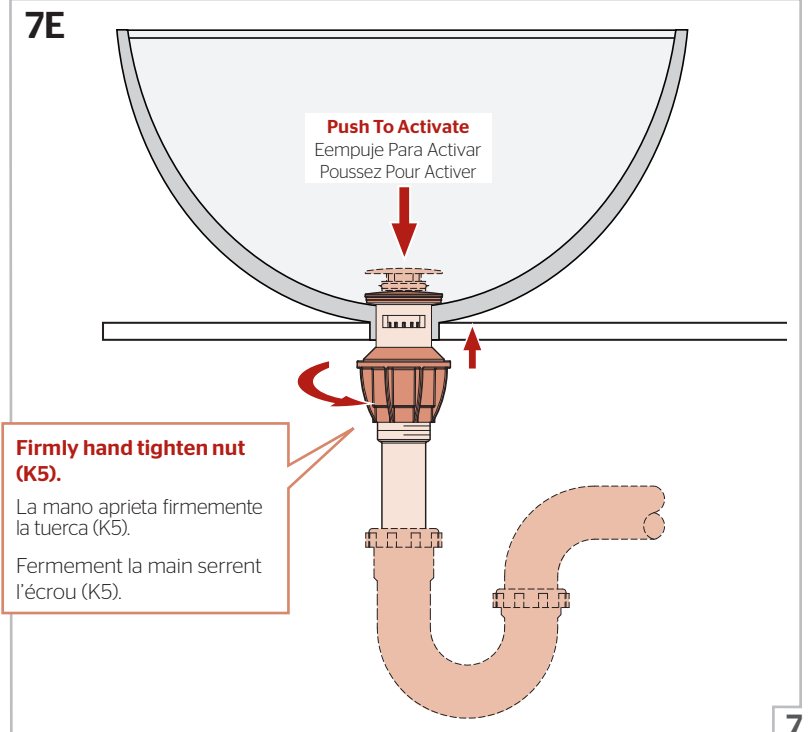
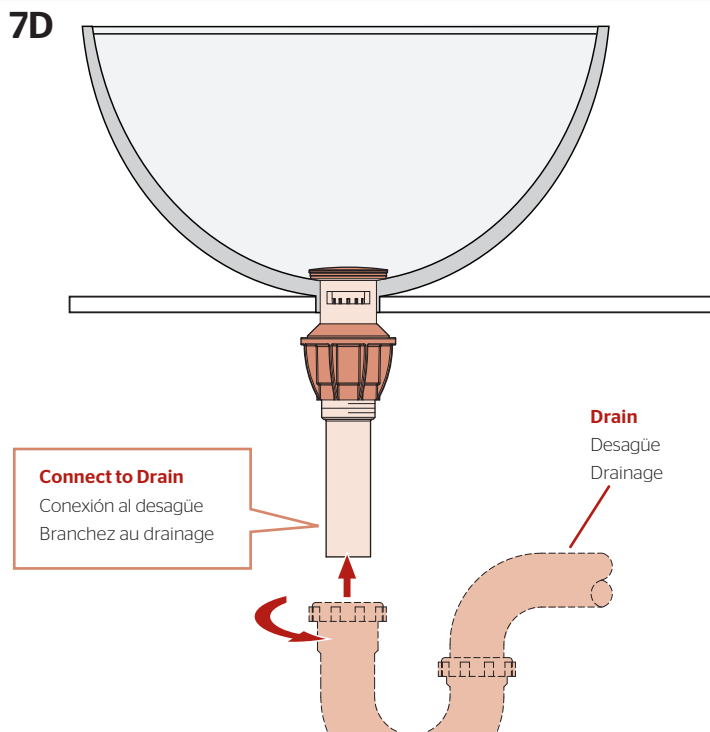
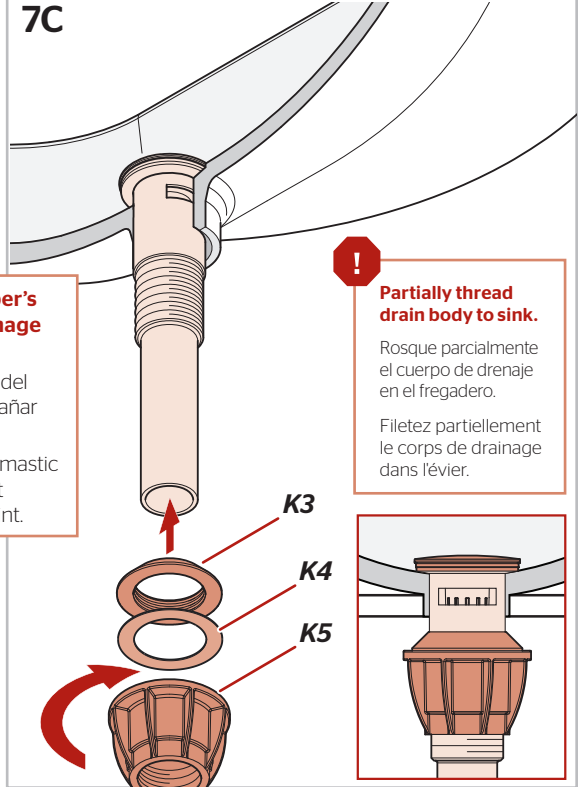
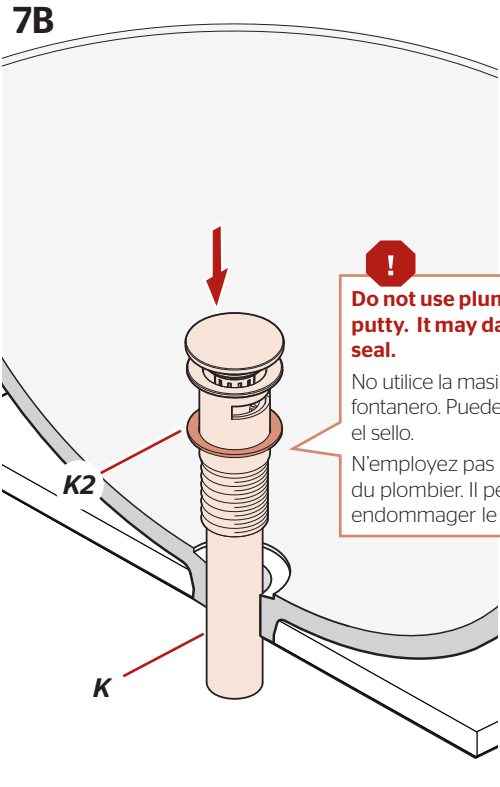
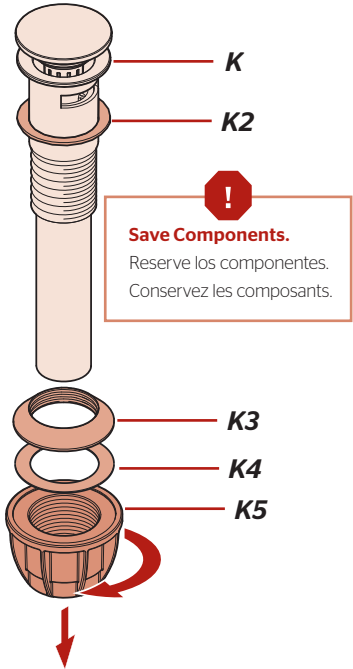

# 8

## Turn On Water & Confirm Proper Installation

Active el suministro de agua y confirme que la instalación está adecuadamente efectuada

Ouvrez l'eau et confirmez que l'installation est correcte

### 8A

#### Turn On Water Supply

Abra el suministro de agua

Ouvrez l'alimentation en eau

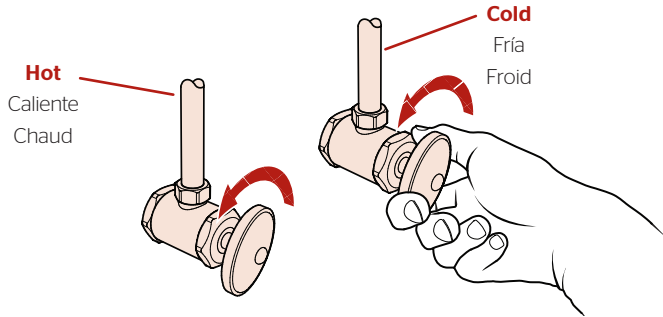

#### Check for leaks above and below the sink.

Revise si hay fugas encima y debajo del fregadero.

Assurez-vous qu'il n'y a pas de fuite au dessus ou au dessous du lavabo.

### 8B

#### Turn On Faucet

Active el grifo

Ouvrez le robinet

#### Open Slowly

Abra lentamente

Ouvrez lentement

Open  
Abierta  
Ouvverte

Hot  
Caliente  
Chaud

Cold  
Fría  
Froid

Open  
Abierta  
Ouvverte



#### Allow hot & cold water to run for at least 15 seconds each.

Deje correr el agua caliente y fría durante al menos 15 segundos cada una.

Laissez couler l'eau chaude et l'eau froide pendant au moins 15 secondes.

#### For Additional Installation Help:

Para la instalación adicionales de ayuda:

Pour les aides supplémentaires à l'installation:

# Pfister®

1-800-PFAUCET (732-8238)  
pfisterfaucets.com