

ORDER BY PART NUMBER

# ILLUSTRATED PARTS

## U.3012L U.3013X

Georgian Era™ Floor Mount Tub Filler

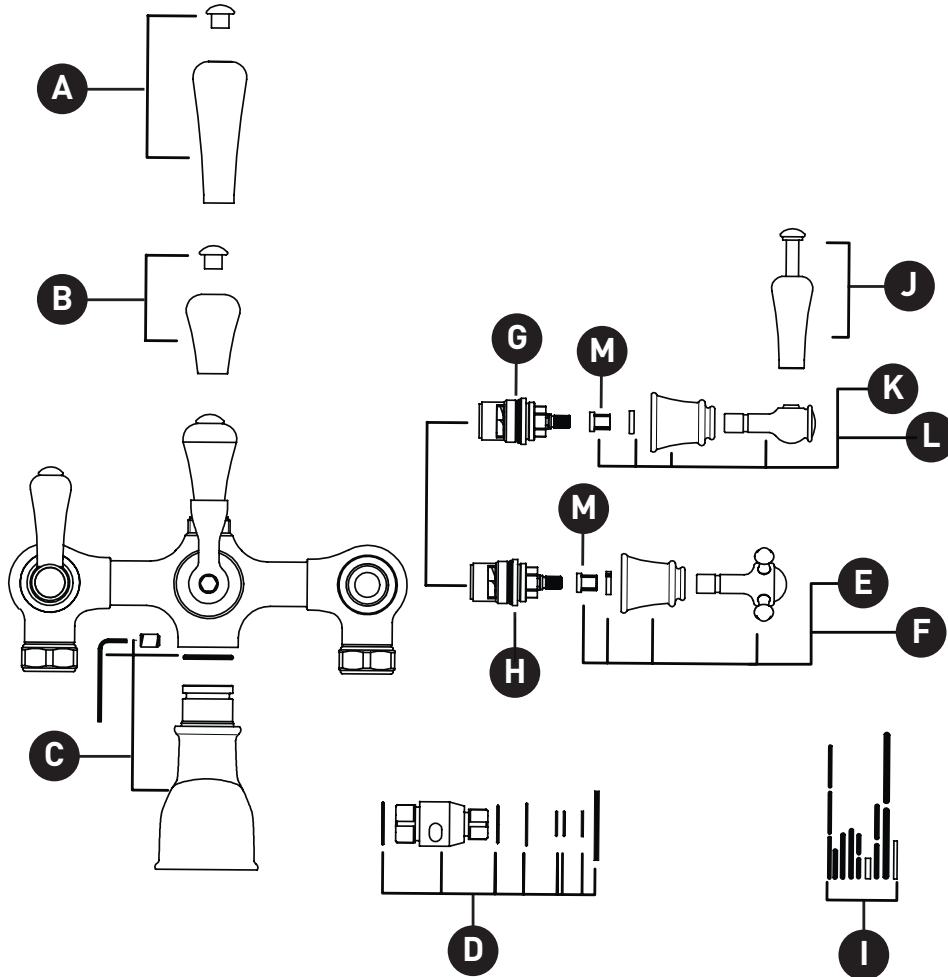

ID	Kit Number	Finish
A*	9.26761	See below
B*	9.26762	See below
C	9.20381	N/A
D	9.26500	N/A
E*	9.12796 (C)	See below
F*	9.12797 (H)	See below
G	9.13501 (L)	N/A
H	9.13500 (R)	N/A
I	9.06500	N/A
J*	9.26760	See below
K*	9.21370 (LS)	See below
L*	9.21197H (LSP)	See below
	9.21197C (LSP)	See below
M	9.15402	N/A

**\*Finish Determined by Suffix**

Finish	Description
APC	Polished Chrome
EB	English Bronze
EG	English Gold
PN	Polished Nickel
STN	Satin Nickel

For warranty or additional information, contact:

U.S.A.  
houseofrohl.com/support  
1-800-777-9762

QUEBEC / MARITIMES / WESTERN CANADA  
QUÉBEC / MARITIMES / OUEST CANADIEN  
QUEBEC / MARITIMOS / CANADA OCCIDENTAL  
houseofrohl.ca/support  
1-866-473-8442

ONTARIO  
houseofrohl.ca/support  
1-800-287-5354



ORDER BY PART NUMBER

# ILLUSTRATED PARTS

## U.6388

Floor Pillar Legs Or Supply Unions

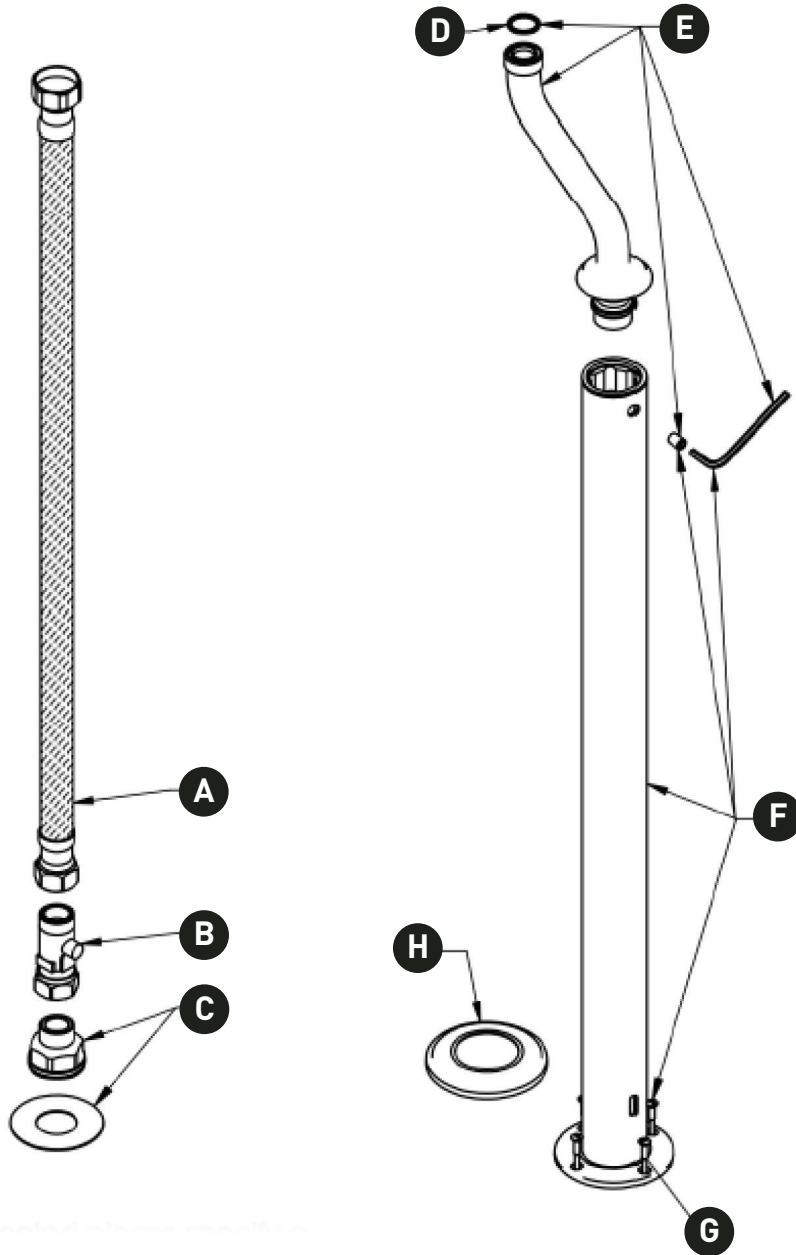

ID	Kit Number	Finish
A	9.28088	N/A
B	9.13088	N/A
C	9.03088	N/A
D	9.061153	N/A
E*	9.03089	See below
F*	9.201998	See below
G*	9.24811 (4x)	See below
H*	9.18637	See below

**\*Finish Determined by Suffix**

Finish	Description
APC	Polished Chrome
EB	English Bronze
EG	English Gold
PN	Polished Nickel
STN	Satin Nickel
ULB	Unlacquered Brass

For warranty or additional information, contact:

U.S.A.  
houseofrohl.com/support  
1-800-777-9762

QUEBEC / MARITIMES / WESTERN CANADA  
QUÉBEC / MARITIMES / OUEST CANADIEN  
QUEBEC / MARITIMOS / CANADA OCCIDENTAL  
houseofrohl.ca/support  
1-866-473-8442

ONTARIO  
houseofrohl.ca/support  
1-800-287-5354

VEUILLEZ EFFECTUER VOTRE COMMANDE  
PAR NO DE RÉFÉRENCE

# ILLUSTRATIONS DES PIÈCES

## U.3012L U.3013X

Remplisseur de baignoire à montage au sol  
Georgian Era™

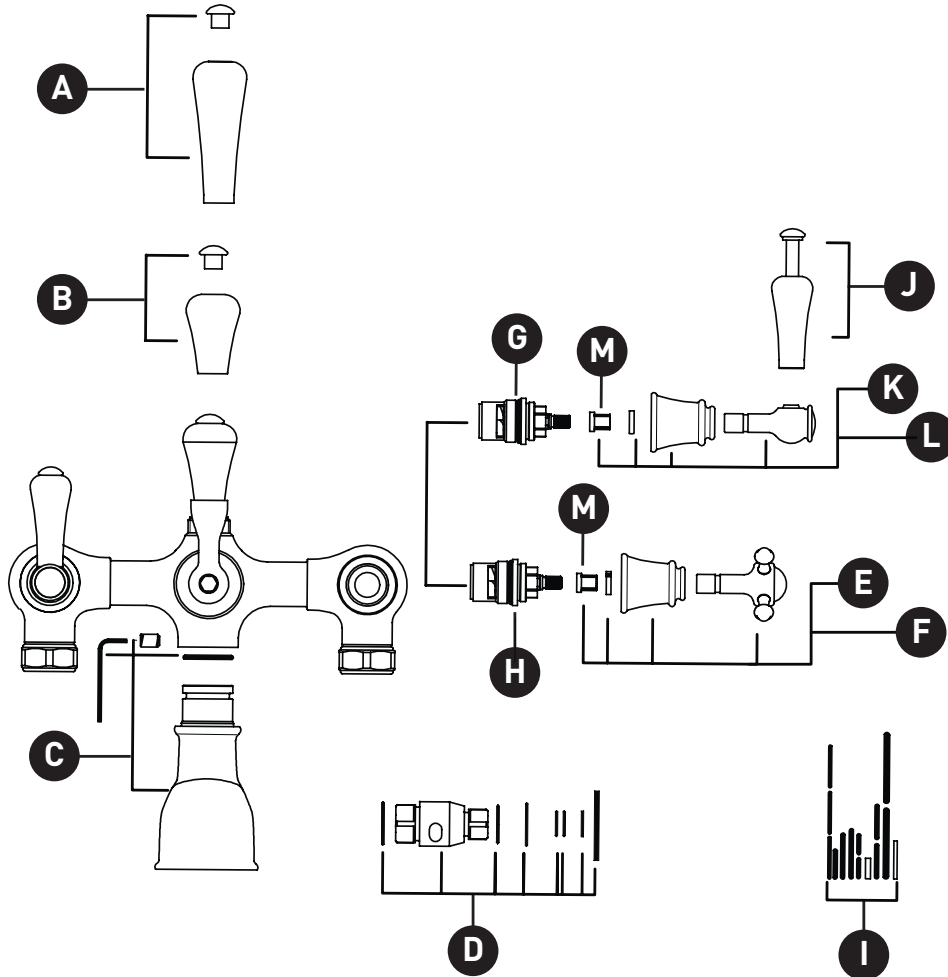

ID	Référence du kit	Finition
A*	9.26761	Voir ci-dessous
B*	9.26762	Voir ci-dessous
C	9.20381	N/A
D	9.26500	N/A
E*	9.12796 (C)	Voir ci-dessous
F*	9.12797 (H)	Voir ci-dessous
G	9.13501 (L)	N/A
H	9.13500 (R)	N/A
I	9.06500	N/A
J*	9.26760	Voir ci-dessous
K*	9.21370 (LS)	Voir ci-dessous
L*	9.21197H (LSP)	Voir ci-dessous
	9.21197C (LSP)	Voir ci-dessous
M	9.15402	N/A

**\*Finition déterminée par le Suffixe**

Finition	Description
APC	Chrome poli
EB	Bronze anglais
EG	Or anglais
PN	Nickel poli
STN	Nickel satiné

For warranty or additional information, contact:

U.S.A.  
houseofrohl.com/support  
1-800-777-9762

QUEBEC / MARITIMES / WESTERN CANADA  
QUÉBEC / MARITIMES / OUEST CANADIEN  
QUEBEC / MARITIMOS / CANADA OCCIDENTAL  
houseofrohl.ca/support  
1-866-473-8442

ONTARIO  
houseofrohl.ca/support  
1-800-287-5354

VEUILLEZ EFFECTUER VOTRE COMMANDE  
PAR NO DE RÉFÉRENCE

# ILLUSTRATIONS DES PIÈCES

## U.5380

Douchette et berceau

ID	Référence du kit	Finition
<b>A*</b>	9.28385	Voir ci-dessous
<b>B*</b>	9.27745	Voir ci-dessous
<b>C*</b>	9.27385	Voir ci-dessous
<b>D*</b>	9.26383	Voir ci-dessous

**\*Finition déterminée par le Suffixe**

Finition	Description
APC	Chrome poli
EB	Bronze anglais
EG	Or anglais
PN	Nickel poli
STN	Nickel satiné
ULB	Laiton non laqué

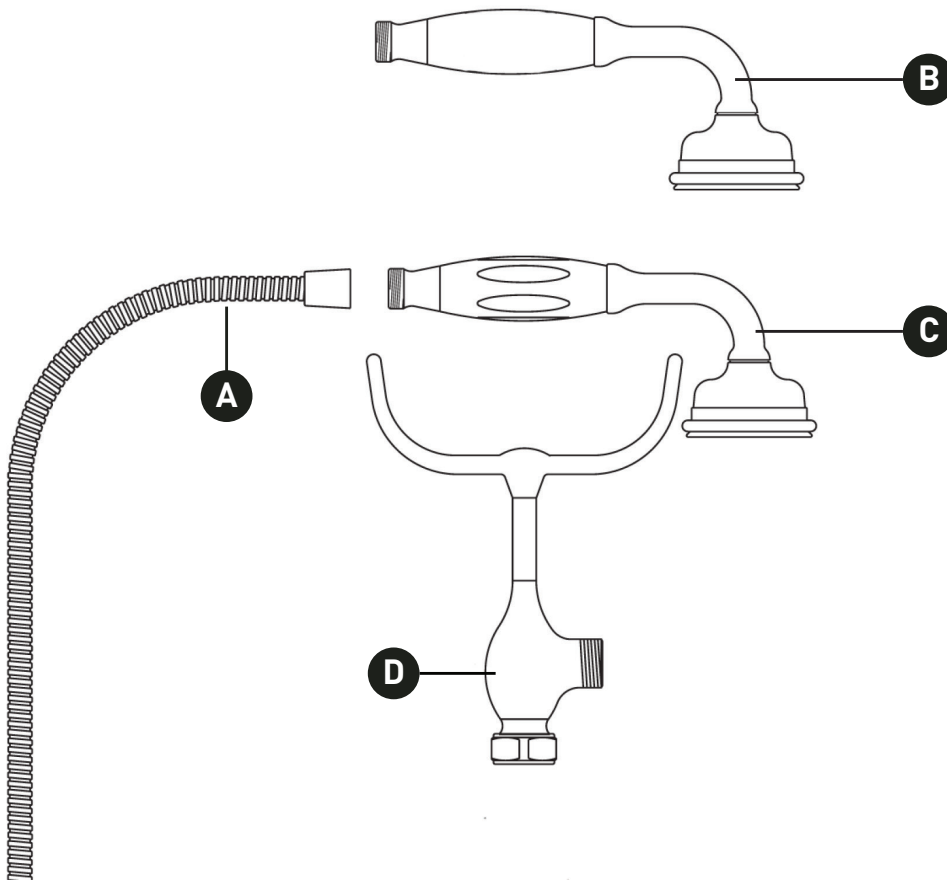

**For warranty or additional information, contact:**

U.S.A.  
houseofrohl.com/support  
1-800-777-9762

QUEBEC / MARITIMES / WESTERN CANADA  
QUÉBEC / MARITIMES / OUEST CANADIEN  
QUEBEC / MARITIMOS / CANADA OCCIDENTAL  
houseofrohl.ca/support  
1-866-473-8442

ONTARIO  
houseofrohl.ca/support  
1-800-287-5354

VEUILLEZ EFFECTUER VOTRE COMMANDE  
PAR NO DE RÉFÉRENCE

# ILLUSTRATIONS DES PIÈCES

## U.6388

Pieds de pilier de plancher ou syndicats  
d'approvisionnement

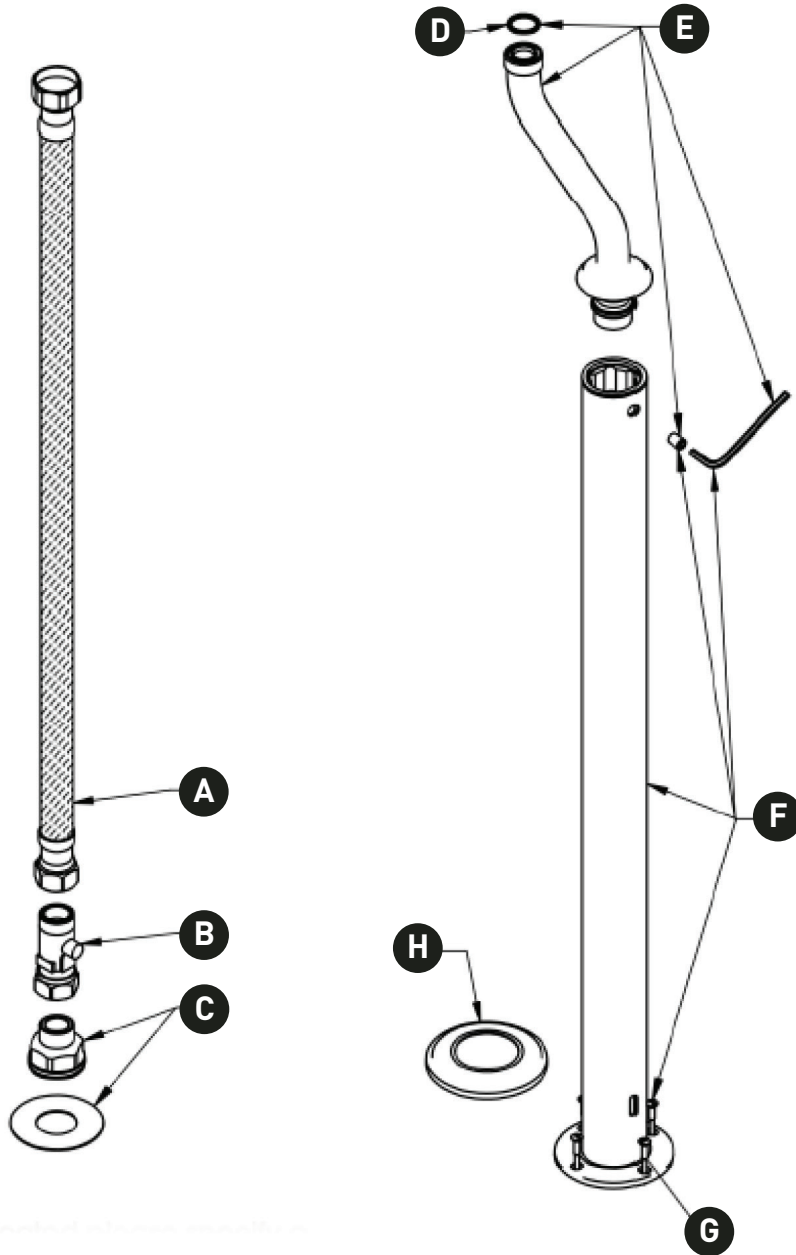

ID	Référence du kit	Finition
A	9.28088	N/A
B	9.13088	N/A
C	9.03088	N/A
D	9.061153	N/A
E*	9.03089	Voir ci-dessous
F*	9.201998	Voir ci-dessous
G*	9.24811 (4x)	Voir ci-dessous
H*	9.18637	Voir ci-dessous

### \*Finition déterminée par le Suffixe

Finition	Description
APC	Chrome poli
EB	Bronze anglais
EG	Or anglais
PN	Nickel poli
STN	Nickel satiné
ULB	Laiton non laqué

For warranty or additional information, contact:

U.S.A.  
houseofrohl.com/support  
1-800-777-9762

QUEBEC / MARITIMES / WESTERN CANADA  
QUÉBEC / MARITIMES / OUEST CANADIEN  
QUEBEC / MARITIMOS / CANADA OCCIDENTAL  
houseofrohl.ca/support  
1-866-473-8442

ONTARIO  
houseofrohl.ca/support  
1-800-287-5354

PEDIR POR NÚMERO DE REFERENCIA

# PIEZAS ILUSTRADAS

## U.3012L U.3013X

Llenador de bañera para montaje en piso Georgian Era™

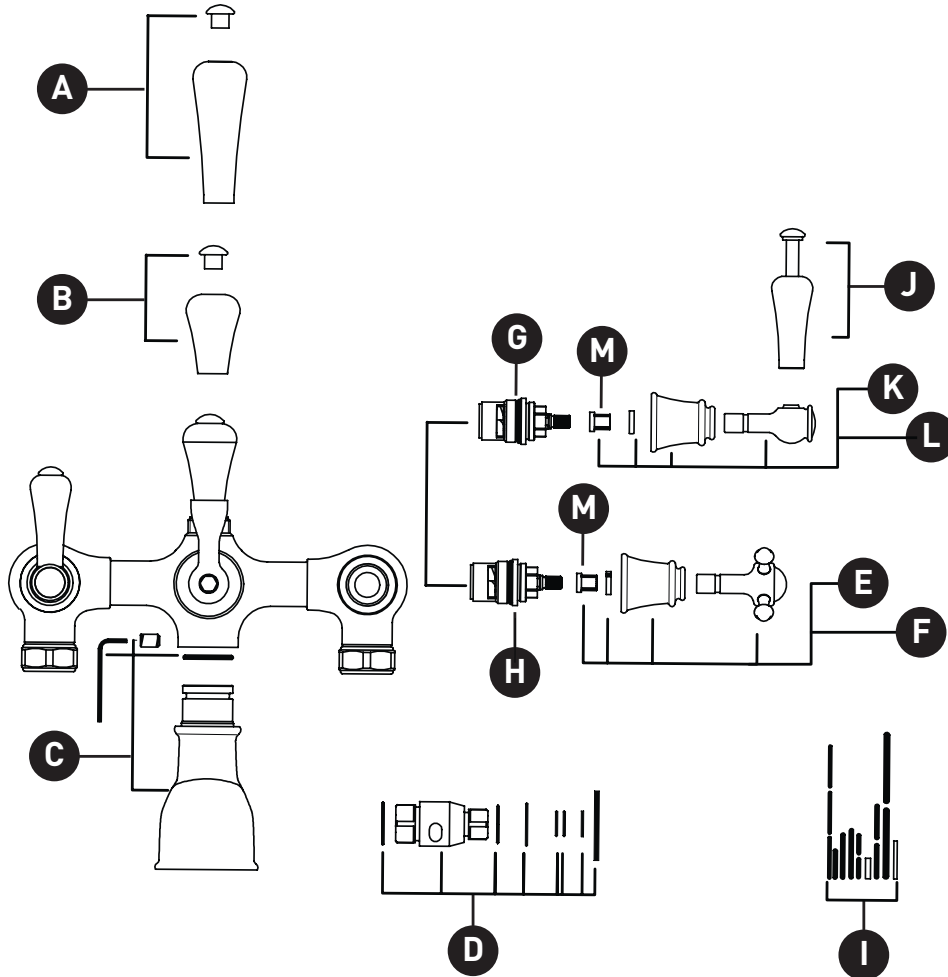

ID	Referencia del kit	Acabado
A*	9.26761	Ver más abajo
B*	9.26762	Ver más abajo
C	9.20381	N/A
D	9.26500	N/A
E*	9.12796 (C)	Ver más abajo
F*	9.12797 (H)	Ver más abajo
G	9.13501 (L)	N/A
H	9.13500 (R)	N/A
I	9.06500	N/A
J*	9.26760	Ver más abajo
K*	9.21370 (LS)	Ver más abajo
L*	9.21197H (LSP)	Ver más abajo
	9.21197C (LSP)	Ver más abajo
M	9.15402	N/A

**\*Acabado determinado por el sufijo**

Acabado	Descripción
APC	Cromo pulido
EB	Bronce Inglés
EG	Oro inglés
PN	Níquel pulido
STN	Níquel satinado

For warranty or additional information, contact:

U.S.A.  
houseofrohl.com/support  
1-800-777-9762

QUEBEC / MARITIMES / WESTERN CANADA  
QUÉBEC / MARITIMES / OUEST CANADIEN  
QUEBEC / MARITIMOS / CANADA OCCIDENTAL  
houseofrohl.ca/support  
1-866-473-8442

ONTARIO  
houseofrohl.ca/support  
1-800-287-5354





PEDIR POR NÚMERO DE REFERENCIA

# PIEZAS ILUSTRADAS

## U.6388

Patas del pilar del piso o uniones de suministro

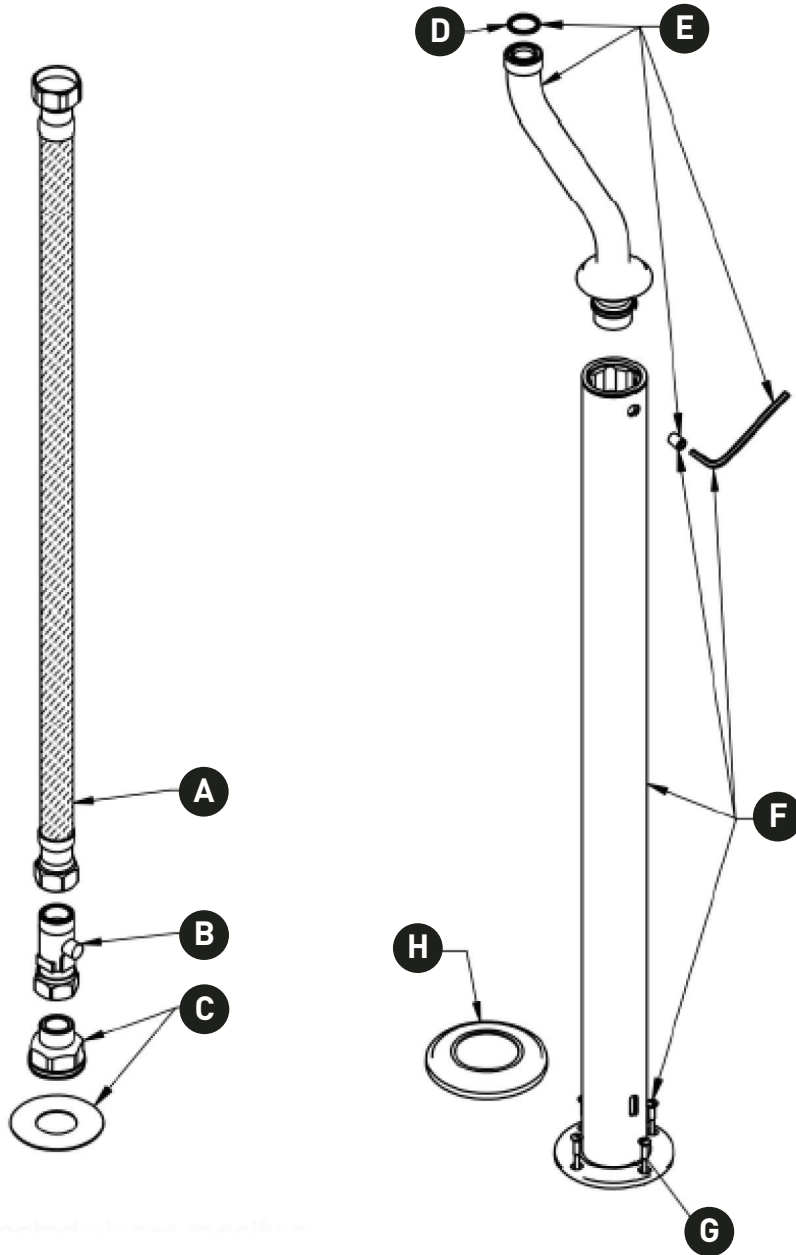

ID	Referencia del kit	Acabado
A	9.28088	N/A
B	9.13088	N/A
C	9.03088	N/A
D	9.061153	N/A
E*	9.03089	Ver más abajo
F*	9.201998	Ver más abajo
G*	9.24811 (4x)	Ver más abajo
H*	9.18637	Ver más abajo

**\*Acabado determinado por el sufijo**

Acabado	Descripción
APC	Cromo pulido
EB	Bronce Inglés
EG	Oro inglés
PN	Níquel pulido
STN	Níquel satinado
ULB	Latón sin lacar

For warranty or additional information, contact:

U.S.A.  
houseofrohl.com/support  
1-800-777-9762

QUEBEC / MARITIMES / WESTERN CANADA  
QUÉBEC / MARITIMES / OUEST CANADIEN  
QUEBEC / MARITIMOS / CANADA OCCIDENTAL  
houseofrohl.ca/support  
1-866-473-8442

ONTARIO  
houseofrohl.ca/support  
1-800-287-5354