



**OLYMPIA FAUCETS, INC.**  
 3325 S. Garfield Ave.  
 Commerce, CA 90040  
 (888) 772-7701  
 www.olympiafaucets.com

# INSTALLATION

**Tools:**



Adjustable Wrench



Plumbers Putty



Sealant Tape



Rags

**Model Number: L-747X, L-742X, L-749X**

**Warnings and Notes:**

Check with local plumbing code requirements before installation. This product should be installed by a local listed plumber. **Do not use plumbers putty on threads.**

**Installation Steps:**

Two Handle Lavatory Widespread Faucet

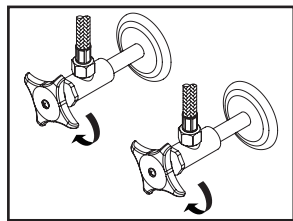

(1) Shut off the water supply. Remove old faucet. Clean mounting surface in preparation for new faucet.

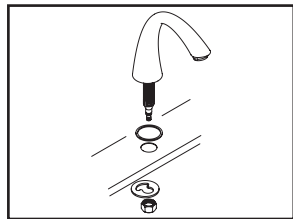

(2) Make sure gasket is under spout. Place spout in position on the sink, slide mounting bracket through spout shank from underneath the sink, thread mounting nut onto spout shank and tighten the mounting nut.

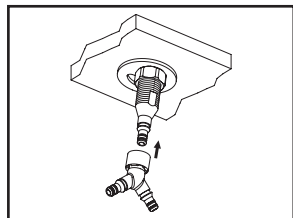

(3a) Insert Y connector into the end of quick connect adaptor on the inlet end of the spout shank. Push until a "click" sound is heard. Pull down the Y connector to test engagement.

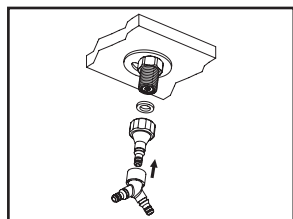

(3b) For L-749X series, with washer inside, thread and tighten quick connect adaptor to spout shank then insert Y connector into the end of quick connect adaptor on the inlet end of the spout shank. Push until a "click" sound is heard. Pull down the Y connector to test engagement.

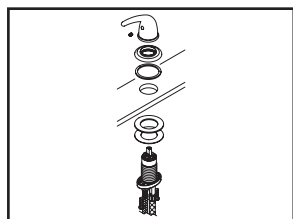

(4) Thread escutcheon with gasket from top of the side valve, attach handle to the side valve with help of 3/32" Allen wrench. Place cold and hot side valves in position on the sink, ensure handles operate in correct direction. From underneath the sink, hand-tighten locknut to the side valve. Position side valve to desired location from top. Tighten screws on locknut with the help of Phillips head screwdriver to secure side valve.

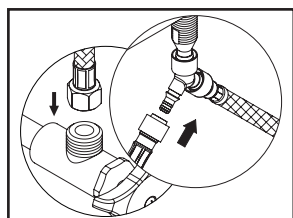

(5) Insert outlet hose of the side valve into the end of quick connect on the Y connector, push until a "click" sound is heard. Pull down the outlet hose of both side valves to test engagement. Connect inlet supply hose on cold side & hot side valve to supply stops.

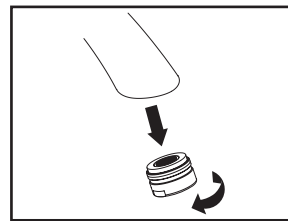

(6) Important: After installation is complete, remove the aerator. Turn on the water and allow both hot and cold water to run for at least one minute each. While water is running, check for leaks. Turn off the water and replace the aerator when finished.

**Pop-Up Drain Installation:**

**"DO NOT USE THREAD SEALANTS, TEFLON TAPE ONLY"**  
**"NO USE SELLADORES DE ROSCA, UTILIZAR SOLO CINTA DE TEFLON"**

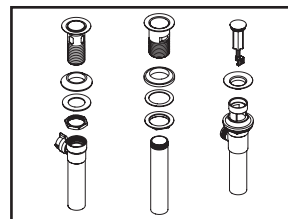

(1) a. For brass pop-up: Remove flange from drain body.  
 b. For 50/50 type pop-up: Remove rubber gasket, flat washer, and lock nut from metal drain body.

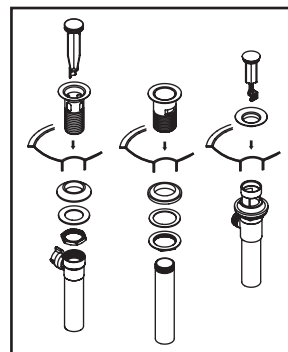

(2) a. For brass pop-up: Place a ring of plumbers putty on the bottom of the flange and apply Teflon tape on threaded tailpiece. Thread tailpiece to drain body. Insert flange through drain hole and attach drain body to flange from underneath the sink.  
 b. For 50/50 type pop-up: Place a ring of plumbers putty on the bottom of the flange. Insert drain body through drain hole. Thread rubber gasket, flat washer, and lock nut onto drain body. Apply Teflon tape only on the threaded area and attach tailpiece to drain body. **Please Note: Use Teflon tape only on all thread connection areas. Using pipe thread sealant might weaken material structure and cause leaks.**

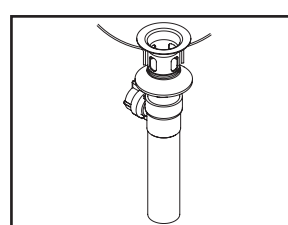

(3) Ensure the pivot rod hole on the pop-up body faces toward the back of the sink. Tighten the lock nut securely with a wrench.

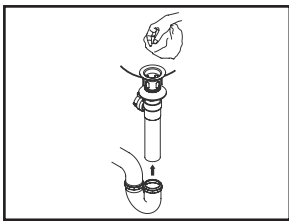

(4) Connect pop-up tail piece to the trap (check manufacturer's instruction for installation) and remove the excess plumbers putty.

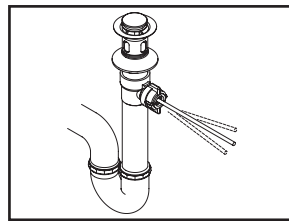

(6) Push pivot rod down and insert drain plug carefully. Test to ensure drain plug works properly.

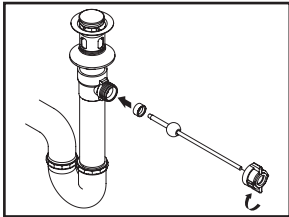

(5) Remove pivot rod nut from pop-up body and ensure the washer is in place. Insert pivot rod and tighten rod nut back to pop-up body.

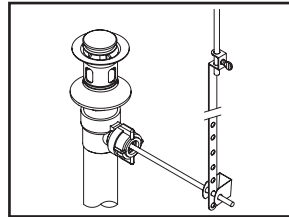

(7) Connect lift rod strap to pivot rod by using clip. Tighten thumbscrew to connect lift rod strap to pop-up lift rod.

## Exploded Drawing (L-747X):

\* Note: Please specify finish/color when ordering.

	ITEM #	DESCRIPTION
I	OP-430001	Spout Mounting Kit
J	OP-230008*	"J" Style Spout
K	OP-630004*	50/50 Pop-Up Drain Assembly (For L-7470)
L	OP-630002*	Brass Pop-Up Drain Assembly (For L-7472)
1	OP-490029	3/32" Allen Screw
2	OP-490065*	1.2 GPM Aerator
3	OP-430028	Gasket

	ITEM #	DESCRIPTION
A	OP-490011	3/32" Allen Wrench
B	OP-490020C, H	Red/Blue Index Button
C	OP-190015C, H*	Lever Handle-Cold, Hot
D	OP-430027*	Valve Escutcheon & Gasket
E	OP-530006	Valve Mounting Kit
F	OP-490006	Bonnet Nut
G	OP-330002C, H	Ceramic Stem-Cold, Hot
H	X-4300101	'Y' Connector

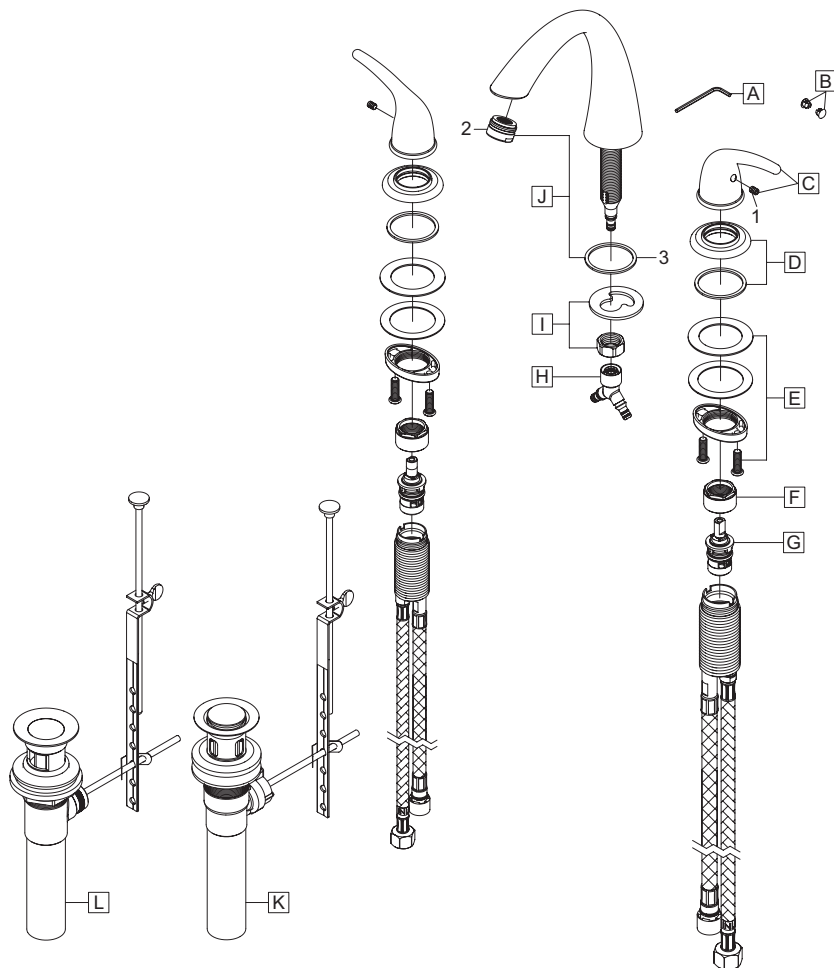

## Exploded Drawing (L-742X, L-743X):

\* Note: Please specify finish/color when ordering.

	ITEM #	DESCRIPTION
A	OP-490011	3/32" Allen Wrench
B	OP-190016C, H*	Lever Handle-Cold, Hot
C	OP-430036*	Valve Escutcheon & Gasket
D	OP-530006	Valve Mounting Kit
E	OP-490006	Bonnet Nut
F	OP-330002C, H	Ceramic Stem-Cold, Hot
G	X-4300101	'Y' Connector
H	OP-430001	Spout Mounting Kit
I1	OP-230009*	Gooseneck Style Spout (For L-742X)
I2	OP-230014*	90 DEGREE SPOUT (For L-743X)
J	OP-630008*	50/50 Pop-Up Drain Assembly (For L-7420)
K	OP-630009*	Brass Pop-Up Drain Assembly (For L-7422)
1	OP-420047	3/32" Allen Screw
2	OP-490062*	1.2 GPM Aerator & Tool
3	OP-430037*	Spout Escutcheon & Gasket

