



OLYMPIA FAUCETS, INC.
 3325 S. Garfield Ave.
 Commerce, CA 90040
 (888) 772-7701
 www.olympiafaucets.com

INSTALLATION

Tools:



Adjustable Wrench



Plumbers Putty



Sealant Tape



Rags

Model Number: L-7330, L-7332, L-7372



Warnings and Notes:

Check with local plumbing code requirements before installation.
 This product should be installed by a local listed plumber.
Do not use plumbers putty on threads.

Installation Steps:

Two Handle Lavatory Widespread Faucet

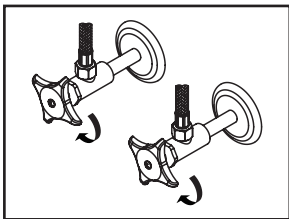

(1) Shut off water supplies. Remove old faucet. Clean mounting surface in preparation for new faucet.

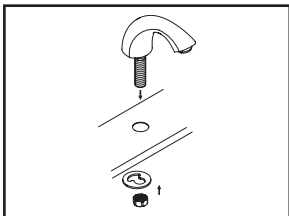

(2) Place spout in position on the sink, slide mounting bracket through spout shank from underneath of the sink, thread mounting nut onto spout shank and tighten the mounting nut.

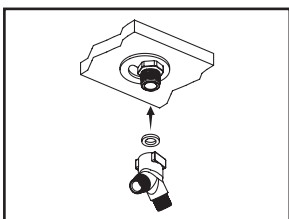

(3) Place washer inside the "Y" connector, thread "Y" connector to the spout shank.

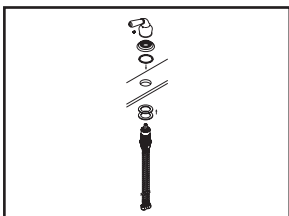

(4) Thread escutcheon with gasket from top of the side valve, attach handle to the side valve with help of 3/32" Allen wrench. Place cold and hot side valves in position on the sink, ensure handles operation turn in correct direction.

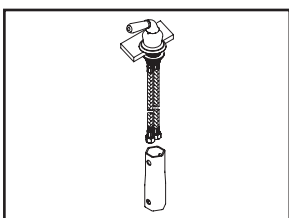

(5) Slide rubber and steel washer through side valve from underneath of the sink, thread and tighten mounting nut onto side valve with help of 1-11/32" socket. Repeat the same procedure on the other side valve. Connect both cold and hot side valve outlet hoses to "Y" connector.

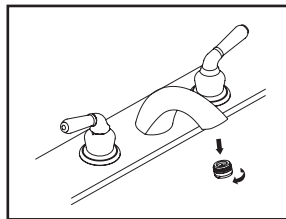

(6) Important: After installation is complete, remove aerator. Turn water supplies on and allow both hot and cold water to run at least one minute each. While water is running, check for leaks. Turn off water and replace aerator.

Pop-up Drain Installation:

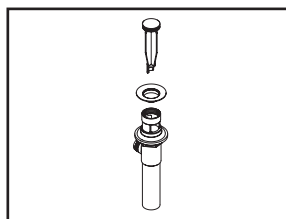

(1) Remove pop-up flange from body

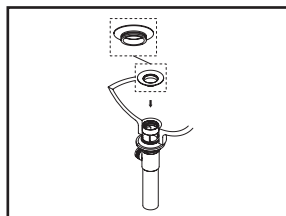

(2) Place a ring of plumbers putty on the bottom of flange.

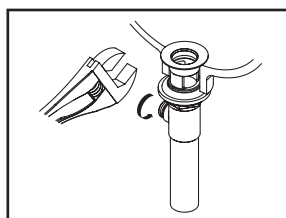

(3) Insert pop-up flange through drain hole and attach flange to body. Use Teflon tape to thread tail piece to Pop-up drain body. Ensure the pop-up outlet faces towards the back of the sink. Tighten the locknut securely with a wrench. Do not overtighten.

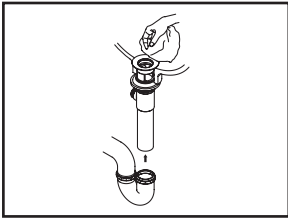

(4) Remove the excess plumber's putty. Connect the trap (check manufacturer's instructions for installation).

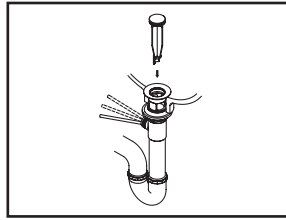

(6) Push pivot rod down, insert drain plug carefully. Test to ensure drain plug works properly.

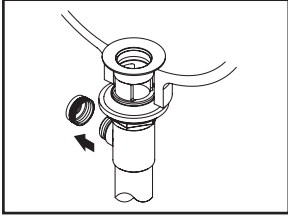

(5) Remove pivot rod nut from pop-up body, ensure the washers is in place, insert pivot rod, tighten pivot rod nut back to pop-up body.

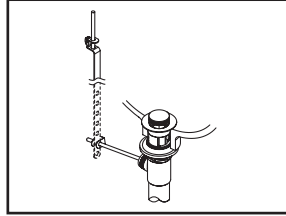

(7) Connect lift rod strap to pivot rod by using clip. Tighten the thumbscrew to connect lift rod strap to pop-up lift rod.

Exploded Drawing:

* Note: Please specify finish/color when ordering.

	ITEM #	DESCRIPTION
A	OP-490011	3/32" Allen Wrench
B1	OP-190010C, H*	Lever Handle-Cold, Hot (For L-733X)
B2	OP-190015C, H*	Lever Handle-Cold, Hot (For L-7372)
C	OP-490007*	Escutcheon and Gasket
D	OP-490006	Bonnet Nut
E	OP-390004	Cartridge-Brass Post
F	OP-590002	Valve Mounting Kit
G	OP-490041	Springs and Seats
H	OP-490009	"Y" Connector & Washer
I	OP-430001	Spout Mounting Kit
J	OP-230001*	"C" Style Spout
K	OP-630004*	50/50 Drain Assembly(For L-7330)
L	OP-630002*	Brass Pop-Up Drain Assembly (For L-7332, L-7372)
1	OP-490029	3/32" Allen Screw
2	OP-490065*	1.2 GPM Aerator

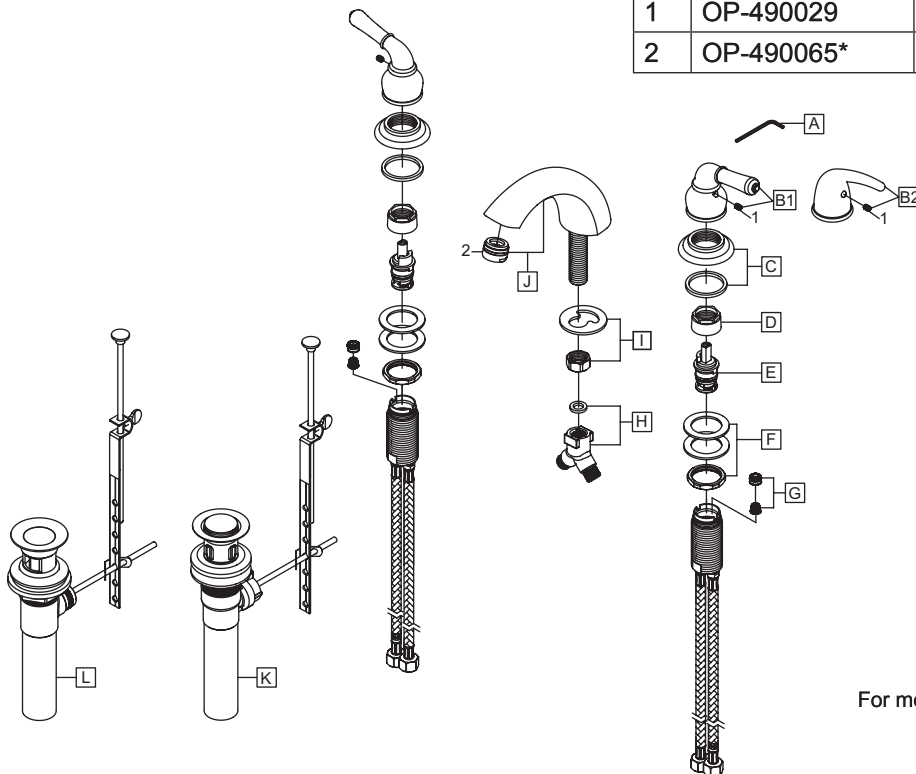

OLYMPIA

For more care information or trouble shooting inquiries about your Olympia product, Please call:
OLYMPIA FAUCETS, INC. (888) 772-7701
 Monday-Friday 8 AM to 8 PM EST (5 AM to 5 PM PST)
www.olympiafaucets.com