



OLYMPIA FAUCETS, INC.
3325 S. Garfield Ave.
Commerce, CA 90040
(888) 772-7701
www.olympiafaucets.com

INSTALLATION

Tools:



Adjustable Wrench



Plumbers Putty



Sealant Tape



Rags

**Model Number: L-7240, L-7241, L-7242, L-7270
L-7271, L-7272**



Warnings and Notes:

Check with local plumbing code requirements before installation.
This product should be installed by a local listed plumber.
Do not use plumbers putty on threads.

Installation Steps:

Two Handle Lavatory Faucet

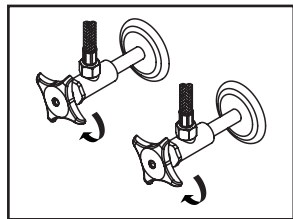

(1) Shut off water supplies. Remove old faucet. Clean mounting surface in preparation for new faucet.

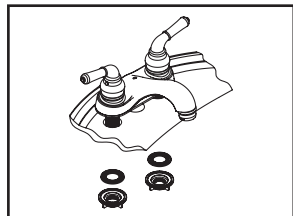

(2) Place the faucet in position on the sink. Install washer on shanks and tighten with locknut.

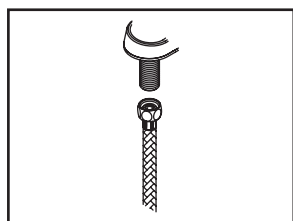

(3) When using stainless steel braided faucet supply hose, this faucet requires one end of the supply hose to have a 1/2" female IPS connection. The other end of this supply hose must match the thread on the water supply valve under your sink. Once you've identified the required size, carefully follow the manufacturer's installation instructions for each hose.

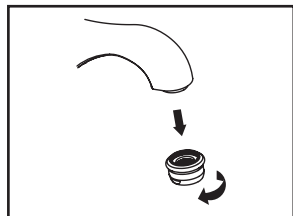

(4) Important: After installation is complete, remove aerator. Turn water supplies on and allow both hot and cold water to run at least one minute each. While water is running, check for leaks. Turn off water and replace aerator.

Pop-up Drain Installation:

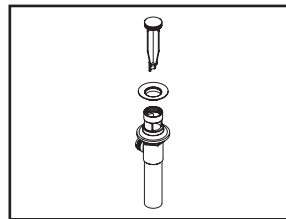

(1) Remove pop-up flange from body.

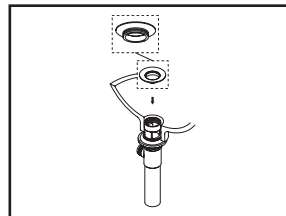

(2) Place a ring of plumbers putty on the bottom of flange.

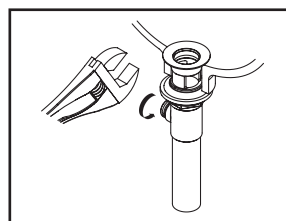

(3) Insert pop-up flange through drain hole and attach flange to body. Use Teflon tape to thread tail piece to Pop-up drain body. Ensure the pop-up outlet faces towards the back of the sink. Tighten the locknut securely with a wrench. Do not overtighten.

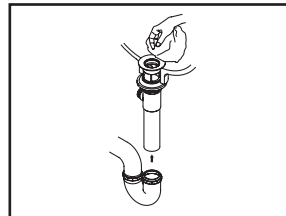

(4) Remove the excess plumbers putty. Connect the trap (check manufacturer's instructions for installation).

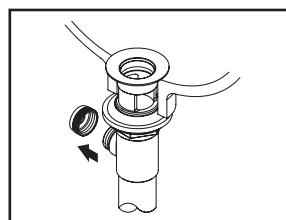

(5) Remove pivot rod nut from pop-up body, ensure the washers is in place, insert pivot rod, tighten pivot rod nut back to pop-up body.

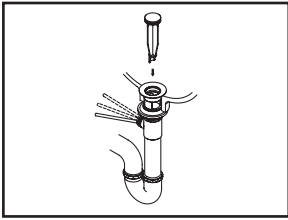

(6) Push pivot rod down, insert drain plug carefully. Test to ensure drain plug works properly.

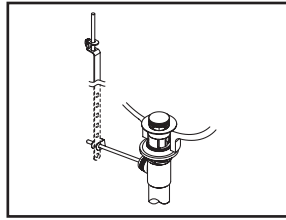

(7) Connect lift rod strap to pivot rod by using clip. Tighten the thumbscrew to connect lift rod strap to pop-up lift rod.

Exploded Drawing:

* Note: Please specify finish/color when ordering.

	ITEM #	DESCRIPTION
A1	OP-190010C,H*	Lever Handle Cold, Hot (For L-724X)
A2	OP-190015C,H*	Lever Handle Cold, Hot (For L-727X)
B	OP-490040	Bonnet Nut
C	OP-390004	Cartridge-Brass Post
D	OP-490041	Springs & Seats
E	OP-590003	Mounting Hardware
F	OP-590001	Supply Nut
G	OP-430030*	1.2 GPM Aerator
H	OP-630004*	50/50 Pop-Up Drain Assembly (For L-7240,L-7270)
I	OP-630002*	Brass Pop-Up Drain Assembly (For L-7242,L-7272)
J	OP-430005	Hole Cover (For L-7241,L-7271)
1	OP-490029	3/32" Allen Screw

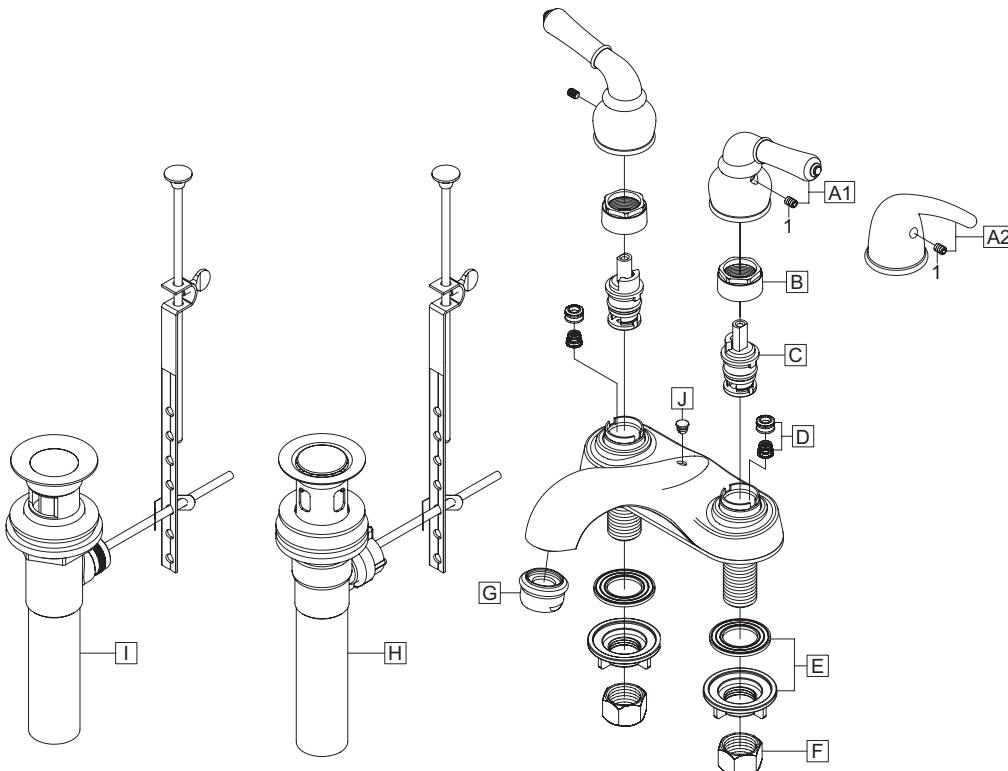

OLYMPIA

For more care information or trouble shooting inquiries about your Olympia product, Please call:
OLYMPIA FAUCETS, INC. (888) 772-7701
 Monday-Friday 8 AM to 8 PM EST (5 AM to 5 PM PST)
www.olympiafaucets.com