

PARTS BREAKDOWN SHEET



i2 SINGLE HANDLE PULL-DOWN KITCHEN FAUCET



Model #: _____
Specific Features: _____
Project Name: _____
Submitted For: _____
Date: _____

- Lever Handle
- Pull-Down Swivel 360°
- Pull-Down Head with 2 Spray Patterns Swivel 360°
- 7-5/8" Reach, 8-5/8" From Deck to Aerator
- Ceramic Disc Cartridge
- 1 or 3-Hole 8" Installation
- Easy-Install 30" Flex Supply Lines With 3/8" Connections
- Deck Cover Plate Included

K-5020 SHOWN **ADA**

Model #	Features	Finish	
K-5020*		CP	
K-5020-BN*		PVD BN	
K-5025*		CP	
K-5025-BN*		PVD BN	

* Aerator limited to 1.8 GPM Flow Rate

Olympia products are engineered and manufactured to meet the following standards and codes:

- ASME A112.18.1
- ANSI A117.1
- IAPMO LISTED (For K-5020)
- ANSI / NSF 61, SECTION 9
- CONTAINS NO MORE THAN 0.25% WEIGHTED AVERAGE LEAD CONTENT

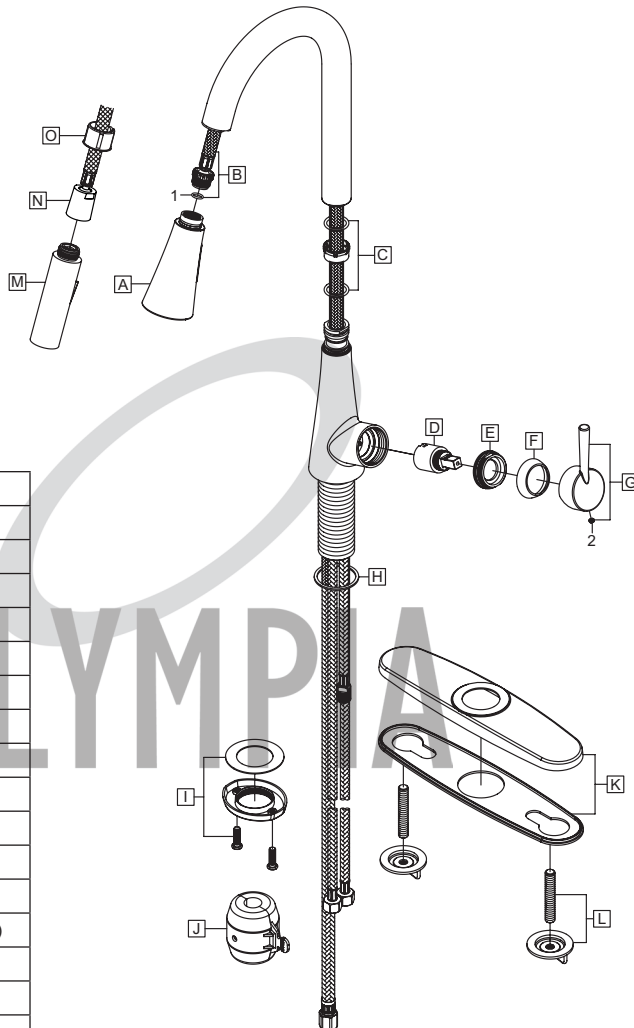

ITEM #	DESCRIPTION
A	OP-420054* Pull-Down Spray Head (For K-5020)
B	OP-420055 Spray Hose and O-ring (For K-5020)
C	OP-420056 Spout Repair Kit
D	OP-390003 Ceramic Disc Cartridge
E	OP-420057 Retainer Nut
F	OP-420058* Cap
G	OP-120004* Lever Handle
H	OP-420059 Washer
I	OP-520015 Mounting Kit with Screws
J	OP-420070 Click Weight
K	OP-420045* Deck Plate
L	OP-520003 Mounting Kit
M	X-4200181* 1.8 GPM Pull-Down Spray Head (For K-5025)
N	X-4200111 Spray Hose (For K-5025)
O	X-4200178 Spray Head Support (For K-5025)
1	OP-420060 O-Ring (For K-5020)
2	OP-420061 Allen Screw

* Note- Please Specify finish\color code while ordering.

PARTS BREAKDOWN SHEET



Model Number: K-5025

* Note: Please specify finish/color when ordering.

* Note - Parts I includes only on the product purchased after March 2019.

	ITEM #	DESCRIPTION
A	OP-420054*	1.8 GPM Spray Head (For K-5020)
	OP-420068*	1.5 GPM Spray Head (For K-5020)
B	OP-420074	Spray Hose and O-ring (For K-5020)
C	OP-420056	Spout Repair Kit
D	OP-390003	Ceramic Disc Cartridge
E	OP-420057	Retainer Nut
F	OP-420058*	Cap
G	OP-120004*	Lever Handle
H	OP-420059	Washer
I	X-4200199	Quick Connect
J	OP-520015	Locknut with Screws
K	OP-420070	Weight
L	OP-420045*	Deck Plate & Base Gasket
M	OP-520003	Mounting Bolts & Nuts
N	X-4200181*	1.8 GPM Spray Head (For K-5025)
O	X-4200197	Spray Hose (For K-5025)
P	X-4200178	Spray Head Support (For K-5025)
1	OP-420060	O-Ring (For K-5020)
2	OP-420061	Allen Screw
3	OP-420075	Washer (For K-5025)

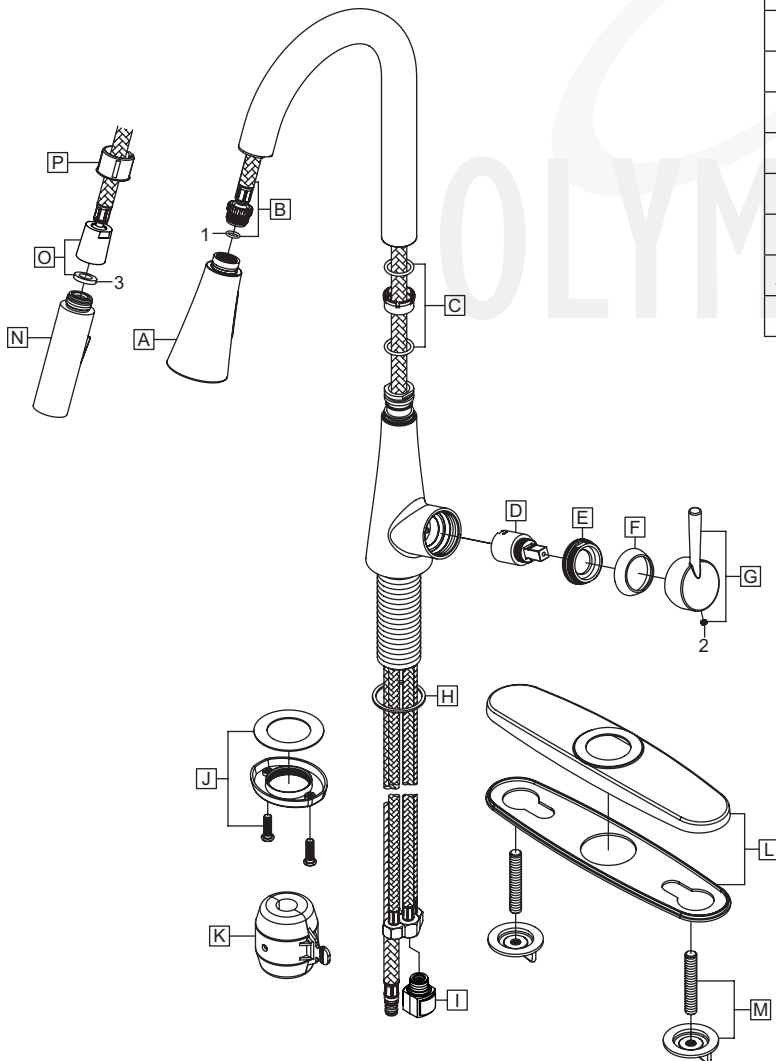

PARTS BREAKDOWN SHEET



Model Number: K-5020, K-5025

* Note: Please specify finish/color when ordering.
 * Note - Part C includes only on the product purchased after September 2019.

	ITEM #	DESCRIPTION
A	OP-420054*	1.8 GPM Spray Head (For K-5020)
	OP-420068*	1.5 GPM Spray Head (For K-5020)
B	OP-420074	Spray Hose and O-ring (For K-5020)
C	X-4200190	Spout Repair Kit
D	OP-390003	Ceramic Disc Cartridge
E	OP-420057	Retainer Nut
F	OP-420058*	Cap
G	OP-120004*	Lever Handle
H	OP-420059	Washer
I	X-4200199	Quick Connect
J	OP-520015	Locknut with Screws
K	OP-420070	Weight
L	OP-420045*	Deck Plate & Base Gasket
M	OP-520003	Mounting Bolts & Nuts
N	X-4200181*	1.8 GPM Spray Head (For K-5025)
O	X-4200197	Spray Hose (For K-5025)
P	X-4200178	Spray Head Support (For K-5025)
1	OP-420060	O-Ring (For K-5020)
2	OP-420061	Allen Screw
3	OP-420075	Washer (For K-5025)

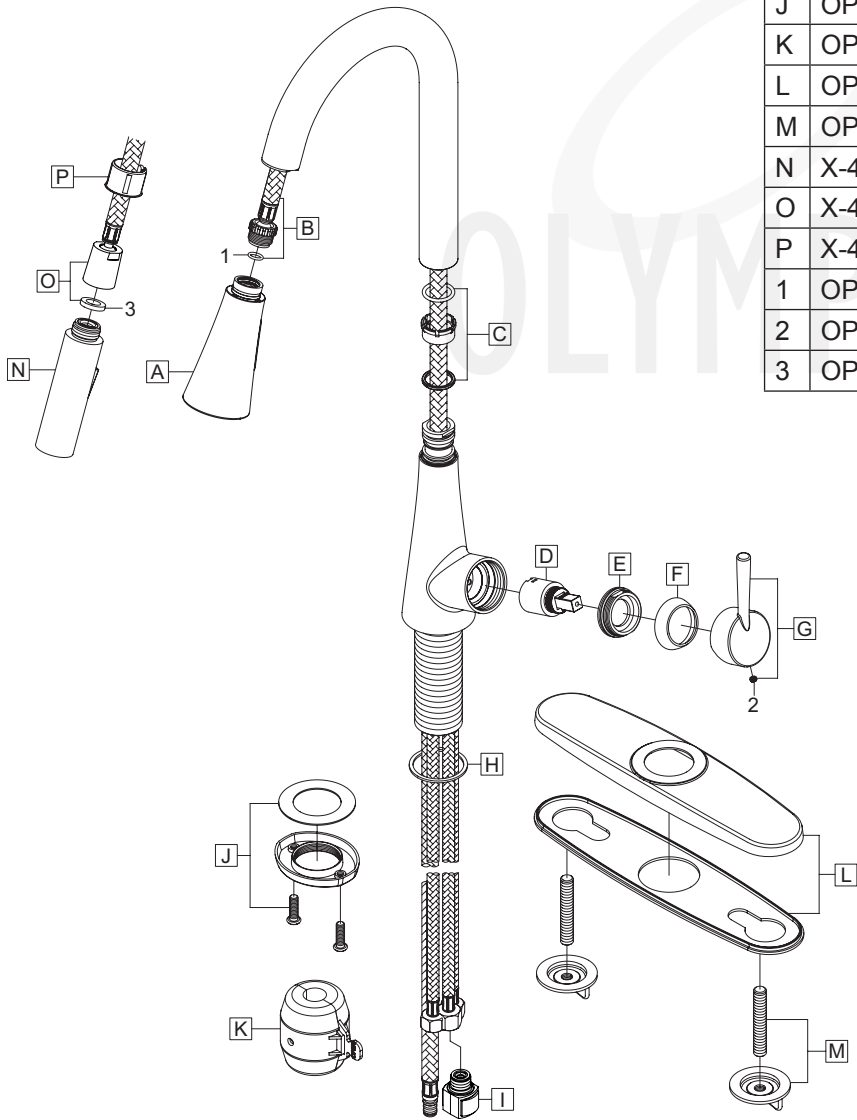

PARTS BREAKDOWN SHEET



Model Number: K-5020, K-5025

* Note: Please specify finish/color when ordering.

* Note: 1.8 GPM Spray Head replaced by 1.5 GPM Spray Head for product purchased after March 2020.

	ITEM #	DESCRIPTION
A	OP-420068*	1.5 GPM Spray Head (For K-5020)
B	OP-420074	Spray Hose and O-ring (For K-5020)
C	X-4200190	Spout Repair Kit
D	OP-390003	Ceramic Disc Cartridge
E	OP-420057	Retainer Nut
F	OP-420058*	Cap
G	OP-120004*	Lever Handle
H	OP-420059	Washer
I	X-4200199	Quick Connect
J	OP-520015	Locknut with Screws
K	OP-420070	Weight
L	OP-420045*	Deck Plate & Base Gasket
M	OP-520003	Mounting Bolts & Nuts
N	X-4200194*	1.5 GPM Spray Head (For K-5025)
O	X-4200197	Spray Hose (For K-5025)
P	X-4200178	Spray Head Support (For K-5025)
1	OP-420060	O-Ring (For K-5020)
2	OP-420061	Allen Screw
3	OP-420075	Washer (For K-5025)

