



## Installation Instructions For Pre-Attached Long Plates

### Passage and Privacy

*With step-by-step Installation Pictograms & Drilling Template*

Applies to:

Craftsman • Mission • Prairie • Deco • New York • Egg & Dart  
Meadows • Victorian



**Tools Required: #2 Phillips Screwdriver, electric drill, 7/64" drill bit**

### Door Handing - Long Plates

Door handing is critical for Split-Finish, or Split-Design products in the privacy function. And, it's helpful positioning the latch tongue in relation to the strike plate.

**Inside of Door** - The **Inside** of a door refers to the side of the door that faces the room. For example, for a bedroom door on a hallway, the **Inside** of the door would face the bedroom.

**Outside of Door** - The **Outside** of a door refers to the side of the door that faces away from the room. The **Outside** of a door is generally more visible to visitors, and therefore a rosette on this side of the door has no visible screws. For example, on a bedroom door, the **Outside** would face the hallway.

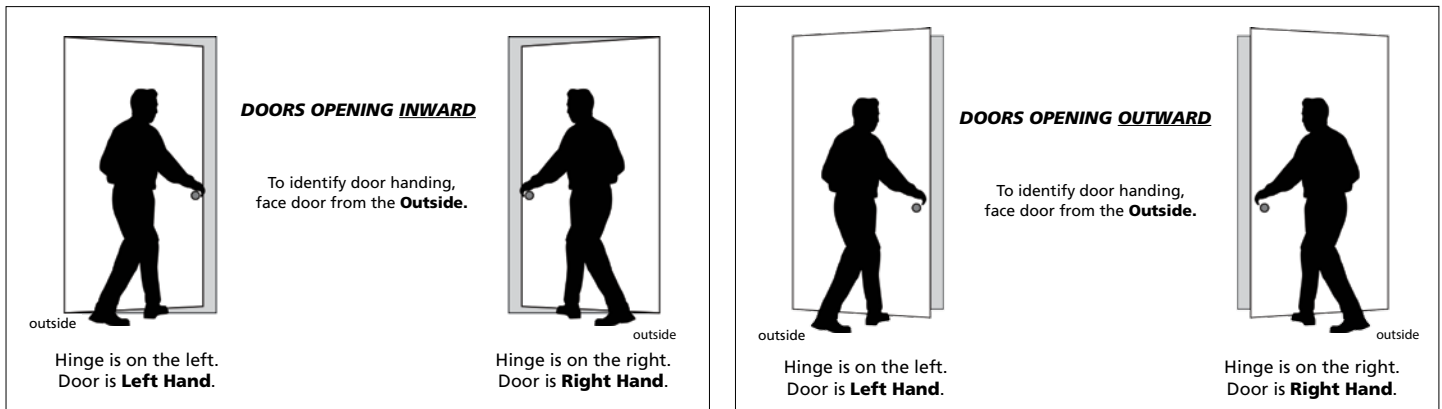

### INSTALLATION RULES:

- 1) Long Plate wood mounting screws should **NOT** be installed using power tools.
- 2) Privacy pin holes are next to the door side containing the latch.
- 3) Latch tongues have a beveled side, and this side should contact the curved end of the face plate, and curved end of the strike plate.  
(See **\*Latch Tongue Note** on page 3.)



# Exploded Drawing for Pre-Attached Long Plate Passage/Privacy

\* Note: Craftsman and Mission Plates attach to door with 3/4" Oval Head Screws

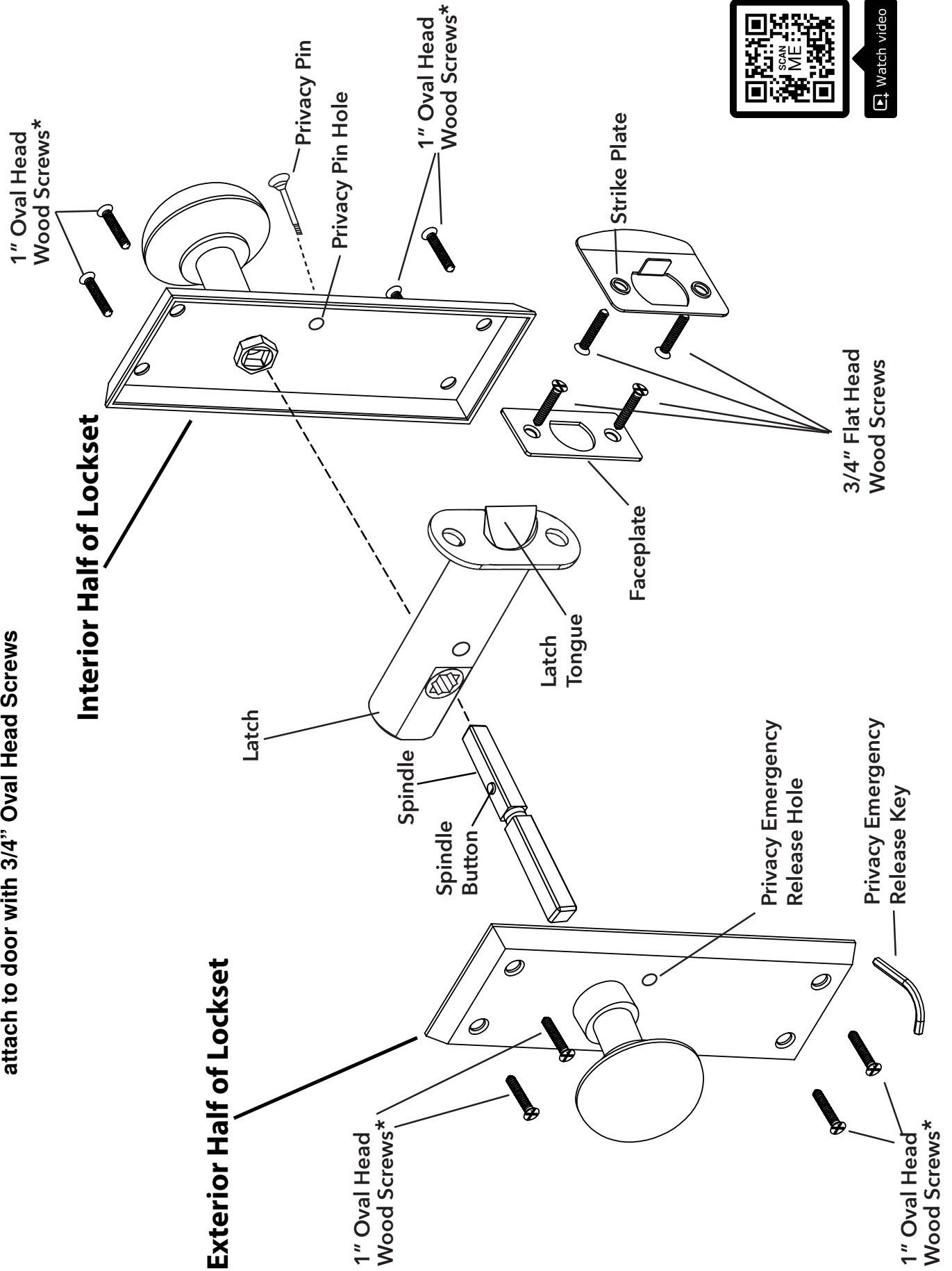

# Installation Instructions For Pre-Attached Long Plates

**Fits doors  
1-3/8" to 1-3/4" thick**

**Passage/Privacy**

**A**

## Backset Information

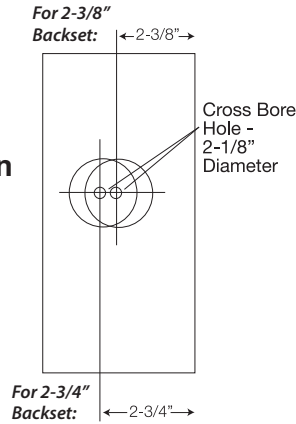

**NOTE:**  
DRILLING  
TEMPLATES  
FOR  
PILOT HOLES  
ON SEPARATE  
INCLUDED  
SHEET

**B**

## Install Latch

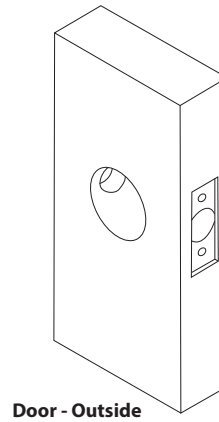

- 1 Install latch and rotate the latch tongue \* to change handing. (See page 1 for handing)
- 2 Install faceplate with 3/4" wood screws.

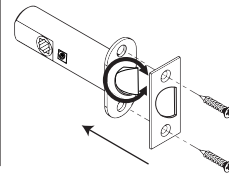

\* See Latch Tongue Note in next panel

**\***

## Latch Tongue Note

Bevel side of latch tongue should contact curved end of face plate, and curved end of strike plate.

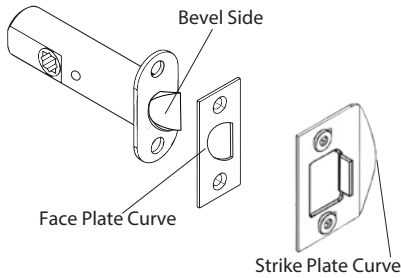

**C**

## Insert Spindle

- 1 Push spindle button down and hold during insertion

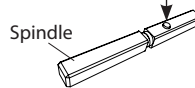

- 2 Insert

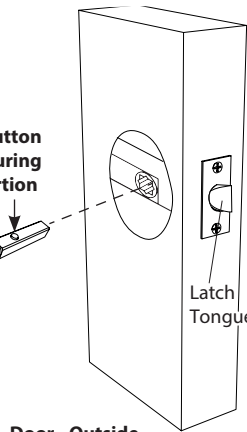

**D**

## Install Exterior Half of Lockset

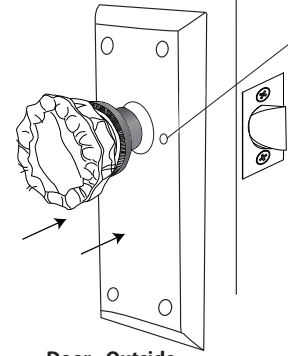

**E**

## Insert Wood Screws

**NO POWER TOOLS!!!**

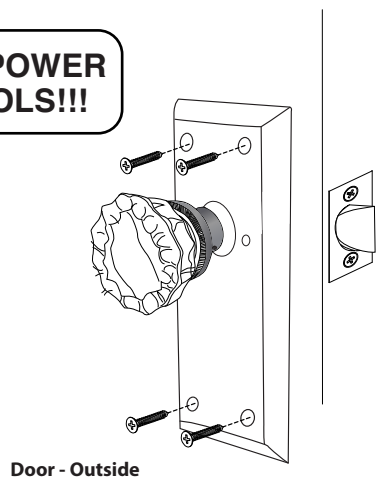

**F**

## Install Interior Half of Lockset

- 1 Insert wood screws

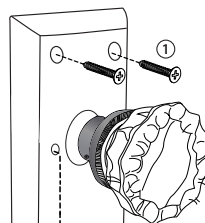

- 2 Screw in privacy pin (Privacy only)

Door - Inside

**G**

## Attach Strike Plate

Attach the strike plate to the door jamb using 3/4" long wood screws.

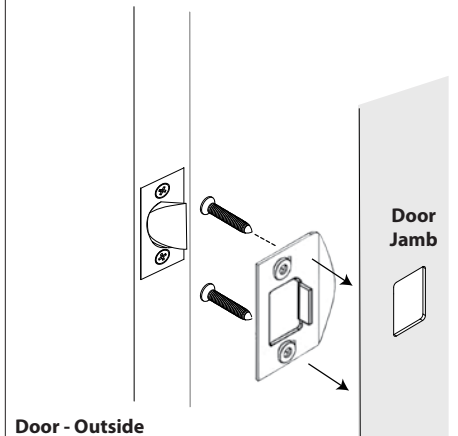

# DUMMY INSTALLATION AND DOOR PREPARATION TEMPLATE

(2) FOLD TEMPLATE ALONG DOTTED LINE, AND POSITION FOLD ON THE EDGE OF THE DOOR. TAPE TEMPLATE TO FACE OF DOOR.

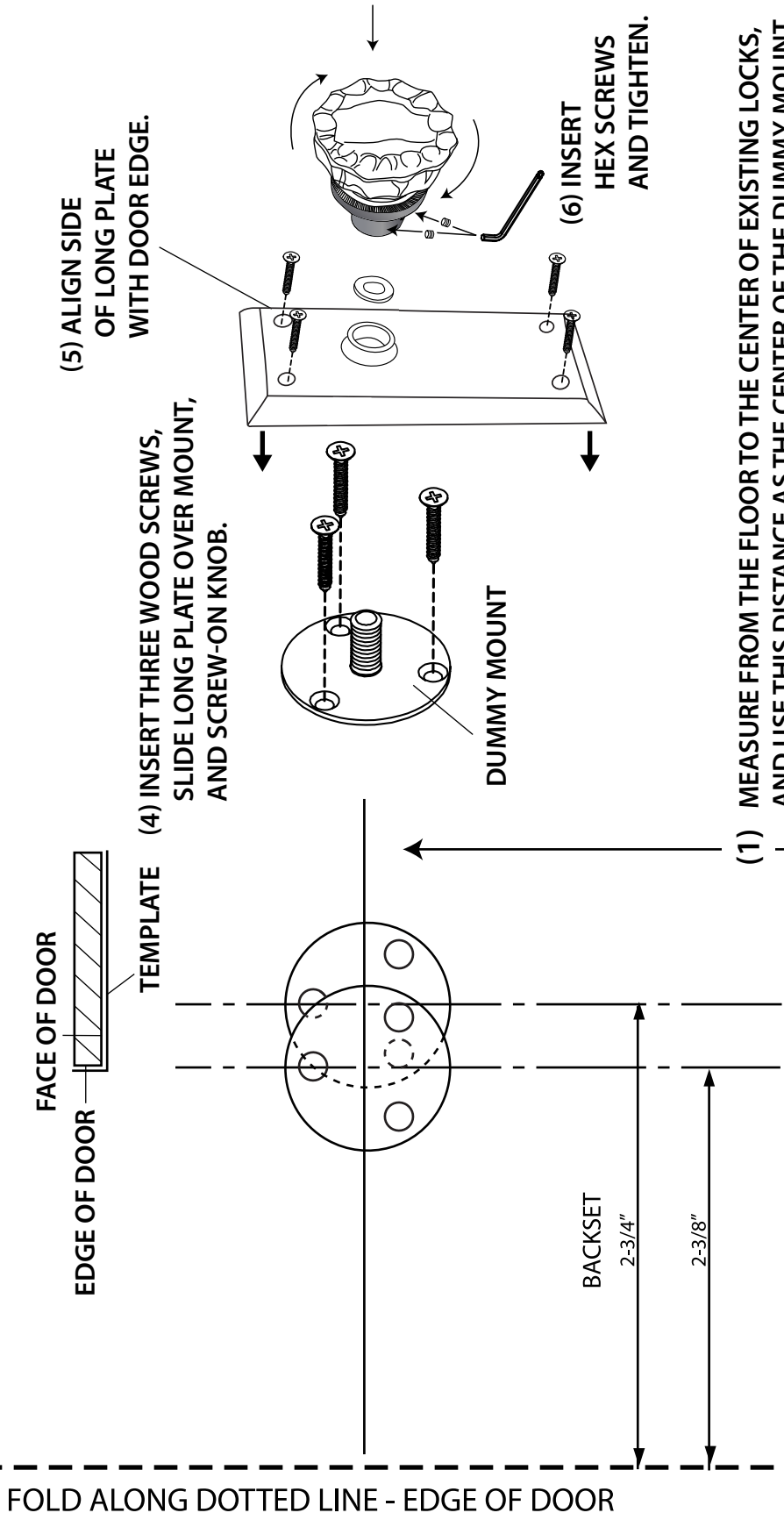

(5) ALIGN SIDE OF LONG PLATE WITH DOOR EDGE.

(4) INSERT THREE WOOD SCREWS, SLIDE LONG PLATE OVER MOUNT, AND SCREW-ON KNOB.

DUMMY MOUNT

(6) INSERT HEX SCREWS AND TIGHTEN.

(1) MEASURE FROM THE FLOOR TO THE CENTER OF EXISTING LOCKS, AND USE THIS DISTANCE AS THE CENTER OF THE DUMMY MOUNT. IF THERE ARE NO EXISTING LOCKS, POSITION THE DUMMY MOUNT 36" TO 38" FROM THE FLOOR.

(3) BEFORE DRILLING VERIFY THE BACKSET OF YOUR EXISTING DOORS IN YOUR HOUSE. DRILL PILOT HOLES USING A 7/64" DIAMETER BIT.