



TANKLESS GAS WATER HEATER

Owner's Guide

Model NC199-DVC

FOR USE IN RESIDENTIAL, COMMERCIAL, OR MANUFACTURED HOME APPLICATIONS.



WARNING

If the information in this manual is not followed exactly, a fire or explosion may result causing property damage, personal injury, or death.

- Do not store or use gasoline or other flammable vapors and liquids in the vicinity of this or any other appliance.
- WHAT TO DO IF YOU SMELL GAS
 - Do not try to light any appliance.
 - Do not touch any electrical switch; do not use any phone in your building.
 - Immediately call your gas supplier from a neighbor's phone. Follow the gas supplier's instructions.
 - If you cannot reach your gas supplier, call the fire department.
- Installation and service must be performed by a qualified installer, service agency or the gas supplier.



Low NOx
Approved by
SCAQMD



Accepted For Use
City of New York
Department of Buildings
MEA 19-03-E

Thank you for purchasing this Noritz Tankless Gas Water Heater. Before using, please:

Read this manual completely for operation instructions.

Completely fill out the warranty registration card (included separately) and mail the detachable portion to Noritz America Corporation.

Keep this manual (and the remainder of the warranty registration card) where it can be found whenever necessary.

Installation must conform with local codes, or in the absence of local codes, the National Fuel Gas Code, ANSI Z223.1/NFPA 54.

When applicable, installation must conform with the Manufactured Home Construction and Safety Standard, Title 24 CFR, Part 3280 or the Canadian Standard CAN/CSA-Z240 MH Mobile Homes, Series M86.

Noritz America reserves the right to discontinue, or change at any time, the designs and/or specifications of its products without notice.

NORITZ America Corporation

SBA8359
Rev. 09/09



SBA8359



Important Safety Information-1

To prevent damage to property and injury to the user, the icons shown below will be used to warn of varying levels of danger.

Every indication is critical to the safe operation of the water heater and must be understood and observed. Potential dangers from accidents during installation and use are divided into the following four categories. Closely observe these warnings; they are critical to your safety.

■ Icons warning of risk level

 This is the safety alert symbol. It is used to alert you to potential personal injury hazards. Obey all safety messages that follow this symbol to avoid possible injury or death.

	DANGER	DANGER indicates an imminently hazardous situation which, if not avoided, will result in death or serious injury.
	WARNING	WARNING indicates a potentially hazardous situation which, if not avoided, could result in death or serious injury.
	CAUTION	CAUTION indicates a potentially hazardous situation which, if not avoided, may result in minor or moderate injury.
CAUTION		CAUTION used without the safety alert symbol indicates a potentially hazardous situation which, if not avoided, may result in property damage.

■ Other icons

 Electric Shock.	 High Temperature.	 Be sure to do.	 Ground.	
 Prohibited	 No flame.	 Don't touch.	 Don't disassemble the equipment.	 Don't touch with a wet hand.

 **DANGER**



Prohibited

Vapors from flammable liquids will explode and catch fire causing death or severe burns.

Do not use or store flammable products such as gasoline, solvents or adhesives in the same room or area near the water heater.

Keep flammable products:

1. Far away from the water heater.
2. In approved containers.
3. Tightly closed.
4. Out of children's reach.

Vapors:

1. Cannot be seen.
2. Vapors are heavier than air.
3. Go a long way on the floor.
4. Can be carried from other rooms to the main burner by air currents.



Flammable Vapors



Prohibited

Hot Water Heater temperatures over 125 °F can cause severe burns instantly or death from scalding.

Children, disabled and elderly are at the highest risk of being scalded. Feel water temperature before bathing or showering. Temperature limiting valves are available, ask professional person.

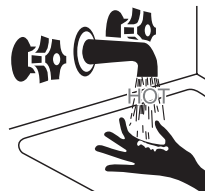

(Continued)



Prohibited

Do not use the water heater if the concentric pipe is displaced, has holes, is clogged or is corroded.

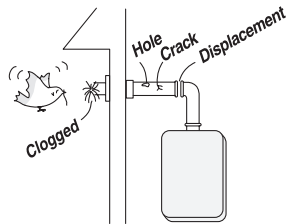

Prohibited

Do not allow anyone to change the water temperature while hot water is being used.

To prevent scalding, do not change the water temperature to a higher setting.

WARNING



No flame.

A. This water heater does not have a pilot. It is equipped with an ignition device that automatically lights the burner. Do not try to light the burner by hand.

B. BEFORE OPERATING smell all around the water heater area for evidence of leaking gas. Be sure to smell next to the floor because some gas is heavier than air and will settle on the floor.

WHAT TO DO IF YOU SMELL GAS.

- Do not try to light any appliance.
- Do not touch any electrical switch; do not use any phone in your building.
- Immediately call your gas supplier from a neighbor's phone. Follow the gas supplier's instructions.
- If you cannot reach your gas supplier, call the fire department.

C. Use only your hand to turn the gas valve knob. Never use tools. If the knob will not turn by hand, don't try to repair it. Call a qualified service technician. Force or attempted repair may result in a fire or explosion.

D. Do not use this water heater if any part has been under water. Immediately call a qualified service technician to inspect the water heater and to replace any damaged parts.



Be sure to do.

When a gas leak is noticed:

1. Stop use immediately
2. Close the gas valve
3. Open windows and doors



Be sure to do.

If you detect abnormal combustion or abnormal odors, or during an earthquake, tornado or fire:

1. Turn off the hot water supply
2. Turn off the power to the water heater
3. Turn off gas and water supply valve.
4. Call the nearest Noritz agent



Prohibited

Explosion Hazard ;

If the temperature and pressure relief valve is dripping or leaking, have a qualified service technician replace it. Do not plug or remove the valve.

Failure to follow these instructions can result in fire or explosion, and personal injury or death



High Temperature.

Check the temperature of the running hot water before entering the shower.



Check the temperature before stepping into the bath tub.



(Continued)

Important Safety Information-2

(Continued)

⚠ WARNING



Do not place the flue terminal in an indoor environment by means of adding walls and ceiling (Do not enclose using corrugated sheets, etc.)

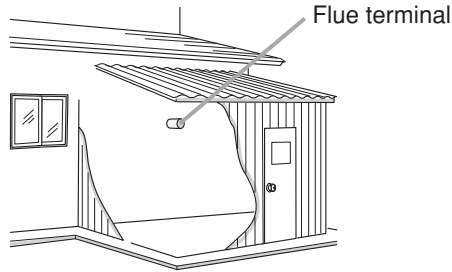

Carbon monoxide poisoning or fire may occur as a result.



Carbon Monoxide Poisoning Hazard. Do not install this water heater in a recreational vehicle or on a boat.



Do not use combustible chemicals such as oil, gasoline, benzene etc. in the near the heater or the flue terminal.



Do not store or use gasoline or other flammable vapors and liquids in the vicinity of this or any other appliance.



Do not place or use a spray can near the heater or the flue terminal.



Do not place outdoors

Rain may enter the unit or the burner fire may be blown by the wind, causing malfunction or fire as a result.



Be sure the gas/power supplied matches the gas on the rating plate.

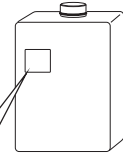

For Natural Gas

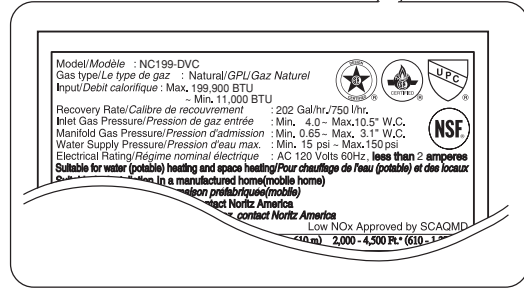

Leave the proper clearance between the water heater and nearby objects (trees, timber, boxes with flammable materials etc.).

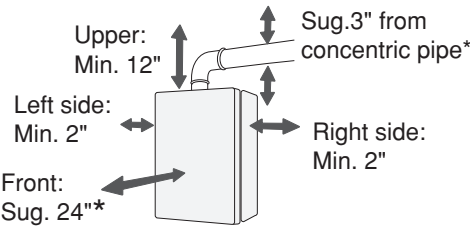

* Indicates suggested clearances for maintenance.



Installation and service must be performed by a qualified installer, service agency or the gas supplier.



Do not place combustibles such as laundry, newspapers, oils etc. near the heater or the flue terminal.

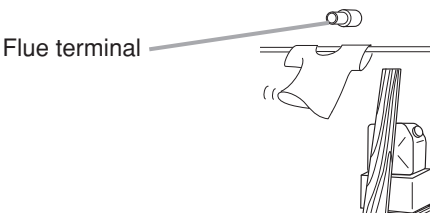

If this unit will be installed in a beauty salon or other location where hair spray or aerosols will be used, locate the unit in a separate area that is supplied with fresh air from outdoors.



Do not use hair spray or spray detergent in the vicinity of the heater.

(Continued)



Prohibited

Do not allow small children to play unsupervised in the bathroom. Do not allow small children to bathe unsupervised.



Don't touch with a wet hand.



Electric Shock.

Do not touch the power cord with wet hands.



Be sure to do.

Consult the nearest Noritz agent if the water heater location needs to be changed.



Don't disassemble the equipment.

Contact a qualified service technician for any necessary repairs, service or maintenance.



Be sure to do.

Contact Noritz before using with a solar pre-heater.

California Proposition 65 lists chemical substances known to the state to cause cancer, birth defects, death, serious illness or other reproductive harm. This product may contain such substances, be their origin from fuel combustion (gas, oil) or components of the product itself.

The gas conversion kit shall be installed by a qualified service agency in accordance with the manufacturer's instructions and all applicable codes and requirements of the authority having jurisdiction. The information in the instructions must be followed to minimize the risk of fire or explosion or to prevent property damage, personal injury, or death. The qualified service agency is responsible for the proper installation of this kit. The installation is not proper and complete until the operation of the converted appliance is checked as specified in the manufacturer's instructions supplied with the kit.



CAUTION



Ground.

Be sure to electrically ground the unit.



Be sure to do.

Keep power cord free of dust.



Prohibited

Do not use the water heater for other than hot water supply, shower and bath.



Prohibited

Do not use a broken or modified power cord. Do not bind, bend or stretch power cords. Do not scratch, modify, or subject them to impact or force.



Be sure to do.

To prevent burns or scalding, turn off the power button and wait until the equipment cools before performing maintenance.



Prohibited

Do not turn off the water heater while someone is bathing.



Prohibited

Do not cover the water heater and the flue terminal, store trash or debris near it, or in any way block the flow of fresh air to the unit.



Prohibited

Do not install in locations where excessive dust or debris will be in the air.



Don't touch.

Do not touch the flue terminal and concentric pipe during or immediately after operation of the water heater.



Important Safety Information-3

CAUTION

Do not drink water that has been inside the unit for an extended period of time. Do not drink the first use of hot water from the unit in the morning.

Clean the filter on the water inlet as frequently as required by the quality of your local water.

Keep the area around the unit clean.

If boxes, weeds, cobwebs, cockroaches etc. are in the vicinity of the unit, damage or fire can result.

Do not install the equipment where the exhaust will blow on walls or windows.

If the water supply is in excess of 12 grains per gallon (200 mg/L) of hardness, acidic or otherwise impure, treat the water with approved methods in order to ensure full warranty coverage.

Problems resulting from scale formation are not covered by the warranty.

Check ignition during use and extinction after use.

Do not run water through the unit when unit is not on.

When discharging hot water, make sure the unit is ON. If water is run through the unit with the unit OFF, water may condense inside the unit and cause incomplete combustion or damage to the internal electrical components.

For single-handle fixtures or valves, discharge water setting the handle completely to the water side.

This unit is only approved for installation up to 4500 ft. above sea level.

For installations at higher elevations, contact Noritz America for Instructions.

Do not disassemble the operation panel.

Do not use benzene, oil or fat detergents to clean the operation panel.

This may cause deformation.

Do not get the operation panel wet.

Although it is water resistant, too much water can cause damage.

Do not splash water on the operation panel. Do not expose the operation panel to steam.

Do not locate the operation panel near stoves or ovens, this may cause damage or failure.

Preventing damage from freezing (☞p.17)

Damage can occur from frozen water within the device and pipes even in warm environments. Be sure to read below for appropriate measures. Repairs for damage caused by freezing are not covered by the warranty.

Take necessary measures to prevent freezing of water and leakage of gas when leaving the unit unused for long periods of time. (☞p.18)

If it is snowing, check the flue terminal for blockage.

Do not use parts other than those specified for this equipment.



Contents

Important Safety Information	2
Contents	7
General Parts	
Main Unit.....	8
Operation Panel	9
Initial Operation	10
How to Use	
Muting the Operation Panel	11
Setting and Using the Water Heater	12
Flow Meter Alarm	14
Adjusting the Maximum Output Temperature	16
Preventing Damage from Freezing	17
Regular Maintenance	19
Troubleshooting	21
Follow-up Service	25
Specifications	27

General Parts

Main Unit

Indoor Wall Mounted, Power Vent/Sealed Model

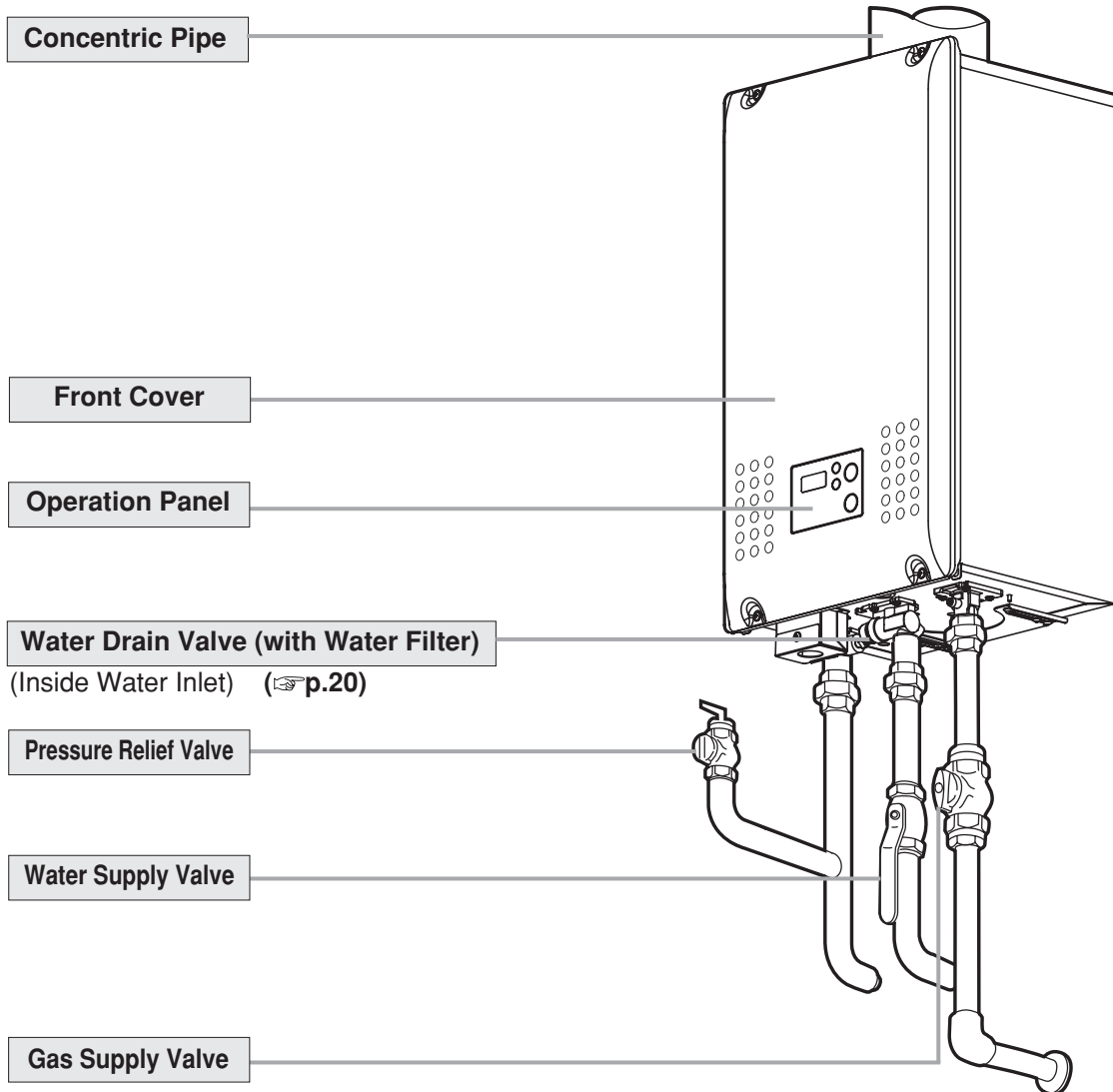

* The above illustration shows an example of installation.
The exact installation configuration may be slightly different.

Operation Panel (RC-7649M)

What is actually displayed depends on how the water heater is set.

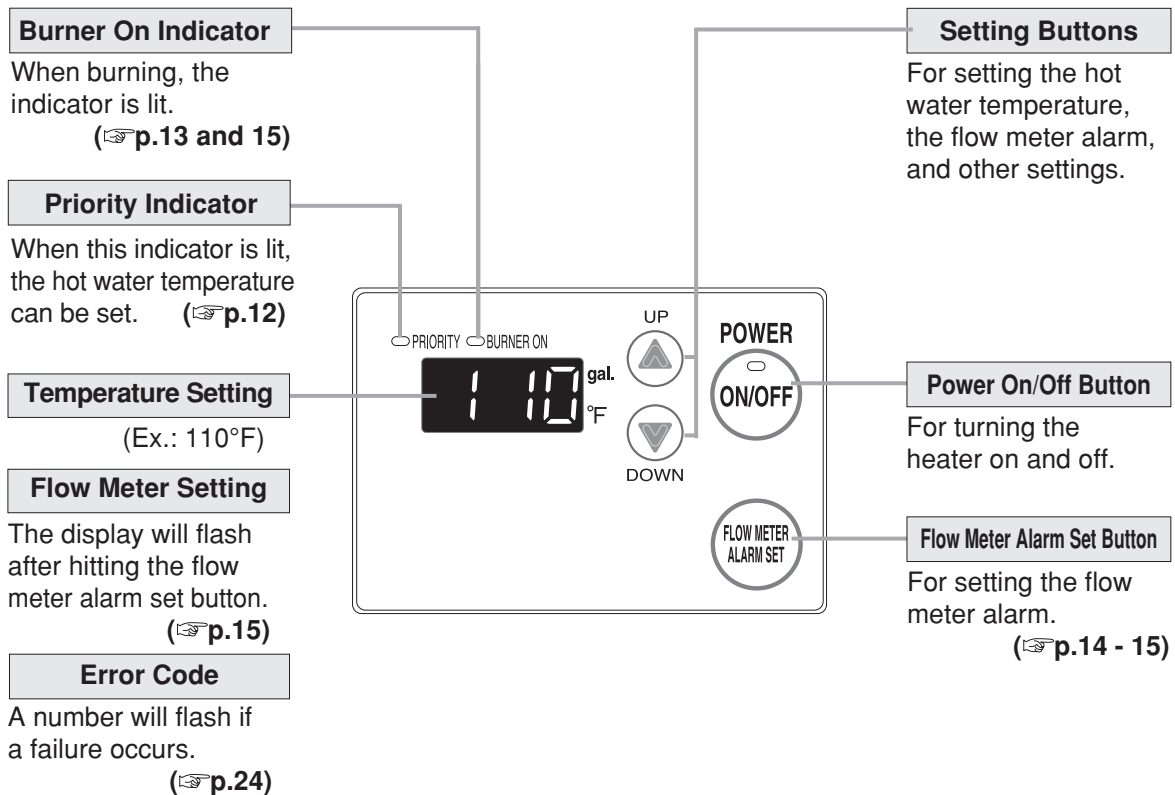

* Before use, remove the protective sheet from the operation panel surface.

Initial Operation

Before the first use of your water heater, make the following preparations.

Follow steps **1 through 4.**

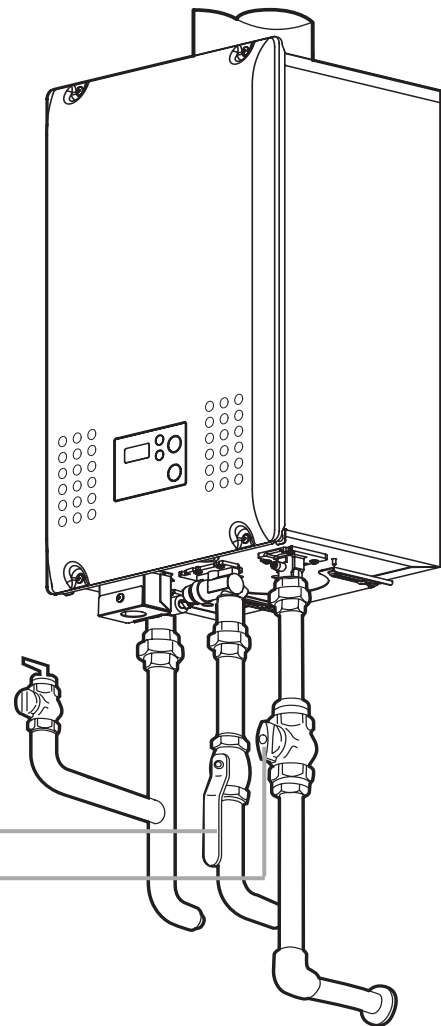
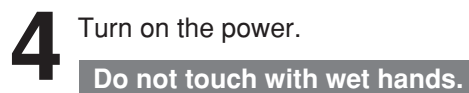
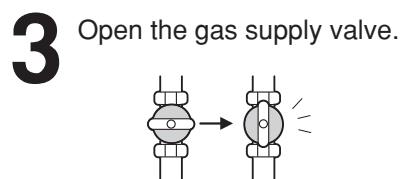
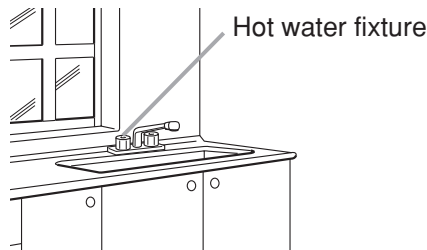
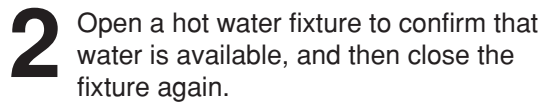
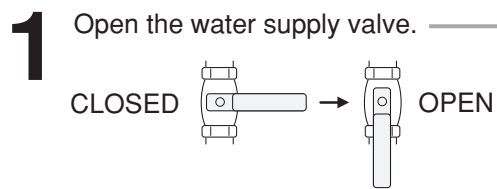

How to Use

Muting the Operation Panel

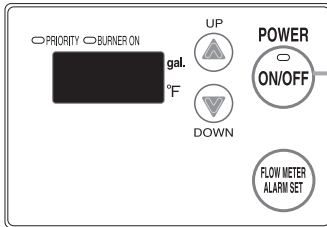

The operation panel will emit a sound when any button is pushed. This sound can be muted if it is desired.

* Initial factory setting is with sound

1 Hold the Power On/Off Button for five seconds.

Muted

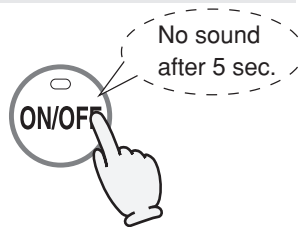

Sound

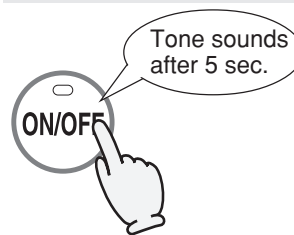

- The flow meter alarm cannot be muted.
- The high temperature warning tone when setting the unit to 125°F or higher will not emit a sound when muted.

How to Use

Setting and Using the Water Heater

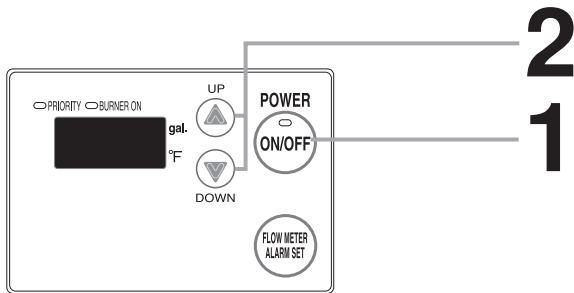

(Starting with the Power Off)

1 Press the Power On/Off Button.

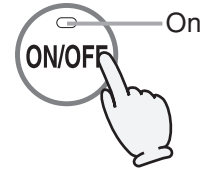

The temperature will be displayed on the operation panel thermostat.



Previous set temperature
(Ex.: 110°F)

DANGER

 To prevent scalding:
High Temperature

Hot Water Heater temperatures over 125°F can cause severe burns instantly or death from scalding.

- Children, disabled and elderly are at the highest risk of being scalded. Feel water temperature before bathing or showering. Temperature limiting valves are available, ask professional person.
- When setting the unit to 125°F or higher, the temperature display will flash for 10 seconds and emit a tone as a high temperature warning.
- Take caution when using the unit again after setting to 125°F or higher. Always check the set temperature before use.
- Do not allow anyone to change the water temperature while hot water is running.

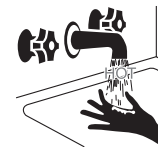

Operation Panel Display



Flashes for 10 sec



2 Set temperature. (Always check the temperature setting before use.)

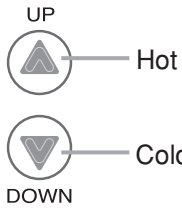

Check the indicator lights.



Water temperature



3 Turn on hot water.

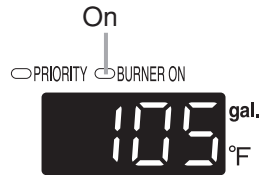

4 Turn off the hot water.



(°F: The temperature settings below are examples. The temperature setting necessary depends on the usage, the length of piping and the time of year.)

The maximum output temperature can be set using the operation panel. (p.16)

Contact the installer or Noritz America when setting the maximum output temperature in this range.

100	105	110	115	120	125	130	135	140	145	150	160	170	180
Washing dishes, etc.		Shower, hot water supply, etc.			High temperature								

If fixtures incorporate mixing valves, set the temperature higher than usual.

*Initial factory setting is 110°F

- * For most residential applications, the recommended setting temperature is 120°F or less.
- * Consult local codes for minimum operating temperatures.

How to Use

Flow Meter Alarm

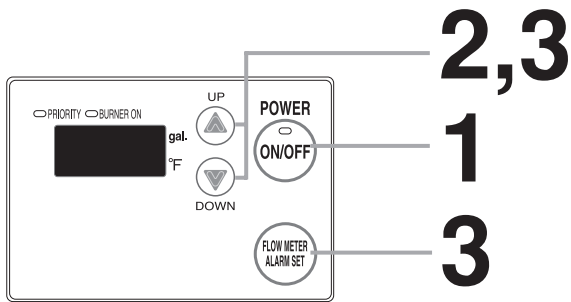

(Starting with the power off)

Preparation

Plug the bath drain.

1 Press the Power On/Off Button

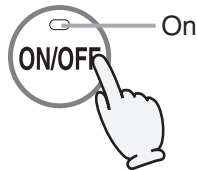

The temperature will be displayed on the operation panel thermostat.



Previous set temperature (example: 110°F)

2 Set temperature. (Always check temperature setting before use.)

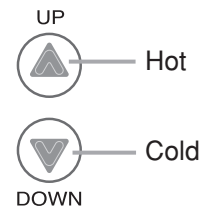

Check the indicator lights.



Water temperature

An alarm will sound for ten seconds when the flow reaches the set level.



The water will continue to run unless it is manually turned off.

Water Temperature

(°F: The temperatures settings below are only examples. The temperature setting necessary will depend on the usage, the length of piping and the time of year.)

100	105	110	115	120
Warm	Warmer		Hot	

* Initial factory setting: 110°F

To set the flow meter alarm:

3 Adjust flow meter alarm setting.

Press the flow meter alarm set button (the setting will flash on the display) and adjust with the setting buttons.

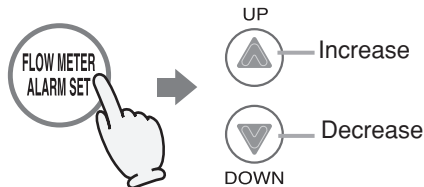

Choose the flow meter alarm setting from the following options: 10 - 60 (In 5 gallon intervals), 70 - 100 (In 10 gallon intervals), or 990 gallons.

Note: The alarm will not sound if it is set for 990 gal.



Flow meter setting will be flashing (ex. 45 gal.)

- * The level can only be adjusted while the indicator is flashing.
- * After ten seconds, the remote will again display the temperature.

4 Turn on hot water.

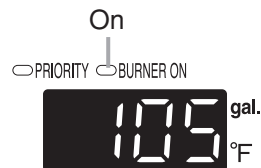

5 Turn off the hot water when the alarm sounds.

The alarm will sound when the set level has been reached. Stop the water.

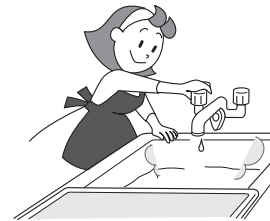

Note: The alarm will not sound if it is set for 990 gal.



If the flow meter alarm is being used to indicate when a tub is full:

- If any hot water is being used besides what is going into the tub, the alarm will sound before the tub is full.
- If there was water in the tub before the fill began, or if the water is not shut off manually when the alarm sounds, the tub may overflow.
- If there was water in the tub before the fill began, the temperature in the tub after it is full may be different from the temperature setting.

How to Use

Adjusting the Maximum Output Temperature

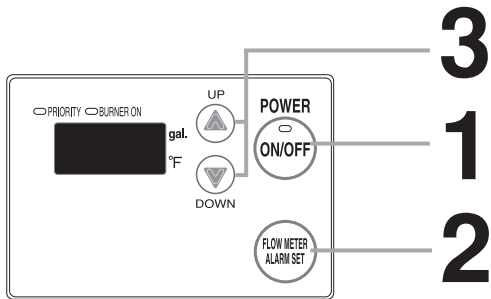

1 Turn off the power.

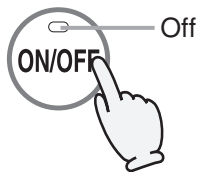

2 Press and hold the flow meter alarm set button until a sound is heard (2 sec.).

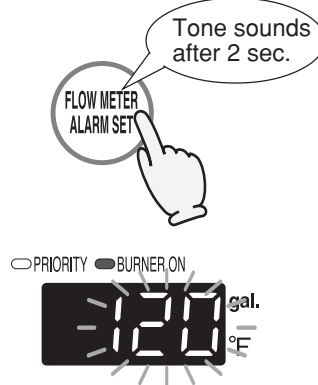

3 Change the temperature using the setting buttons.

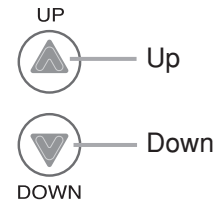

The upper limit of the hot-water supply temperature can be changed to 100°F, 105°F, 110°F, 115°F, 120°F, 125°F, 130°F, 135°F or 140°F.

4 Set the Power button to ON when continuing to use the unit as is. Otherwise, let the unit sit for 30 sec.

Preventing Damage from Freezing-1

CAUTION

- * Damage can occur from frozen water within the device and pipes even in warm environments. Be sure to read below for appropriate measures.
- * Repairs for damage caused by freezing are not covered by the warranty.

Freezing is prevented within the device automatically by the freeze-prevention heater

Freezing cannot be prevented when the power plug is unplugged. Do not remove the power plug from the wall outlet.

(Freezing will be prevented regardless of whether the operation switch is ON or OFF.)

- * In normal operation, freezing is prevented within the device automatically unless the outside temperature without wind is below -30°F .
- * The freeze prevention heaters will not prevent the plumbing external to the unit from freezing. Protect this plumbing with insulation, heat tape or electric heaters, solenoids, or pipe covers. If there remains a freezing risk, contact the nearest Noritz agent.

Take the measures below for extremely cold temperatures*.

(outside temperature including wind chill factor less than -30°F)

This method can protect not only the heater, but also the water supply, water piping and mixing valves.

1. Turn off the power.
2. Close the gas supply valve.
3. Open a hot water fixture, and keep a small stream of hot water running. (0.1 gal/minute or about 0.2" thick.)
 - * If there is a mixing valve, set it to the highest level.
 - * When linking multiple units, discharge water equivalent to 0.1 gal/minute per unit.
4. The flow may become unstable from time to time. Check the flow 30 minutes later.
 - * In general, it is not advisable to run water through the unit when it is OFF (p. 6), but in this case freeze prevention is more important.

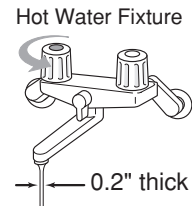

- * Remember to set mixing valves and fixtures to their original levels before using the unit again to prevent scalding.
- * If there is still a risk that the unit will freeze, drain the unit as shown on the next page.

If water will not flow because it is frozen

1. Close the gas and water valves.
2. Turn off the power button.
3. Open the water supply valve from time to time to check whether water is running.
4. When the water is flowing again, check for water leaks from the equipment and piping before using.

If the heater or the piping is frozen, do not use the heater or it may get damaged.

Preventing Damage from Freezing-2

If the water heater will not be used for a long period of time,
Drain the water.

Drain the water as follows:



To avoid burns, wait until the equipment cools down before draining the water.
The appliance will remain hot after it is turned off.

Drain water into a bucket to prevent water damage.

1. Close the gas valve.

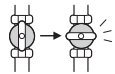

2. (1) Turn the power on.

- (2) Turn and leave open the hot water fixtures for more than 2 minutes and close.

* If multiple units are being used, drain two minutes for each unit.



* An 11 Error Code may appear on the operation panel.

This is not a malfunction of the unit. Do not turn Power ON/OFF Button OFF.

3. Close the water supply valve, disconnect the electrical power supplied to the unit.

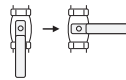

Do not touch with wet hands.

4. Fully open all hot water fixtures.

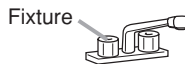

5. Open all drain plugs and drain the water out of the unit.

6. When the water is completely drained, replace all drain plugs and close the hot water fixtures.

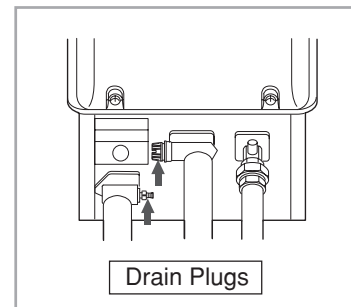

Turning the Unit Back On

1. Check that all drain plugs are inserted.
2. Check that all hot water fixtures are closed.
3. Follow the procedure on p.10 "Initial operation", steps 1 through 4.

Regular Maintenance-1

Periodic Inspection

CAUTION



Be sure to do.

To prevent burns or scalding, turn off the power button and wait until the equipment cools before performing maintenance.

Check

For laundry, newspaper, timber, oil, spray cans and other combustible materials.

Check

For dust and soot in the flue terminal.

Check

For abnormal sounds during operation.

Check

For abnormalities in external appearance, discoloration or flaws.

Check

For proper operation of pressure relief valve.

Check

For water leaks from the equipment and piping.

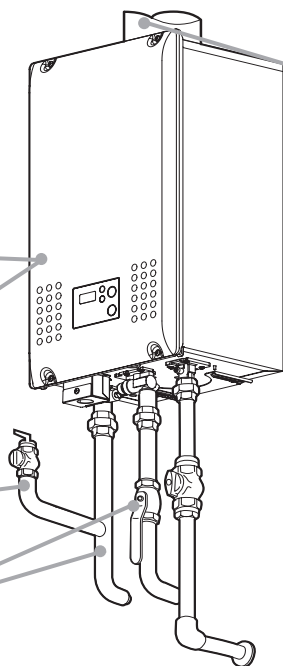

Periodic Maintenance

Equipment

Wipe the outside surface with a wet cloth, then dry the surface. Use a neutral detergent to clean any stains.

Operation Panel

Wipe the surface with a wet cloth.

- Do not use benzene, oil or fatty detergents to clean the operation panel; deformation may occur.
- The operation panel is water resistant but not water proof. Keep it as dry as possible.

Regular Maintenance-2

Periodic Maintenance

Water Drain Valve (with Water Filter)

If the water drain valve (with water filter) is covered with debris, the hot water may not run smoothly, or the unit may put out cold water. Check and clean the filter as explained below.

* **To avoid burns, wait until the equipment cools down before draining the water.**
The appliance will remain hot after it is turned off.

1. Close the water supply valve.
2. Open all hot water fixtures.
3. With a bucket ready, remove the inlet and outlet drain plugs (about 0.2 gal. will drain out)
4. Take the water drain valve (with water filter) out of the inlet. (See illustration to right).
5. Clean the water drain valve (with water filter) with a brush under running water.
6. Replace the water drain valve (with water filter) and close the drain plugs.
(Take care not to lose the packing.)
7. Close all hot water fixtures.
8. Open the water supply valve and check that water does not leak from the drain plugs or water drain valve (with water filter).

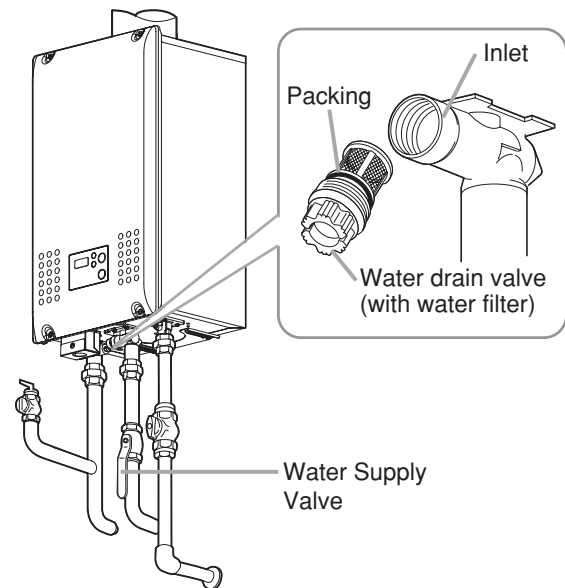

Optional Maintenance

Isolation Valves

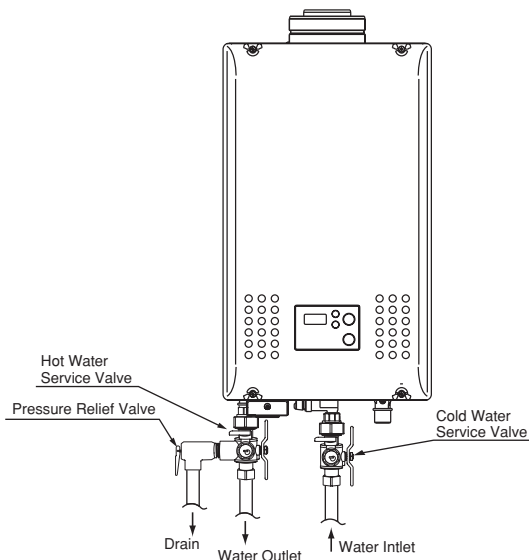

* Isolation valves may be purchased as an accessory from Noritz. They allow for full diagnostic testing and easy flushing of the system.

* The kit includes two full port isolation valves and a pressure relief valve for the hot side. Contact Noritz for more information.

Troubleshooting-1

Initial Operation

Unit does not attempt to ignite when water is running.	<ul style="list-style-type: none"> • Check for reversed plumbing or crossed pipes. • Check the water drain valve filter. (☞p.20)
Unit attempts to ignite but fails	<ul style="list-style-type: none"> • Reset unit and try again. There may be air in the gas line. • Have a professional check the gas supply pressure.

Temperature

Hot water is not available when a fixture is opened.	<ul style="list-style-type: none"> • Are the gas and water supply valves fully open? • Is the water supply cut off? • Is the hot water fixture sufficiently open? • Is the gas being cut off by the gas meter? (Can other gas devices such as stoves be used?) • (For LP) Is there enough gas in the tank? (Can other gas devices such as stoves be used?) • Is the water drain valve filter clogged? (☞p.20) • Is the power button turned on?
No water is available when a fixture is opened.	<ul style="list-style-type: none"> • Is the water supply cut off? • Is the heater frozen?
The hot water is not the correct temperature.	<ul style="list-style-type: none"> • Is the hot water fixture sufficiently open?
Water takes time to become hot when turning the hot water fixture.	<ul style="list-style-type: none"> • Have you allowed enough time for the cold water in the pipes to drain out?
The water is too hot.	<ul style="list-style-type: none"> • Are the gas and water supply valves fully open? • Is the water temperature setting appropriate? (☞p.12 and p.13) • If the water supply temperature is high, it is possible for the temperature to be higher than the temperature set on the operation panel. • If only a small amount of hot water is demanded, it is possible for the temperature to be higher than the temperature set on the operation panel.
The water is not hot enough.	<ul style="list-style-type: none"> • Are the gas and water supply valves fully open? • Is the water temperature setting appropriate? (☞p.12 and p.13) • If the amount of hot water required is very high, it is possible for the temperature to be lower than the temperature set on the operation panel. Decrease the amount of hot water passing through the unit and the temperature should stabilize.

(Continued)

Troubleshooting-2

(Continued)

<p>The water is cold when only a single fixture is open.</p>	<ul style="list-style-type: none"> • The unit will not heat the water if the flow rate is less than 0.5 gallons per minute. Open the fixture more or open other fixtures so that a greater flow passes through the unit, and the unit should begin heating again.
<p>Fluctuations in hot water temperatures.</p>	<ul style="list-style-type: none"> • Set water temperature at 115°F to 120°F. This will allow you to use a higher flow of hot water thus meeting the minimum flow requirement of 0.5 gpm. • Clean the water filter of any debris (☞p.20)
<p>Setting temperature cannot rise.</p>	<ul style="list-style-type: none"> • Is the maximum temperature setting appropriate? (☞p.16)

Amount of Hot Water

<p>The amount of hot water at a certain fixture is not constant.</p>	<ul style="list-style-type: none"> • When hot water is demanded at other fixtures, the amount available may be reduced. The maximum flow available from this unit is 7.5 GPM at a 45°F temperature rise. • Pressure fluctuations and other plumbing conditions can cause the temperature and pressure at a fixture to be unstable, but it should stabilize after a short time. • There are some types of hot water taps that discharges large volumes of hot water at first but stabilize after time. • To keep the temperature stable, the heater limits the amount of water that can flow through it to a small amount initially, but the amount increases over time.
<p>The amount of hot water in the tub is less/more than the set amount.</p>	<ul style="list-style-type: none"> • When hot water is used for other fixtures while filling the bath tub, the tub will not fill as much. • If there is water in the tub already, or when filling is stopped and restarted, the tub will fill more.
<p>The flow meter alarm does not sound even when filled to the set amount.</p>	<ul style="list-style-type: none"> • The flow meter alarm is set to sound when hot water is continuously discharged for the set volume of water. If mixing valves are used, or if cold water is mixed with hot water at the fixture, the tub will fill more than the setting of the flow meter alarm.
<p>Amount of hot water available has decreased over time.</p>	<ul style="list-style-type: none"> • Is the water filter clogged? (☞ p.20) • If the supply water is hard and has not been treated, scale can build-up in the water heater and decrease the maximum amount of hot water available. Scale can be removed from the water heater by flushing the unit periodically. To prevent scale from forming in the water heater, a water softener or scale inhibitor is recommended.

Operation Panel

The light on the power button does not come on.	<ul style="list-style-type: none"> • Has there been a power failure? • Is the power connected properly?
The water temperature changes after a power failure or when the power is disconnected.	<ul style="list-style-type: none"> • The temperature setting and the flow meter alarm setting may both need to be reset after a power outage.
The plastic on the surface or buttons of the operation panel has torn, peeled, or air bubbles inside.	<ul style="list-style-type: none"> • The surface of the operation panel is affixed with a protective sheet (to prevent surface scratching, etc.) at time of shipment. This sheet can be removed or left as it is. When leaving the protective sheet on, areas frequently touched may tear or peel. However, the operation panel will not malfunction from water entering such torn or peeled areas. To restore the appearance of the operation panel surface, simply remove the protective sheet.

Sounds

<p>The fan can be heard after operation is stopped.</p> <p>A motor can be heard when turning the unit ON or OFF, when opening or closing a fixture, or after the unit has been running for a while.</p>	<ul style="list-style-type: none"> • These noises indicate the proper operation of devices which are designed to let the unit reignite more quickly, and ensure the water temperature is stable.
---	---

Other

The Heater stops burning during operation.	<ul style="list-style-type: none"> • Are the gas and water supply valves fully open? • Is the water supply cut off? • Is the hot water fixture sufficiently open? • Is the gas being cut off by the gas meter? (Can other gas devices such as stoves be used?) • (For LP) Is there enough gas in the tank? (Can other gas devices such as stoves be used?)
White smoke comes out of the exhaust vent on a cold day.	<ul style="list-style-type: none"> • This is normal. The white smoke is actually steam.
The hot water is turbid.	<ul style="list-style-type: none"> • This is harmless. Small bubbles appear as the air in the water is heated and depressurized rapidly to atmospheric pressure.
The water appears blue The bath tub/wash-basin has turned blue	<ul style="list-style-type: none"> • Coloration to a blue color may be noticed from small traces of copper ion contained in the water and fat (furring). However, there are not problems concerning health. Coloration of the bath tub/wash-basin can be prevented by cleaning frequently.

Troubleshooting-3

Water Quality

Damage to the water heater as a result of poor water quality is not covered by the Limited Warranty. To ensure full warranty coverage, treat or condition water that exceeds the target levels provided in this table.

Source: EPA National Secondary Drinking Water Regulations (40 CFR Part 143.3)

Total Hardness*	: 200 mg/L (12 gpg) or less
Aluminum	: 0.05 to 0.2 mg/L or less
Chloride	: 250 mg/L or less
Copper	: 1 mg/L or less
Iron	: 0.3 mg/L or less
Manganese	: 0.05mg/L or less
pH	: 6.5 - 8.5
Total Dissolved Solids	: 500 mg/L or less
Zinc	: 5 mg/L or less
Sulfate ion	: 250 mg/L or less
Residual chlorine	: 4 mg/L or less

* Maximum limit suggested by Noritz.

Check for an Error Code on the Operation Panel

If there is a problem with the unit, a numerical error code will flash on the operation panel. If this occurs, take appropriate measures as listed below.

When an error code appears, the display and the operation light will flash together.

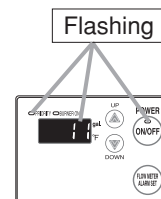

Error Code	Cause	Action
11	Ignition error	Check whether the gas valve is open. Press the power button to turn the unit off, open a hot water fixture, and turn the unit back on. If the flashing number doesn't return the problem is solved.
90	Abnormal combustion, low gas supply pressure	Have a professional check the gas supply pressure. Contact the nearest Noritz agent.
99	Abnormal combustion	Contact the nearest Noritz agent.

Contact Noritz America if:

- Any other error code appears.
- An error code is indicated again after the above actions were followed.
- There are any other questions.

Follow-up Service-2

Gas Conversion

If you move to a region that uses a different type of gas or if the local gas supply is converted, replacement of the gas manifold and adjustment of the appliance will be necessary. This work must be performed by either Noritz or a qualified service agency and will be charged for even during the warranty period. The qualified installer will also be responsible for purchasing the gas conversion kit directly from the manufacturer.

For more information, contact Noritz America Technical Support at 866-766-7489.

WARNING

The gas conversion kit shall be installed by a qualified service agency* in accordance with the manufacturer's instructions and all applicable codes and requirements of the authority having jurisdiction. The information in the instructions must be followed to minimize the risk of fire or explosion or to prevent property damage, personal injury, or death. The qualified service agency is responsible for the proper installation of this kit. The installation is not proper and complete until the operation of the converted appliance is checked as specified in the manufacturer's instructions supplied with the kit.

* A qualified service agency is any individual, firm, corporation, or company which either in person or through a representative is engaged in and is responsible for the connection, utilization, repair or servicing of gas utilization equipment or accessories; who is experienced in such work, familiar with all precautions required, and has complied with all of the requirements of the authority having jurisdiction.

Before the gas conversion is performed, verify the proper gas conversion kit with your water heater model on the table provided below.

Conversion Kit	Conversion Type
CK-17	Propane to Natural Gas
CK-18	Natural Gas to Propane

The following parts are supplied in the conversion kit. These items will replace the existing parts that are currently installed in the unit. Make sure that all parts are replaced and properly installed by a qualified service agency.

* A Noritz remote controller and a digital gas manometer are required to complete the installation. Do not proceed if this equipment is not immediately available.

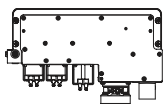

Manifold Plate



O-Ring

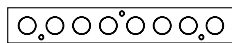

Damper



Conversion Kit Label



Exhaust Ring

After the necessary parts have been replaced on the unit, the remote controller is then used to adjust the settings on the water heater for use with the proper gas type.

The gas pressure values at both the gas supply inlet fitting and at the manifold inlet on the unit are verified by the installer. Proper adjustments will be made to ensure safe and efficient operation.

Once this is completed, a final gas leak check will be performed to confirm that all parts have been securely installed.

If you notice the smell of gas at any time after the installation has been completed, turn the water heater off and contact your gas supplier immediately.

Specifications

- Specifications may be changed without prior notice.
- The capacity may differ slightly, depending on the water pressure, water supply, piping conditions, and water temperature.

Specifications

Item	Specification
Model Name	NC199-DVC
Type	Indoor, Wall Mounted
Installation	Power Vented
Air Supply/Exhaust	Direct Ignition
Ignition	Direct Ignition
Operating Pressure	15-150 psi
Minimum Flow Rate	0.5 GPM
Dimensions	23.6"(Height) x 13.8"(Width) x 10.2"(Depth)
Weight	55 lbs.
Water Holding Capacity	0.2 Gallon
Connection Sizes	Water Inlet
	Hot Water Outlet
	Gas Inlet
Power Supply	Supply
	Consumption
Materials	Casing
	Flue Collar
	Heat Exchanger
Safety Devices	Flame Rod, Thermal Fuse, Lightning Protection Device (ZNR), Electric Leakage Prevention Device (GFCI), Overheat Prevention Device, Freezing Prevention Device, Fan Rotation Detector
Accessories	Anchoring Screws

Performance

Item	Maximum Performance	Minimum Performance
Gas Consumption	199,900 btuh	11,000 btuh
	199,900 btuh	11,000 btuh
Maximum Hot Water Capacity	7.5 Gal./min.	
Capacity Range	0.5-9.8 Gal./min.	
Temperature Settings	100-150°F (In 5°F intervals), 160, 170, 180°F (In 10°F intervals) (14 Options)	
Default Temperature Options	120,130,140,180°F (Original is 120°F)	

