

Installation Manual

NORITZ AMERICA
CORPORATION

TANKLESS GAS WATER HEATER

NC1990D (GQ-2857WZ US) (Outdoor Installation)

Potential dangers from accidents during installation and use are divided into the following three categories. Closely observe these warnings, they are critical to your safety.



DANGER

DANGER indicates an imminently hazardous situation which, if not avoided, will result in death or serious injury.



WARNING

WARNING indicates a potentially hazardous situation which, if not avoided, could result in death or serious injury.



CAUTION

CAUTION indicates a potentially hazardous situation which, if not avoided, may result in minor or moderate injury.

WARNING: If the information in this manual is not followed exactly, a fire or explosion may result causing property damage, personal injury or death.



Prohibited



Disconnect
Power



Ground



Be sure to do



CAUTION

Requests to Installers

- In order to use the water heater safely, read this installation manual carefully, and follow the installation instructions.
- Failures and damage caused by erroneous work or work not as instructed in this manual are not covered by the warranty.
- Check that the installation was done properly in accordance with this Installation Manual upon completion.
- After completing installation, please either place this Installation Manual in a plastic pouch and attach it to the side of the water heater (or the inside of the pipe cover or recess box if applicable), or hand it to the customer to retain for future reference. Also, be sure to fill in all of the required items on the warranty and to hand the warranty to the customer along with the Owner's Guide.



Low NOx
Approved by
SCAQMD
14 ng/J or 20 ppm
(Natural Gas Only)



FOR USE IN RESIDENTIAL OR MANUFACTURED HOME APPLICATIONS.

Installation must conform with local codes, or in the absence of local codes, the National Fuel Gas Code, ANSI Z223.1/NFPA 54-latest edition and/or the Natural Gas and Propane Installation Code CSA B149.1 - latest edition.

When applicable, installation must conform with the Manufactured Home Construction and Safety Standard, Title 24 CFR, Part 3280 or the Canadian Standard CAN/CSA-Z240 MH Mobile Homes, Series M86.

Noritz America reserves the right to discontinue, or change at any time, the designs and/or specifications of its products without notice.



SBB80J8-1
Rev. 05/16



SBB80J8

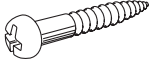
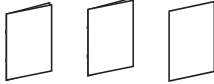
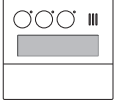

1. Included Accessories

The following accessories are included with the unit. Check for any missing items before starting installation.

Part	Shape	Q'ty	Part	Shape	Q'ty
Anchoring Screw		5	Owner's Guide, Warranty, Installation Manual (this document)		1 each
Remote Controller (See p. 23)		1	Remote Controller Cord (6ft (2m))		1

2. Optional Accessories

The accessories listed below are not included with the units, but may be necessary for installation.

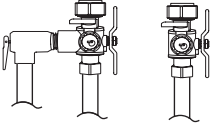
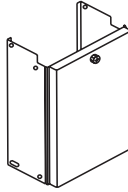
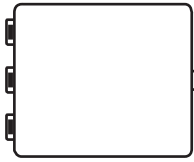
Part	Shape	Q'ty	Part	Shape	Q'ty
Remote Controller Cord (26ft (8m))		1	Quick Connect Cord (QC-2)		1
Isolation Valves* (includes pressure relief valve)		1 each	Pipe Cover (PC-2S-GRY)		1
System Controller (SC-301-6M-EXT)		1			

* Isolation valves are necessary for flushing the Heat Exchanger. They allow for easy flushing of the system.

3. Quick Connect Multi System Installation

- The Quick Connect Multi System allows the installation of two units together utilizing only the Quick Connect Cord.

The Quick Connect Cord is 6 ft.(2m) long. Install the units 2-18" (50 - 457mm) apart from each other to ensure the cord will be able to reach between the units. (See Typical Plumbing diagram). (If the distance between the two units is too great, not only will the cord not be able to reach, but the water temperature may also become unstable because of the difference in pipe length between the two units).

System Diagram

* When connecting two units, use only a single remote controller.

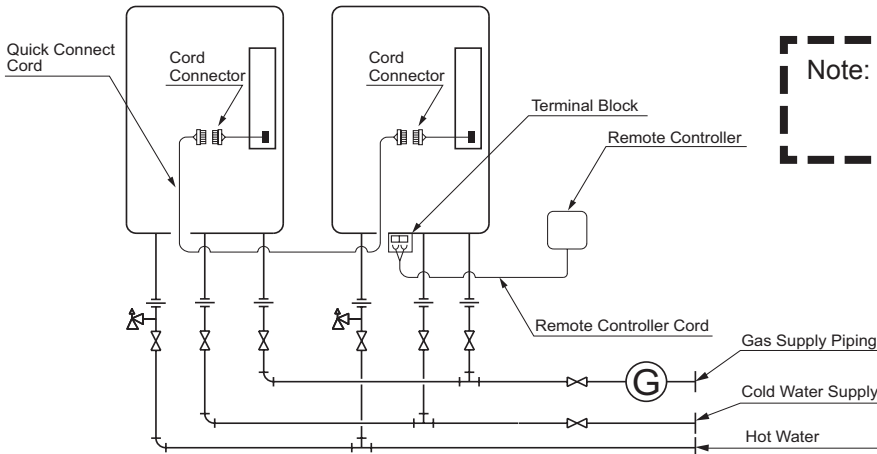

Note: Connect the remote controller to only one of the units.

Typical Plumbing

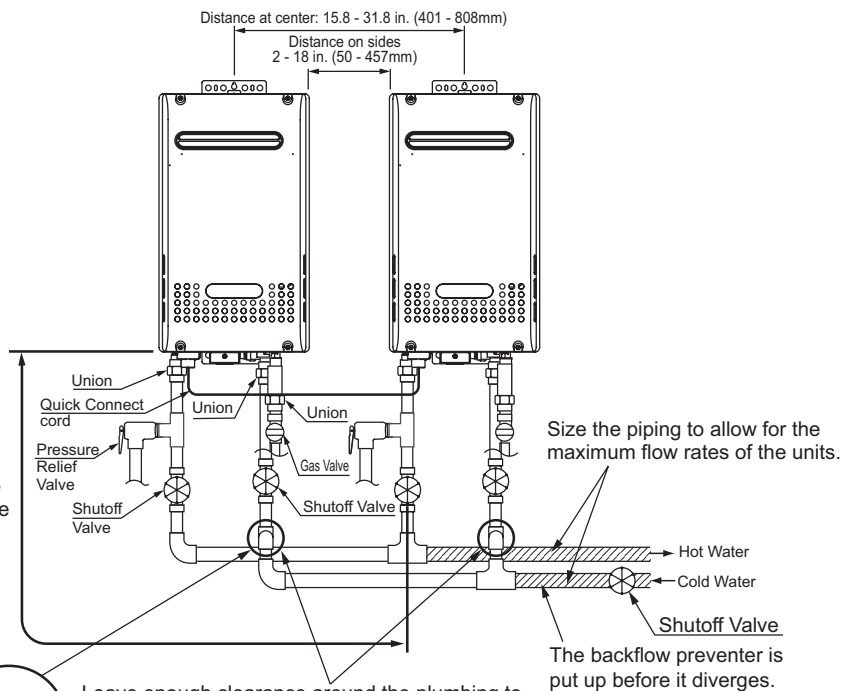

Make this distance as short as possible.
* The hot water temperature will become unstable as the pipe length increases.

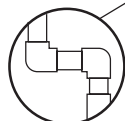

Leave enough clearance around the plumbing to apply insulation. It will be necessary to add bends to the piping to ensure that this clearance is available.

- Insulate the hot water piping to prevent heat loss. Insulate and apply heating materials to the cold water supply piping to prevent heat loss and freezing of pipes when exposed to excessively cold temperatures.

4. Before Installation

WARNING

Check the Gas

- Check that the rating plate indicates the correct type of gas.
- Check that the gas supply line is sized for 199,900 Btuh.

Check the Power

- The power supply required is 120VAC, at 60Hz. May result in fire or electric shock.

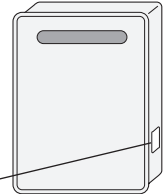
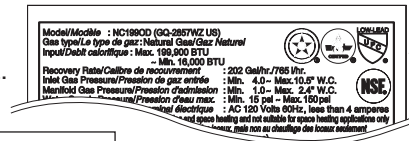

Use Extreme Caution if Using With a Solar Pre-Heater

- Using this unit with a solar pre-heater can lead to unpredictable output temperatures and possibly scalding. If absolutely necessary, use mixing valves to ensure output temperatures do not get to scalding levels. Do not use a solar pre-heater with the quick-connect multi-system.

Precautions for Mobile Home Installation

- Verify that the gas supply type matches the gas type listed on the rating plate. If a gas conversion must be done, follow the instructions listed in the manual.

CAUTION

Do Not Use Equipment for Purposes Other Than Those Specified

- Do not use for other than increasing the temperature of the water supply, as unexpected accidents may occur as a result.

Check Water Supply Quality

- If the water supply is in excess of 12 grains per gallon (200 mg/L) of hardness, acidic or otherwise impure, treat the water with approved methods in order to ensure full warranty coverage.

5. Choosing Installation Site

- * Locate the appliance in an area where leakage from the unit or connections will not result in damage to the area adjacent to the appliance or to the lower floors of the structure. When such installation locations cannot be avoided, a suitable drain pan, adequately drained, must be installed under the appliance. The pan must not restrict combustion air flow.
- * As with any water heating appliance, the potential for leakage at some time in the life of the product does exist. The manufacturer will not be responsible for any water damage that may occur.

DANGER

- This water heater is for outdoor installation only. Never install it indoors. Do not enclose the termination with corrugated metal or other materials.

This will cause carbon monoxide poisoning and a potential fire hazard.

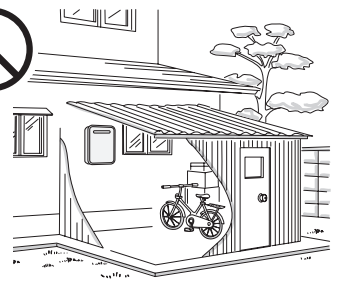
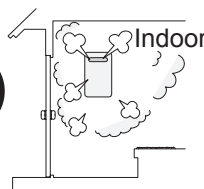

WARNING

- Avoid places where fires are common, such as those where gasoline, benzene and adhesives are handled, or places in which corrosive gases (ammonia, chlorine, sulfur, ethylene compounds, acids) are present.
Using the incorrect voltage may result in fire or cracking.
- Avoid installation in places where dust or debris will accumulate.
Dust may accumulate and reduce the performance of the unit's fan.
This can result in incomplete combustion.
- Avoid installation in places where special chemical agents (e.g., hair spray or spray detergent) are used.
Ignition failures and malfunction may occur as a result.
- Carbon Monoxide Poisoning Hazard. Do not install this water heater in a recreational vehicle or on a boat.

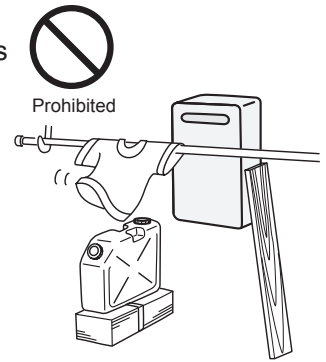

CAUTION

- Install the water heater in a location where it is free from obstacles and stagnant air.
- Consult with the customer concerning the location of installation.
- Do not install the water heater near staircases or emergency exits.
- Do not install the water heater where the exhaust will blow on outer walls or material not resistant to heat. Also consider the surrounding trees and animals.
The heat and moisture from the water heater may cause discoloration of walls and resinous materials, or corrosion of aluminum materials.
- Do not locate the vent termination directed towards a window or any other structure which has glass or wired glass facing the termination.
- Install in a location where the exhaust gas flow will not be affected by fans or range hoods.
- Take care that noise and exhaust gas will not affect neighbors.
Avoid installation on common walls as the unit will make some operational noises while it is running.
- Avoid installation where the unit will be exposed to excessive winds.
- Before installing, make sure that the vent termination will have the proper clearances according to the National Fuel Gas Code (ANSI Z223.1-latest edition) or the Natural Gas and Propane Installation Code (CSAB149.1).



State of California: The water heater must be braced, anchored or strapped to avoid moving during an earthquake. Contact local utilities for code requirements in your area or call: 1-866-766-7489 and request instructions.

The Commonwealth of Massachusetts:

- 1) The outdoor units (OD) can only be used if they are for summer use only.
- 2) The water heater can be used for hot water only and not in a combination of domestic and space heating.

6. Installation Clearances

WARNING

Before installing, check for the following:

Install in accordance with relevant building and mechanical codes, as well as any local, state or national regulations, or in the absence of local and state codes, to the National Fuel Gas Code ANSI Z223.1/NFPA 54 – latest edition. In Canada, see the Natural Gas and Propane Installation Code CSA B149.1 - latest edition for detailed requirements.

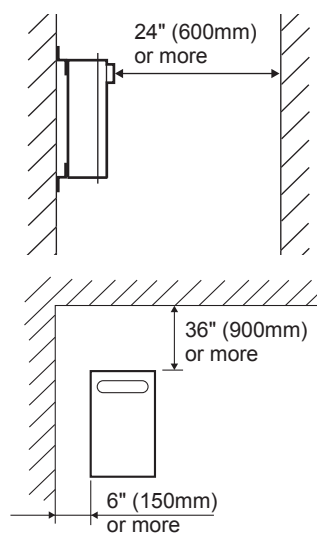
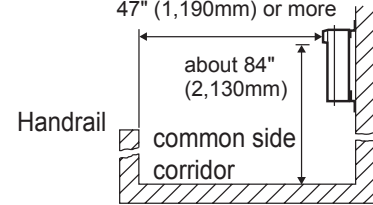
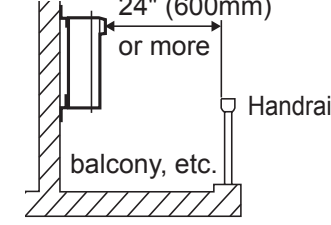
Item	Check	Illustration
Required Clearances From Heater	<ul style="list-style-type: none"> Maintain the following clearance from both combustible and non-combustible materials. 	
Surrounding the area of installation	<ul style="list-style-type: none"> When installing the unit in a common side corridor, provide a clearance of 47" (1,190mm) or more in front of the unit. Set the bottom edge of the exhaust port about 84" (2,130mm) from the corridor floor. 	
	<ul style="list-style-type: none"> When installing the unit on a balcony, etc., secure an evacuation route of 24" (600mm) or more in width. Provide clearance of 24" (600mm) or more in front of the unit to facilitate inspection and repair. Do not install the unit such as the wall of the second floor where the unit is out of reach. 	

Clearance Requirements from Vent Terminations to Building Openings

* All clearance requirements are in accordance with ANSI Z21.10.3 and the National Fuel Gas Code, ANSI Z223.1 and in Canada, in accordance with the Natural Gas and Propane Installation Code CSA B149.1.

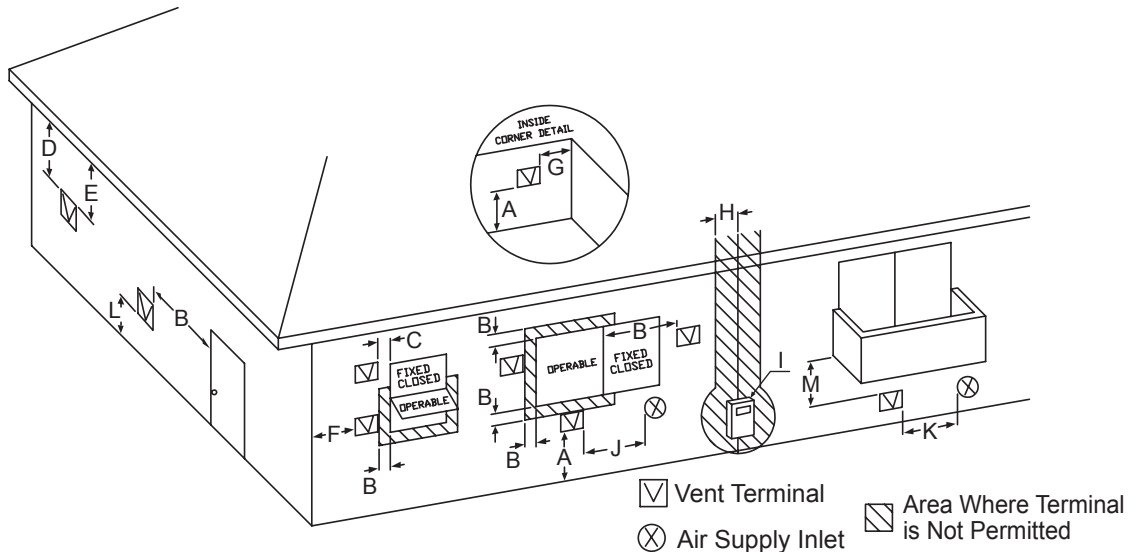

Ref	Description	Canadian Non-Direct Vent Installations ¹	US Non-Direct Vent Installations ²
A=	Clearance above grade, veranda, porch, deck, or balcony	12 in (30 cm)	12 in (30 cm)
B=	Clearance to window or door that may be opened	36 in (91 cm)	4 ft (1.2 m) below or to side of opening; 1 ft (30 cm) above opening
C=	Clearance to permanently closed window	*	*
D=	Vertical clearance to ventilated soffit located above the terminal within a horizontal distance of 2 feet (61 cm) from the center line of the terminal	*	*
E=	Clearance to unventilated soffit	*	*
F=	Clearance to outside corner	*	*
G=	Clearance to inside corner	*	*
H=	Clearance to each side of center line extended above meter/regulator assembly	3 ft (91 cm) within a height 15 ft (4.6 m) above the meter/regulator assembly	*
I=	Clearance to service regulator vent outlet	3 ft (91 cm)	*
J=	Clearance to nonmechanical air supply inlet to building or the combustion air inlet to any other appliance	36 in (91 cm)	4 ft (1.2 m) below or to side of opening; 1 ft (30 cm) above opening
K=	Clearance to a mechanical air supply inlet	6 ft (1.83 m)	3 ft (91 cm) above if within 10 ft (3 m) horizontally
L=	Clearance above paved sidewalk or paved driveway located on public property	7 ft (2.13 m)†	*
M=	Clearance under veranda, porch, deck, or balcony	12 in (30 cm)‡	*

¹ In accordance with the current CSA B149.1 Natural Gas and Propane Installation Code

² In accordance with the current ANSI Z223.1 / NFPA 54 National Fuel Gas Code

† A vent shall not terminate directly above a sidewalk or paved driveway that is located between two single family dwellings and serves both dwellings.

‡ Permitted only if veranda, porch, deck, or balcony is fully open on a minimum of two sides beneath the floor.

* Clearance in accordance with local installation codes and the requirements of the gas supplier. Clearance to opposite wall is 24 inches (60 cm).

7. Installation

Securing to the wall



- The weight of the device will be applied to the wall. If the strength of the wall is not sufficient, reinforcement must be done to prevent the transfer of vibration.
- Do not drop or apply unnecessary force to the device when installing. Internal parts may be damaged and may become highly dangerous.
- Install the unit on a vertical wall and ensure that it is level.

Item	Check	Illustration															
Locating Screw Holes	<div style="border: 1px solid black; padding: 5px; text-align: center;"> CAUTION </div> <ul style="list-style-type: none"> • When installing with bare hands, take caution to not inflict injury. • Be careful not to hit electrical wiring, gas, or water piping while drilling holes. <ol style="list-style-type: none"> 1. Drill a single screw hole, making sure to hit a stud. 2. Insert and tighten the screw and hang the unit by the upper wall mounting bracket. 3. Determine the positions for the remaining four screws (two for the top bracket and two for the bottom), and remove the unit. 	<p style="text-align: center;">Location of Screw Hole</p> <p style="text-align: center;">Locating Screw Holes</p>															
Mounting	<ol style="list-style-type: none"> 4. Drill holes for the remaining four screws. 5. Hang the unit again by the first screw, and then insert and tighten the remaining four screws. 6. Take waterproofing measures so that water does not enter the building from screws mounting the device. 	<p style="text-align: center;">Anchoring Screw</p>															
Structure	<ul style="list-style-type: none"> • Make sure the unit is installed securely so that it will not fall or move due to vibrations or earthquakes. 																
Installations at Elevations Above 2,000 ft.	<ul style="list-style-type: none"> • Adjust the dip switches as illustrated in the table to the right if this water heater is installed at an altitude of 2000 ft. (610m) or higher. • Disconnect power to the water heater before changing the dip switches. Failure to perform this step will result in a "73" code displayed on the remote controller and a cease in operation. If this occurs, disconnect, then reconnect power to the water heater to reset the system. <p>Note : Please refer to page 23 for the location of the dip switch bank.</p>	<p>* Do not change any other dipswitches.</p> <div style="display: flex; align-items: center;"> <div style="margin-right: 20px;"> <p>OFF</p> <p>ON</p> </div> <div> </div> </div> <p>* High elevation adjustment.</p> <table border="1" style="margin-left: auto; margin-right: auto;"> <thead> <tr> <th></th> <th>5</th> <th>6</th> </tr> </thead> <tbody> <tr> <td>0 - 2,000 ft (0 - 610m)</td> <td style="text-align: center;">○</td> <td style="text-align: center;">○</td> </tr> <tr> <td>2,001 - 4,000 ft (611 - 1,220m)</td> <td style="text-align: center;">●</td> <td style="text-align: center;">○</td> </tr> <tr> <td>4,001 - 6,000 ft (1,221 - 1,830m)</td> <td style="text-align: center;">○</td> <td style="text-align: center;">●</td> </tr> <tr> <td>6,001 - 8,000 ft (1,831 - 2,440m)</td> <td style="text-align: center;">●</td> <td style="text-align: center;">●</td> </tr> </tbody> </table> <p>ON=● OFF=○</p>		5	6	0 - 2,000 ft (0 - 610m)	○	○	2,001 - 4,000 ft (611 - 1,220m)	●	○	4,001 - 6,000 ft (1,221 - 1,830m)	○	●	6,001 - 8,000 ft (1,831 - 2,440m)	●	●
	5	6															
0 - 2,000 ft (0 - 610m)	○	○															
2,001 - 4,000 ft (611 - 1,220m)	●	○															
4,001 - 6,000 ft (1,221 - 1,830m)	○	●															
6,001 - 8,000 ft (1,831 - 2,440m)	●	●															

8. Gas Piping

Follow the instructions from the gas supplier.



CAUTION

The guidelines and examples we have provided in this manual section are for reference only. The sizing and installation of the gas system for this water heater, as with any gas appliance, is the sole responsibility of the installer. The installer must be professionally trained to do such work and must always follow all local and national codes and regulations. Gas line sizing calculations must be performed for every installation. Please contact Noritz America at 866-766-7489 if you have any questions or concerns.

Gas Type

The gas type indicated on the water heater rating plate (NG or LP) must match the type of gas being supplied to the water heater.

Gas Conversions

If the gas type supplied does not match the gas type on the rating plate, obtain a replacement unit with the proper gas type. If a gas type conversion must be made, there are conversion kits available for some models. [The conversion kit shall be installed by a qualified service agency in accordance with the manufacturer's instructions and all applicable codes and requirements of the authority having jurisdiction. The qualified service agency is responsible for the proper installation of this kit. Improper installation of this kit will void the warranty.]

Meter

The gas meter must be sized properly for the water heater and other gas appliances to operate properly. Select a gas meter capable of supplying the entire btuh demand of all gas appliances in the building.



CAUTION

Regulators

Ensure that all gas regulators used are operating properly and providing gas pressures within the specified range of the water heater being installed. Excess gas inlet pressure may cause serious accidents.



WARNING

Pressure

Check the gas supply pressure immediately upstream at a location provided by the gas company. Supplied gas pressure must be within the limits shown in the specifications section with all gas appliances operating. The inlet gas pressure must be within the range specified. This is for the purposes of input adjustment. Low gas pressure may cause a loss of flame or ignition failure at other appliances in the home, which may result in unburned gas in the home. Serious accidents such as fire or explosion may result.

Measuring Gas Pressure

In order to check the gas supply pressure to the unit, a tap is provided on the gas inlet. Remove the **9/32" hex head/Philips screw** from the tap, and connect a manometer using a silicon tube. Open up at least 2 fixtures and hold in the maximum manifold pressure button on the circuit board. Please call Noritz for details.

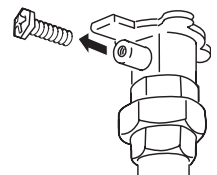

 **WARNING**

Pressure Test

The appliance and its gas connections must be leak tested before placing the appliance in operation. The appliance must be isolated from the gas supply piping system by closing its individual manual shutoff valve during any pressure testing of the gas supply piping system at test pressures equal to or less than ½ psig (3.5 kPa). We do not recommend pressure testing in excess of ½ psig (3.5kPa). If it must be done, the appliance and its individual shutoff valve must be completely disconnected from the gas supply piping system during the test process.

Pipe Sizing/Flexible Connectors

A gas shutoff valve must be installed on the supply line. Gas flex lines are not recommended unless the minimum inside diameter is ¾" or greater and the rated capacity of the connector is equal to or greater than the BTU capacity of the water heater. Gas piping shall be in accordance with local utility company requirements and/or in the absence of local codes, use the latest edition of National Fuel Gas Code (NFPA54GC), ANSI Z223.1. Size the gas line according to total btuh demand of the building and length from the meter or regulator so that the following supply pressures are available even at maximum demand.

Natural Gas Supply Pressure
Min 4" WC
Max 10.5" WC

LP Gas Supply Pressure
Min 8" WC
Max 14" WC

Reference Tools & Sample Calculations

 **CAUTION**

The tables and samples below are for reference only. The professional sizing and installing the gas line should always run the appropriate calculations before all installations.

Which Table to Use

- For NG installations with the initial supply pressure at point of delivery (at the meter, for example) is less than 8" WC, use the 0.5" WC pressure drop table (Table 1).
- For NG installations with the initial supply pressure at point of delivery is greater than or equal to 8" WC, use the 3.0" pressure drop table (Table 2).
- For all LP installation use (Table 3)

The inlet pressure must be at least 5" WC for NG or 8" WC for LP for all appliances in the gas system. If the inlet gas pressure drops below 5" WC for NG or 8" WC for LP, the heater may continue to operate, but the other appliances in the house may experience flame loss or ignition failure, which can result in gas leakage into the home. Refer to the NFPA 54 for details.

Please contact Noritz for details. For corrugated stainless steel tubing (CSST) capacity tables, please consult with the manufacturer.

Table 1. For Less than 8" WC initial supply pressure

Maximum Natural Gas Delivery Capacity (0.5" Pressure Drop) [Schedule 40 Metallic Pipe]

Pipe Size	Length (including fittings)										
	10'	20'	30'	40'	50'	60'	70'	80'	90'	100'	125'
	(3m)	(6m)	(9m)	(12m)	(15m)	(18m)	(21m)	(24m)	(27m)	(30m)	(38m)
3/4"	360	247	199	170	151	137	126	117	110	104	92
1"	678	466	374	320	284	257	237	220	207	195	173
1 1/4"	1,390	957	768	657	583	528	486	452	424	400	355
1 1/2"	2,090	1,430	1,150	985	873	791	728	677	635	600	532
2"	4,020	2,760	2,220	1,900	1,680	1,520	1,400	1,300	1,220	1,160	1,020
2 1/2"	6,400	4,400	4,400	3,020	2,680	2,430	2,230	2,080	1,950	1,840	1,630
3"	11,300	7,780	7,780	5,350	4,740	4,290	3,950	3,760	3,450	3,260	2,890
4"	23,100	15,900	12,700	10,900	9,660	8,760	8,050	7,490	7,030	6,640	5,890

Values in Table are in Cubic Feet of Gas per Hour (0.60 Specific Gravity, 0.5" Pressure Drop, inlet pressure less than 2psi). Contact your gas supplier for BTU/Cubic Foot ratings. For simplification of your calculations, 1 Cubic Foot of Gas is approximately equivalent to 1000 BTU.

Sample Gas Line

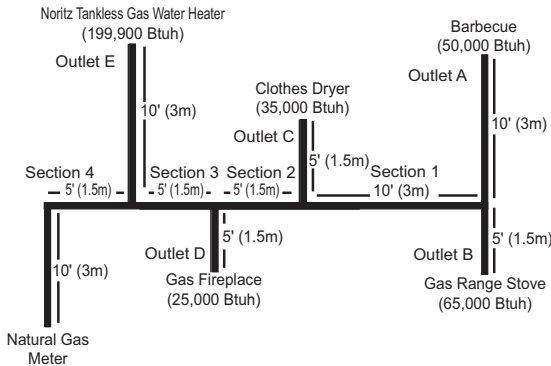

Instructions

1. Size each outlet branch starting from the furthest using the Btuh required and the length from the meter.
2. Size each section of the main line using the length to the furthest outlet and the Btuh required by everything after that section.

Sample Calculation - (Using 0.5" WC Pressure Drop Table)

- Outlet A: 45' (13.5m) (Use 50' (15m)), 50,000 Btuh requires 1/2"
- Outlet B: 40' (12m), 65,000 Btuh requires 1/2"
- Section 1: 45' (13.5m) (Use 50' (15m)), 115,000 Btuh requires 3/4"
- Outlet C: 30' (9m), 35,000 Btuh requires 1/2"
- Section 2: 45' (13.5m) (Use 50' (15m)), 150,000 Btuh requires 3/4"
- Outlet D: 25' (7.5m) (Use 30' (9m)), 25,000 Btuh requires 1/2"
- Section 3: 45' (13.5m) (Use 50' (15m)), 175,000 Btuh requires 1"
- Outlet E: 25' (7.5m) (Use 30' (9m)), 199,900 Btuh requires 3/4"
- Section 4: 45' (13.5m) (Use 50' (15m)), 355,000 Btuh requires 1 1/4"

Table 2. For 8" WC – 10.5" WC initial supply pressure

Maximum Natural Gas Delivery Capacity (3.0" Pressure Drop) [Schedule 40 Metallic Pipe]

Pipe Size	Length (including fittings)										
	10'	20'	30'	40'	50'	60'	70'	80'	90'	100'	125'
	(3m)	(6m)	(9m)	(12m)	(15m)	(18m)	(21m)	(24m)	(27m)	(30m)	(38m)
1/2"	454	312	250	214	190	172	158	147	138	131	116
3/4"	949	652	524	448	397	360	331	308	289	273	242
1"	1,787	1,228	986	844	748	678	624	580	544	514	456
1 1/4"	3,669	2,522	2,025	1,733	1,536	1,392	1,280	1,191	1,118	1,056	936
1 1/2"	5,497	3,778	3,034	2,597	2,302	2,085	1,919	1,785	1,675	1,582	1,402
2"	10,588	7,277	5,844	5,001	4,433	4,016	3,695	3,437	3,225	3,046	2,700
2 1/2"	16,875	11,598	9,314	7,971	7,065	6,401	5,889	5,479	5,140	4,856	4,303
3"	29,832	20,503	16,465	14,092	12,489	11,316	10,411	9,865	9,087	8,584	7,608
4"	43,678	30,020	24,107	20,632	18,286	16,569	15,243	14,181	13,305	12,568	11,139

Values in Table are in Cubic Feet of Gas per Hour (0.60 Specific Gravity, 3.0" Pressure Drop, 8.0" WC or greater supply pressure, inlet pressure less than 2psi). Contact your gas supplier for BTU/Cubic Foot ratings. For simplification of your calculations, 1 Cubic Foot of Gas is approximately equivalent to 1000 BTU.

Sample Gas Line

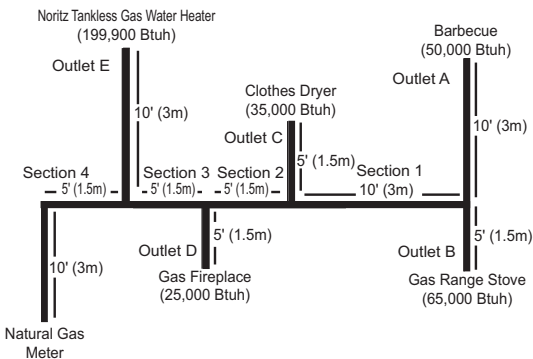

Instructions

1. Size each outlet branch starting from the furthest using the Btuh required and the length from the meter.
2. Size each section of the main line using the length to the furthest outlet and the Btuh required by everything after that section.

Sample Calculation (Using 3.0" WC Pressure Drop Table)

- Outlet A: 45' (13.5m) (Use 50' (15m)), 50,000 Btuh requires 1/2"
- Outlet B: 40' (12m), 65,000 Btuh requires 1/2"
- Section 1: 45' (13.5m) (Use 50' (15m)), 115,000 Btuh requires 1/2"
- Outlet C: 30' (9m), 35,000 Btuh requires 1/2"
- Section 2: 45' (13.5m) (Use 50' (15m)), 150,000 Btuh requires 1/2"
- Outlet D: 25' (7.5m) (Use 30' (9m)), 25,000 Btuh requires 1/2"
- Section 3: 45' (13.5m) (Use 50' (15m)), 175,000 Btuh requires 1/2"
- Outlet E: 25' (7.5m) (Use 30' (9m)), 199,900 Btuh requires 1/2"
- Section 4: 45' (13.5m) (Use 50' (15m)), 355,000 Btuh requires 3/4"

Table 3. Maximum Undiluted Propane (LP) Delivery Capacity in Thousands of BtuH (0.5" WC Pressure Drop) [Schedule 40 Metallic Pipe]

Pipe Size	Length (including fittings)												
	10' (3m)	20' (6m)	30' (9m)	40' (12m)	50' (15m)	60' (18m)	70' (21m)	80' (24m)	90' (27m)	100' (30m)	125' (38m)	150' (45m)	200' (60m)
1/2"	275	189	152	129	114	103	96	89	83	78	69	63	55
3/4"	567	393	315	267	237	217	196	185	173	162	146	132	112
1"	1,071	732	590	504	448	409	378	346	322	307	275	252	213
1 1/4"	2,205	1,496	1,212	1039	913	834	771	724	677	630	567	511	440
1 1/2"	3,307	2,299	1,858	1,559	1,417	1,275	1,181	1,086	1,023	976	866	787	675
2"	6,221	4,331	3,465	2,992	2,646	2,394	2,205	2,047	1,921	1,811	1,606	1,496	1,260

For reference only. Please consult gas pipe manufacturer for actual pipe capacities.



Final Check

When the installation is complete, verify that inlet gas pressure for the entire gas system does not drop below 5" WC for NG or 8" WC for LP at all appliances. This can be tested by turning on all gas burning appliances including the water heater, then check the inlet pressure at each appliance to verify all appliances are receiving a minimum of 5" WC for NG or 8" WC for LP. If all appliances are not receiving the minimum inlet pressure the gas piping system may need to be changed.

9. Water Piping

Installation and service must be performed by a qualified plumber. In the Commonwealth of Massachusetts, this product must be installed by a licensed plumber or gas fitter in accordance with the Massachusetts Plumbing and Fuel Gas Code 248 CMR Sections 2.00 and 5.00. Observe all applicable codes.

This appliance is suitable for combination potable water and space heating applications. It cannot be used for space heating applications only. Do not use this appliance if any part has been underwater. Immediately call a qualified service technician to inspect the appliance and replace any part of the control system and gas control which has been under water.

If the water heater is installed in a closed water supply system, such as one having a backflow preventer in the cold water supply line, means shall be provided to control thermal expansion. Contact the water supplier or a local plumbing inspector on how to control this situation.

A pressure relief valve must be installed near the hot water outlet that is rated in accordance with and complying with either The Standard for Relief Valves and Automatic Shutoff Devices for Hot Water Supply Systems, ANSI Z21.22, or The ANSI/ASME Boiler and Pressure Vessel Code, Section IV (Heating Boilers). This pressure relief valve must be capable of an hourly Btu rated temperature steam discharge of 199,900 Btuh. Multiple valves may be used. The pressure relief capacity must not exceed 150 psig. No valve shall be placed between the relief valve and the water heater. The relief valve must be installed such that the discharge will be conducted to a suitable place for disposal when relief occurs. No reducing coupling or other restriction may be installed in the discharge line. The discharge line must be installed to allow complete drainage of both the valve and the line. If this unit is installed with a separate storage vessel, the separate vessel must have its own temperature and pressure relief valve. This valve must also comply with The Standard for Relief Valves and Automatic Gas Shutoff Devices for Hot Water Supply Systems, ANSI Z21.22. (in the U.S. only). A temperature relief valve is not required, but if one is used, do not install the valve with the probe directly in the flow of water. This may cause unwarranted discharge of the valve.

Piping and components connected to the water heater shall be suitable for use with potable water.

Toxic chemicals, such as those used for boiler treatment, shall not be introduced into the potable water.

A water heater used to supply potable water may not be connected to any heating system or components previously used with a nonpotable water heating appliance.

When water is required in one part of the system at a higher temperature than in the rest of the system, means such as a mixing valve shall be installed to temper the water to reduce the scald hazard.

- Flush water through the pipe to clean out metal powder, sand and dirt before connecting it.
- Perform the following insulation measures for prevention of freezing.
 - Take appropriate heat insulation measures (e.g., wrapping with heat insulation materials, using electric heaters) according to the climate of the region to prevent the pipe from freezing.
 - Make sure that there are no water leaks from the cold and hot water supply pipes, then insulate the pipes completely.
 - Be sure to also completely insulate the water supply valve and the cold and hot water connections on the water heater (refer to the figure on the right).
 - Do not cover the water drain plug with insulation so that water in the pipe can be drained. (Refer to the figure in the right.)
- Use a union coupling or flexible pipe for connecting the pipes to reduce the force applied to the piping.
- Do not use piping with a diameter smaller than the coupling.
- When feed water pressure is too high, insert a depressurizing valve, or take water hammer prevention measure.
- Avoid using joints as much as possible to keep the piping simple.
- Avoid piping in which an air holdup can occur.
- If installing the unit on a roof:
- About lower-level hot water supply

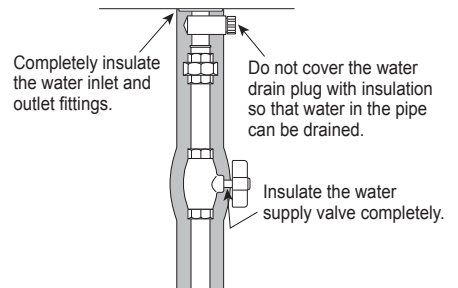

If the unit is installed on a roof to supply water to the levels below, make sure that the water pressure supplied to the unit does not drop below 29 psi. It may be necessary to install a pump system to ensure that the water pressure is maintained at this level.

Check the pressure before putting the unit into operation.

Failure to supply the proper pressure to the unit may result in noisy operation, shorter lifetime of the unit, and may cause the unit to shut down frequently.

Supply water piping

- Do not use PVC, iron, or any piping which has been treated with chromates, boiler seal or other chemicals.
- Mount a check valve and a shut off valve (near the inlet).
- In order for the client to use the water heater comfortably, 98.1 to 491 kPa (14 to 70 PSI) of pressure is needed from the water supply. Be sure to check the water pressure. If the water pressure is low, the water heater cannot perform to its full capability, and may become a source of trouble for the client.

Drain piping

- Expansion water may drop from the pressure relief valve and wet the floor. If necessary, provide drain piping or use a drain hose to remove the water.

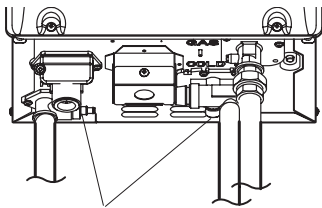

Pressure relief valve

Hot water piping

- Do not use lead, PVC, iron or any piping which has been treated with chromates, boiler seal or other chemicals.
- The longer the piping, the greater the heat loss. Try to make the piping as short as possible.
- Use mixing valves with low water resistance. Use shower heads with low pressure loss.
- If necessary, use a pump or other means to ensure that the supply water pressure to the inlet of the heater does not fall below 29 PSI when the maximum amount of water is being demanded. Also install a pressure meter on the inlet. If this is not done, local boiling will occur inside the water heater causing abnormal sounds and decreasing the durability of the heat exchanger.

Freeze Prevention

- Freezing is prevented within the device automatically unless the outside temperature without wind is below -4°F (-20°C).
- If this model is installed in an area where the outside temperature can approach freezing conditions of -4°F (-20°C) or below, then additional freeze protection measures must be used. For temporary freeze protection measures, refer to the Owner's Guide.
- The freeze prevention heaters will not prevent the plumbing external to the unit from freezing. Protect this plumbing with insulation, heat tape or electric heaters, solenoids, or pipe covers.
- In order for the freeze prevention heaters to operate, the water heater must have power at all times.

Damage to the water heater as a result of the below is not covered by the Noritz America Limited Warranty.

- Water in excess of 12 gpg (200mg/L) of hardness
- Poor water quality (see table to the right)

Total Hardness*	: 200 mg/L (12 gpg) or less
Aluminum	: 0.05 to 0.2 mg/L or less
Chloride	: 250 mg/L or less
Copper	: 1 mg/L or less
Iron	: 0.3 mg/L or less
Manganese	: 0.05 mg/L or less
pH	: 6.5 - 8.5
Total Dissolved Solids	: 500 mg/L or less
Zinc	: 5 mg/L or less
Sulfate ion	: 250 mg/L or less
Residual chlorine	: 4 mg/L or less

* Maximum limit suggested by Noritz.

Water Treatment

If this water heater will be installed in an application where the supply water is hard, the water must be treated with either the Noritz H2Flow or ScaleShield or a water softener. Refer to the below tables for suggested treatment and maintenance measures to be taken based on the water hardness level. If this water heater will be installed in an application where the supply water is hard, Scale Build-up may cause damage to the Heat Exchanger. In this case, this water heater detects Scale Build-up in the Heat Exchanger and then the error code "C*#" will flash on the Remote Controller. When the error code "C*#" is displayed, the Heat Exchanger needs to be flushed to prevent damage from Scale Build-up. Refer to the "Procedure for flushing the Heat Exchanger" on page 16 or contact Noritz America for more information. (<http://support.noritz.com/> or 866-766-7489)

* * = 1, 2, 3, 4, F
= 0, 1, 2, 3, 4, 5, 6, 7, 8, 9

Damage to the water heater as a result of the items below is not covered by the Noritz America Limited Warranty.

- Water in excess of 12 gpg (200mg/L) of hardness
- Poor water quality (See the Water Quality List on page 14.)
- The water heater has displayed a "C*#" error code indicating Scale Build-up, but the heat exchanger has not been flushed.

Note: Water softeners may be regulated by the local water jurisdiction, consult with the manufacturer for code, sizing, and installation guidelines; the below diagram is for reference only. For more information about H2Flow and ScaleShield, contact Noritz America at <http://support.noritz.com/> or 866-766-7489.

Treatment Guidelines

Type of Water	Hardness Level	Treatment Device*	Flush Frequency**	
			Residential Use	Commercial Use
Soft	0-1 gpg (0-17 mg/L)	None	None	None
Slightly Hard	1-3 gpg (17-51 mg/L)	None	None	None
Moderately Hard	3-7 gpg (51-120 mg/L)	H2Flow or ScaleShield	Once a Year*** or Flushing the error code****	Once a Year*** or Flushing the error code****
Hard	7-10 gpg (120-171 mg/L)	H2Flow or ScaleShield	Once a Year*** or Flushing the error code****	Twice a Year*** or Flushing the error code****
Very Hard	10-12 gpg (171-200 mg/L)	H2Flow or Water Softener	Once a Year*** or Flushing the error code****	Twice a Year*** or Flushing the error code****
Extremely Hard	> 12 gpg (> 200 mg/L)	H2Flow or Water Softener	Once a Year*** or Flushing the error code****	Twice a Year*** or Flushing the error code****

* When selecting a treatment device, you must consult with the device's spec sheet and installation manual for guidelines and limitations. Not all water supplies are compatible - a water test may be required.
 ** Install Noritz Isolation Valves to allow for flushing.
 *** Flushing is required if a water treatment device is not installed.
 **** The error code "C*#" will be flashing in the Display Window.
 * = 1, 2, 3, 4, F
 # = 0, 1, 2, 3, 4, 5, 6, 7, 8, 9

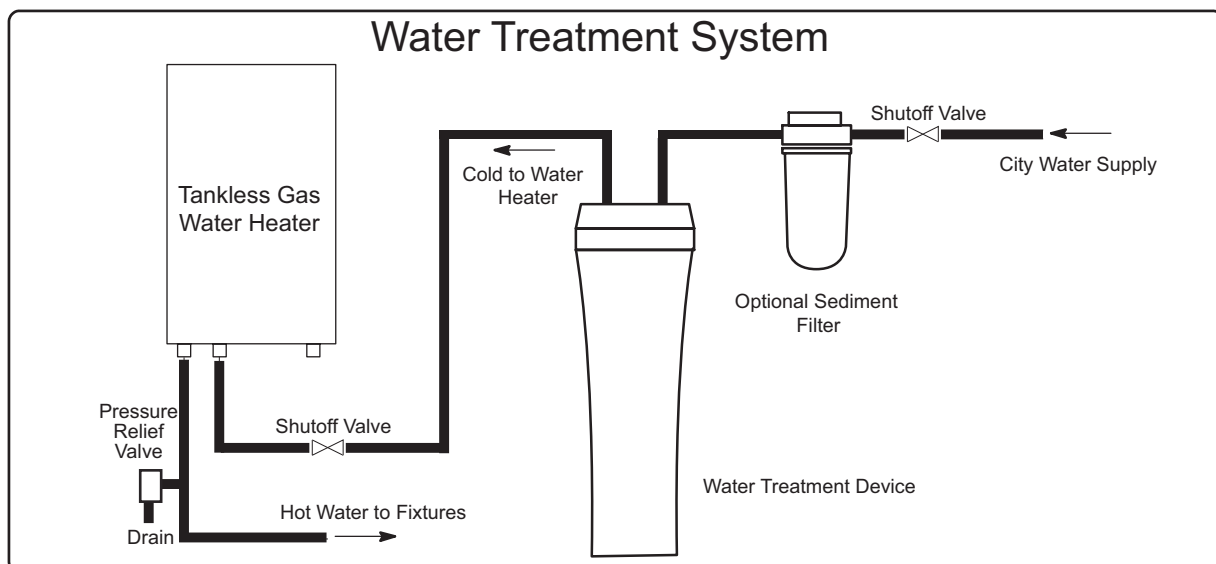

▲ The illustration is an example. Please check with the actual water heater about the position of piping, and form.

Procedure for Flushing the Heat Exchanger

This procedure is only intended for use by a qualified service professional or authorized Noritz Service Representative. Any unauthorized use of this procedure may result in voiding the warranty. Please contact Noritz America (866-766-7489) for additional support.

If the error code “C*#*~C*#*” is flashing on the Remote Controller (or Operation Panel**), it means there is Scale Build-up in the Heat Exchanger. The Heat Exchanger needs to be flushed*** to remove the Scale Build-up.

Damage to the water heater due to Scale Build-up is not covered by the water heater's warranty.
To clear the error code “C*#*~C*#*”, the Heat Exchanger must be flushed.

If the error code “C*#*” is displayed and flashing on the Remote Controller (or Operation Panel**), please contact Noritz America (866-766-7489).

* * = 1, 2, 3, 4, F / # = 0, 1, 2, 3, 4, 5, 6, 7, 8, 9

** NR98DVC(GQ-2857WX-FFA US) and NR83DVC(GQ-2457WS-FFA US) only.

*** Connect the “blue connector for flushing” near the Circuit Board when flushing the Heat Exchanger.
After connecting it, the water heater is set to “Flushing Mode”.

The water heater must remain connected to electrical power when flushing the Heat Exchanger.

Basic Procedure

«Procedure 1. The preparation of the flushing system»

1. Close the gas supply valve.
2. Close the water inlet valve (V1) and the water outlet valve (V2).
3. Connect the one drain hose (H1) to the drain valve (V3), and then the other to the circulating pump.
4. Connect the drain hose (H2) to the circulating pump.
5. Connect the drain hose (H3) to the drain valve (V4).
6. Pour 1 gallon of “Calcium, Lime and Rust Removal Product” and 1 gallon water into the bucket.
7. Place the both drain hoses (H2 and H3) into the bucket filled with the flushing solution.
8. Open the both drain valves (V3 and V4).

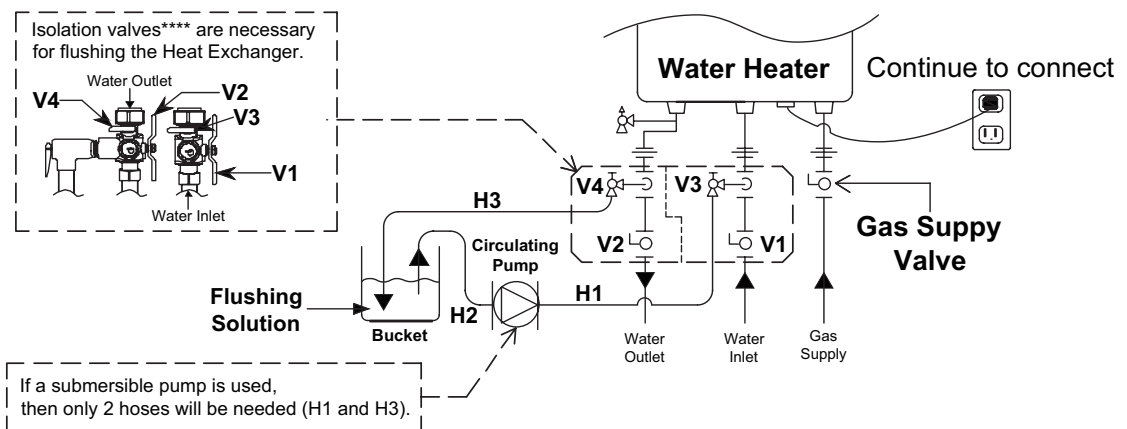

**** Isolation valves may be purchased as an accessory from an authorized Noritz wholesaler. They allow for full diagnostic testing and easy flushing of the system.
Contact Noritz America for more information.(866-766-7489)

«Procedure 2. Flushing the Heat Exchanger (For Single Unit)»

1. Open the Front Cover.
2. Connect the “blue connector*****” for flushing” near the Circuit Board.

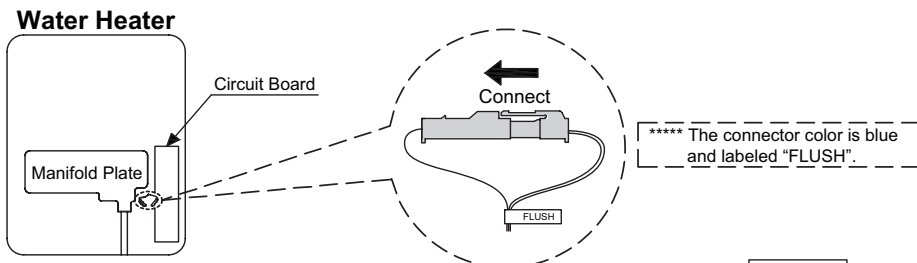

3. Then the code “CCC” is displayed on the Remote Controller. **CCC**
4. Turn on the circulating pump to circulate the flushing solution through the water heater for 1 hour at a rate of 1.5 gallons per minute or more.
5. The code “C60” is displayed on the Remote Controller when the water heater detects the flow of the flushing solution.

When 1 minute passes, the code “C60” will change to “C59” on the Remote Controller.



Please check whether the reverse connection of the hose (H1) and (H3) if the display number will not change. In that case, the flow rate of the flushing solution may be under 1.5 gallons per minute.

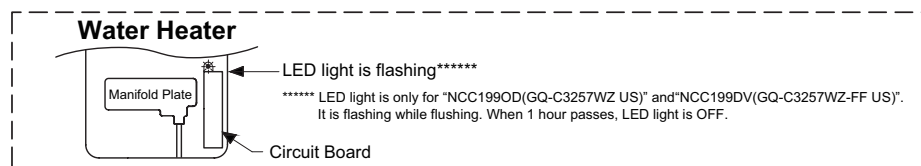

6. When 1 hour passes, the code “C00” is flashing on the Remote Controller. **C00** Flashing
7. Turn off the circulating pump.

«Procedure 3. Cleaning the Heat Exchanger»

The flushing solution needs to be rinsed and cleaned out of the water heater.

Below is the way to rinse and clean the flushing solution.

1. Remove both drain hoses (H2 and H3) from the bucket. And then place the drain hose (H3) into the sink or outside to drain.
2. Close the drain valve (V3) and then open the water inlet valve (V1). Do not open the fresh water outlet valve (V2).
3. Clean the water heater with fresh water for 3 minutes or more. (Needs to have enough time to clean the water heater.)

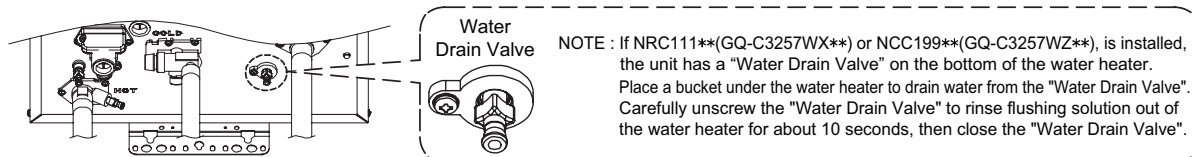

4. Close the drain valve (V4) and then remove the drain hose (H3) from the drain valve (V4).
5. Remove the drain hose (H1) from the drain valve (V3).
6. Disconnect the “blue connector for flushing” near the Circuit Board. The code “C00” goes out on the Remote Controller.
7. Close the Front Cover.
8. Open the gas supply valve and water outlet valve (V2).
9. Check for correct operation of the water heater.

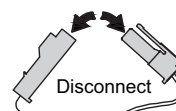

In case of the “Quick Connect Multi System Procedure”

1. Connect the “blue connector for flushing” of need to be flushed.
(The water heater is isolated from Quick Connect Multi system when the “blue connector for flushing” is connected. Not need to disconnect the Quick Connect Cord.)

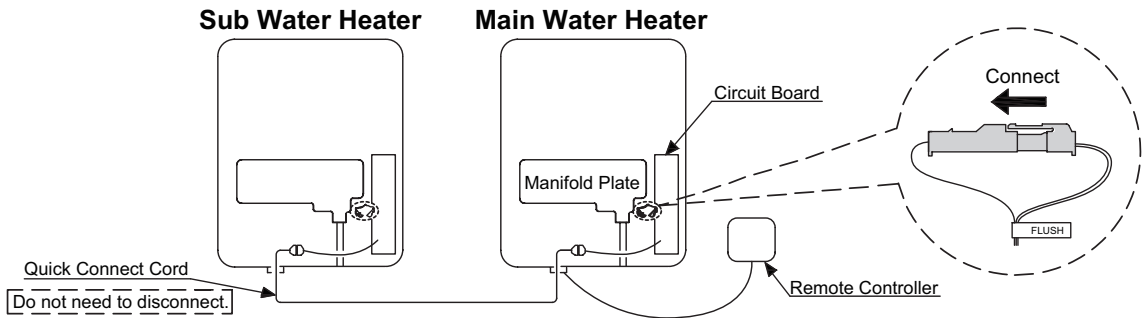

2. Then the code “CCC” or “FCC” is displayed on the Remote Controller.

CCC is displayed when the Main Water Heater’s blue connector is connected.

FCC is displayed when the Sub Water Heater’s blue connector is connected.

2. Turn on the circulating pump to circulate the flushing solution through the water heaters for 1 hour at a rate of 1.5 gallons per minute or more.
(LED light is flashing while flushing the heat exchanger. See the “Procedure 2.5”.)
3. When 1 hour passes, the code “C00” is flashing on the Remote Controller.
Do not disconnect the “blue connector for flushing”.

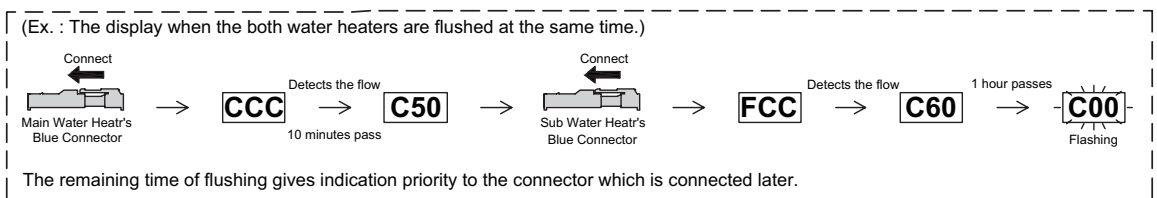
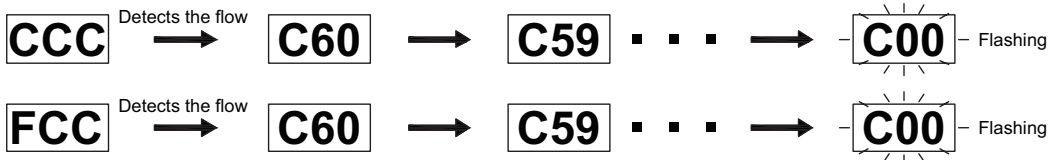

4. Turn off the circulation pump.
5. Rinse and clean the flushing solution out of the water heaters in accordance with “Procedure 3”.
(See the “Procedure 3.1–3.5”.)

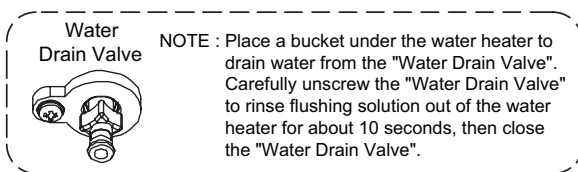

6. Disconnect the “blue connector for flushing”. The Code “C00” goes out on the Remote Controller.
7. Close the Front Covers.
8. Open the gas supply valves and water out let valves.
9. Check for correct operation of the water heaters.

In case of the “Multi System Procedure”

1. Connect the “blue connector for flushing” of need to be flushed.
(The water heater is isolated from Multi System when the “blue connector for flushing” is connected. Not need to disconnect the “Cord for the Multi System” .)

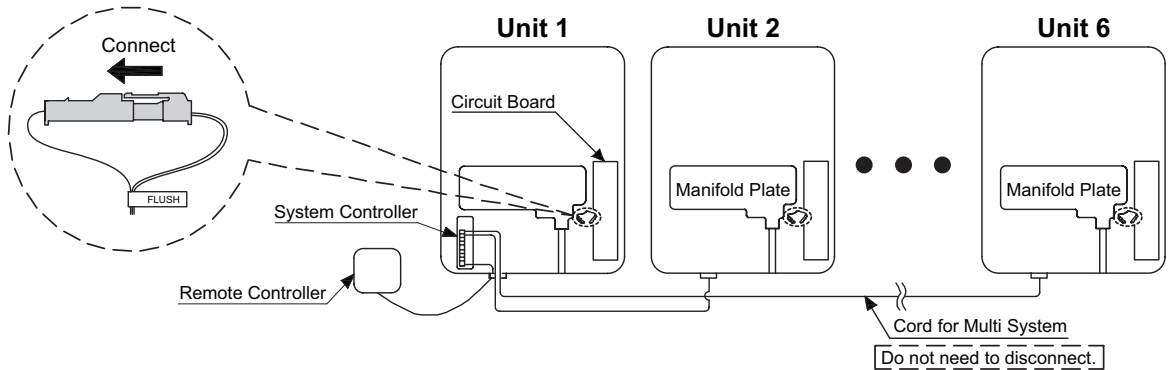

2. Then the code “CCC” is displayed on the Remote Controller and the error alarm continuously sounds. Press the “ALARM OFF” button to stop the error alarm.

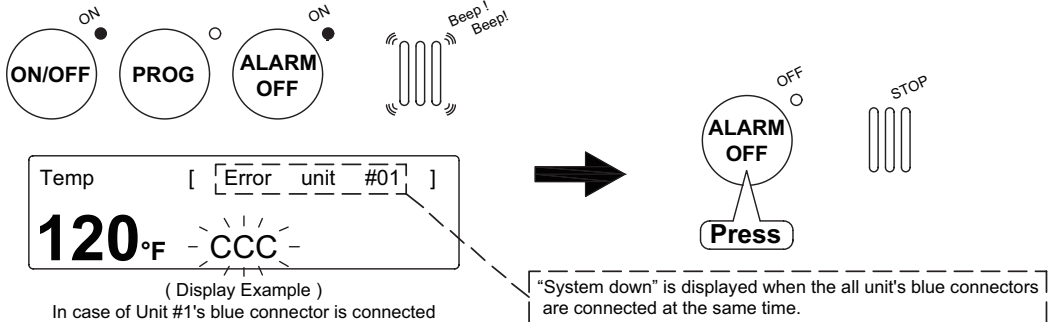

3. Turn on the circulating pump to circulate the flushing solution through the water heaters for 1 hour at a rate of 1.5 gallons per minute or more.
Note : The code “CCC” does not change when Multi System mode. The display does not show the remaining time of flushing.
4. Check for the remaining time of flushing to see the Maintenance Monitor #80 (MM #80).

«How to check the remaining time of flushing»

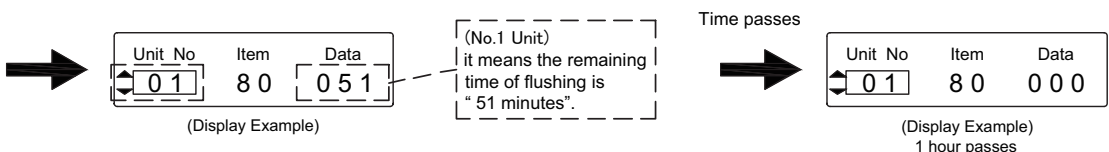

Press either “ENTER” button (ENTER) in order to move () .

And then press either “▲” or “▼” button () in order to switch the Unit No.

5. When 1 hour passes, turn off the circulation pump.
(LED light is flashing while flushing the heat exchanger. See the "Procedure 2.5".)
6. Rinse and clean the flushing solution out of the water heaters in accordance with "Procedure 3".
(See the Procedure 3.1~3.5.)

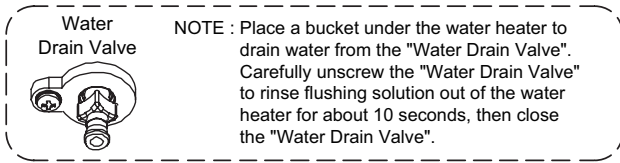

7. Disconnect the "blue connector for flushing". The Code "CCC" goes out on the Remote Controller.
8. Close the Front Covers.
9. Open the gas supply valves and water outlet valves.
10. Check for correct operation of the water heaters.

Please contact Noritz America if more information is needed for flushing.
(Phone # : 866-766-7489)

10. Plumbing Applications

Recirculation System

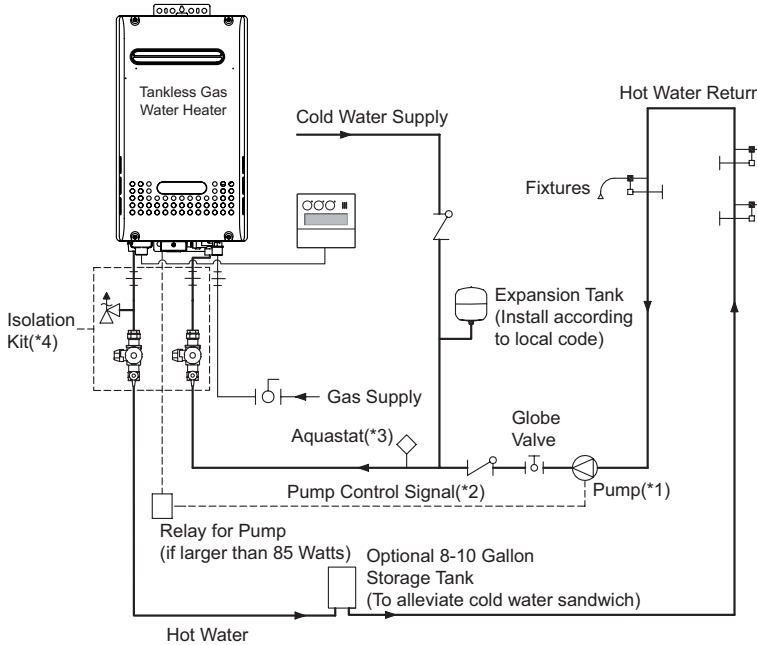

Notes:

1. Size the pump to provide a maximum of 2 GPM (7.5 L/min.) through the system at 10 ft (3m) of head plus piping losses. Adjust the flow using a globe valve and verify the flow rate with the maintenance monitors.
2. Pump Control Signal is the preferred method to control the recirculation pump. For pumps larger than 85W, a relay connection must be used. If the Pump Control Signal is not used, an Aquastat may be used to control the pump.
3. Set the Aquastat to 10° F below the set output temperature. An Aquastat is the minimum pump control requirement in order to maintain the full recirculation warranty. If it is not installed, the water heater can not detect the Scale Build-up in the Heat Exchanger.
4. Noritz recommends the use of an Isolation Kit with the installation. These kits include an integrated shut-off and service valve with unions and a pressure relief valve.

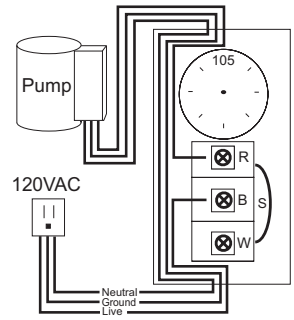

Aquastat Wiring
Use Honeywell Aquastat
(Model L6006A or L6006C)

Combination Potable Water and Space Heating System

If the Air Handler does not control the water flow automatically, the Scale detection feature will not work.

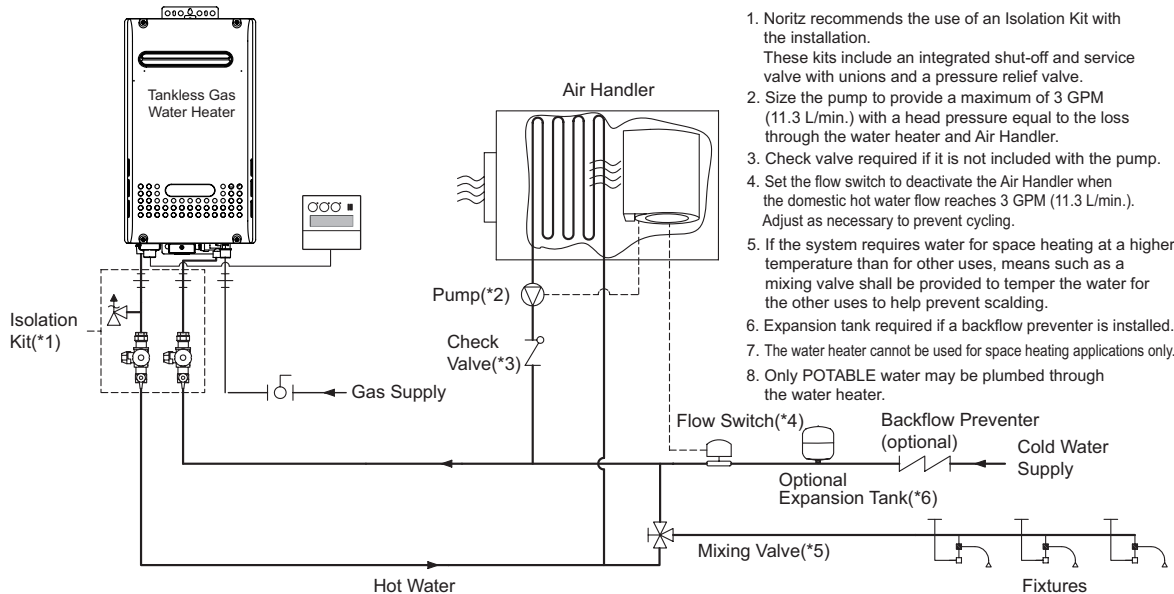

Notes:

1. Noritz recommends the use of an Isolation Kit with the installation. These kits include an integrated shut-off and service valve with unions and a pressure relief valve.
2. Size the pump to provide a maximum of 3 GPM (11.3 L/min.) with a head pressure equal to the loss through the water heater and Air Handler.
3. Check valve required if it is not included with the pump.
4. Set the flow switch to deactivate the Air Handler when the domestic hot water flow reaches 3 GPM (11.3 L/min.). Adjust as necessary to prevent cycling.
5. If the system requires water for space heating at a higher temperature than for other uses, means such as a mixing valve shall be provided to temper the water for the other uses to help prevent scalding.
6. Expansion tank required if a backflow preventer is installed.
7. The water heater cannot be used for space heating applications only.
8. Only POTABLE water may be plumbed through the water heater.

11. Electrical Wiring

Consult a qualified electrician for the electrical work.



Do not connect electrical power to the unit until all electrical wiring has been completed.

This appliance must be electrically grounded in accordance with local codes, or in the absence of local codes, with the National Electrical Code, ANSI/NFPA 70. In Canada, the latest CSA C22.1 Electrical Code.

Caution: Label all wires prior to disconnection when servicing controls. Wiring errors can cause improper and dangerous operation.

Verify proper operation after servicing.

Field wiring to be performed at time of appliance installation.

WARNING

Electrical Shock Hazard

Do not turn power on until electrical wiring is finished. Disconnect power before servicing. Failure to do so may result in death or serious injury from electrical shock.

- The electrical supply required by the water heater is 120VAC at 60 Hz. The power consumption may be up to 228W or higher if using optional accessories. Use an appropriate circuit.
- Do not disconnect the power supply when not in use. When the power is off, the freeze prevention in the water heater will not activate, resulting in possible freezing damage.

- Do not let the power cord contact the gas piping.

Tie the redundant power cord outside the water heater. Putting the redundant length of cord inside the water heater may cause electrical interference and faulty operation.

Ground

- To prevent electrical shock, provide a ground with resistance less than $100\ \Omega$. An electrician should do this work.
- A grounding screw is provided on the back in the junction box.

Do not connect the ground to the city water or gas piping. Do not tie the ground to a telephone line.

Breaker Installation

- Mount a device which shuts off the electrical path automatically (leakage breaker) when electrical leakage is detected.

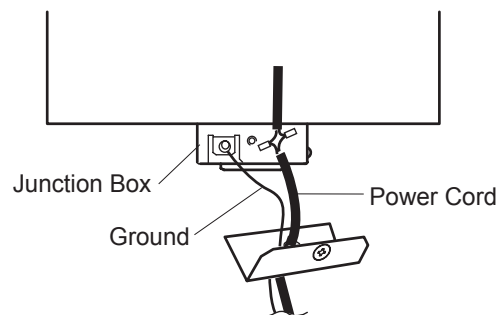

1. Remove the screw (one) of the junction box and open the cover of the junction box.
2. Connect the grounding wire to the ground screw in the cover.
3. Crimp the outdoor power cable to the power cable of the unit.

CAUTION

Electrostatic discharge can affect electronic components. Take precautions to prevent electrostatic discharges from personnel or hand tools during the water heater installation and servicing to protect product's electronic control.

Remote Controller

• Applicable Model

Remote controller	RC-9018M
-------------------	----------

Install the remote controller according to the instructions in the Installation Guide. (p. 35).

* Only one remote controller can be connected to the water heater.

A malfunction may occur if two or more remote controllers are connected.

• This unit can be programmed so that it will default to one of four temperatures if the remote controller is removed [185°F (85°C), 140°F (60°C), 130°F (54°C), 120°F (50°C)]. To change the default temperature, adjust the dip switches as described below. The default temperature is 120°F (50°C).

1. Disconnect electrical power to the water heater.
2. Remove the front cover of the water heater (4 screws).
3. Disconnect the remote controller. Adjust the dip switches as illustrated below.
4. Replace the front cover of the water heater (4 screws).
5. Reconnect electrical power to the water.

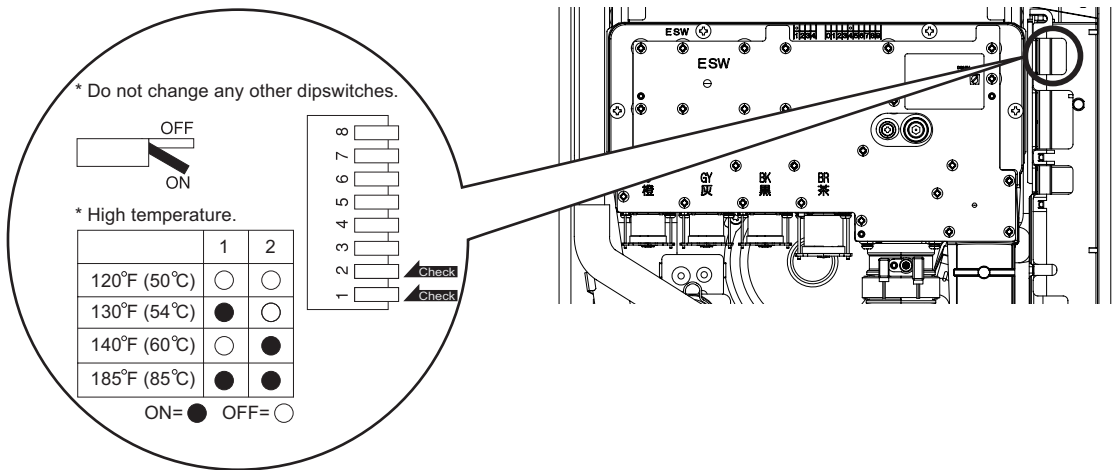

DANGER

- When changing the temperature, make sure to confirm with the customer that the temperature of the hot water will be very high and that there is a risk of scalding.
- Hot water heater temperatures over 125 °F (52 °C) can cause severe burns instantly or death from scalding.

Connecting Remote Controller Cord to Unit

- Keep the remote controller cord away from the freeze prevention heaters in the unit.
- Tie the redundant cord outside the water heater. Do not put the extra length inside the equipment.
- The remote controller cord can be extended up to 300' (90m) with 18AWG wire.
- Use a Y type terminal with a resin sleeve. (Without the sleeve, the copper wire may corrode and cause problems).
- Be sure to hand tighten when screwing to the terminal block. Power tools may cause damage to the terminal block.

Remote controller cord

- For extensions, a 26' (8m) cord can be purchased (Part # RC-CORD26) or use 18AWG wire.
- Install according to the National Electrical Code and all applicable local codes.

1. Check to make sure that the remote controller cord has plenty of slack in order to reach the external connection terminal block.
2. Disconnect electrical power to the water heater.
3. Remove the single screw securing the terminal block cover and then remove the cover.
4. Pass the remote controller cord through the wiring throughway and connect the Y terminals at the end of the remote controller cord to the terminal block.
5. Replace the terminal block cover and install the screw previously removed in step 3.
6. Reconnect electrical power to the water heater.

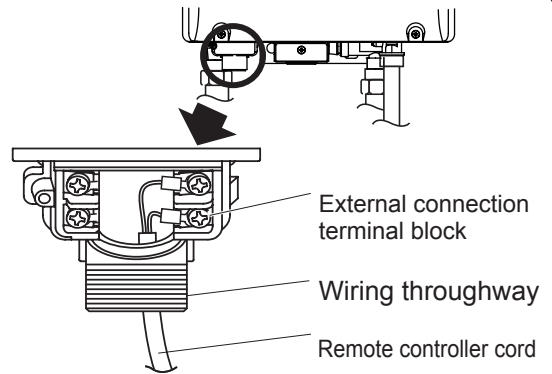

■ Changing Other Features

Adjusting the Temperature / Water Quantity Display

Note: The setting must be done within the first 10 minutes of connecting electrical power to the water heater.

Table of Setting Items

Item	Choices (factory defaults shaded)	
Celsius/Fahrenheit display mode.	°F (Fahrenheit) / gal	°C (Celsius) / L

■ Remote Controller

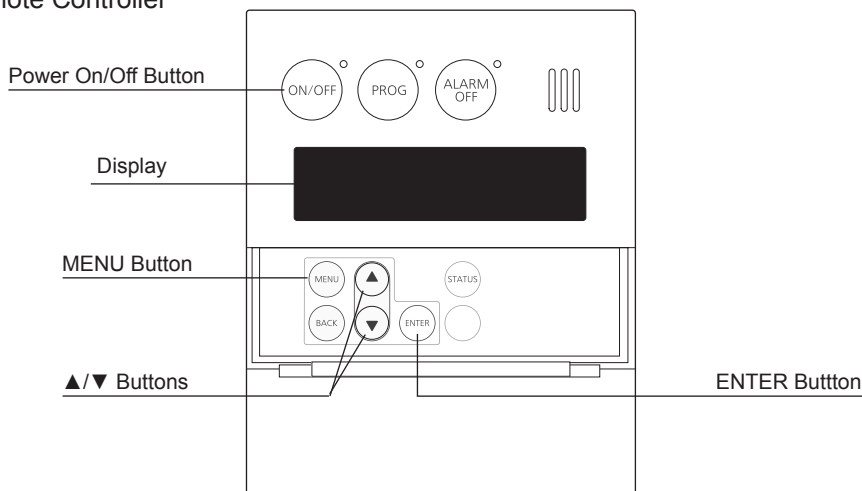

■ Setting Procedure

1. Turn the water heater off by pressing the Power On/Off Button on the remote controller.
2. Disconnect, then reconnect electrical power to the water heater.
3. Press the MENU Button inside the cover, select "Initial settings" using the ▲/▼ Buttons.
4. Press the ENTER button, the "Initial settings" screen appears on the display.
5. Select "[°F / gal] ↔ [°C / L]" using the ▲/▼ Buttons.
6. Press the ENTER Button and select either [°F / gal] or [°C / L] using the ▲/▼ Buttons.
7. Press the ENTER Button, and "Set complete Please wait..." appears on the display for 5seconds and the "Initial settings" screen appears on the display.
8. To confirm the setting, turn the water heater on by pressing the Power On/Off Button on the remote controller.

Pump Wiring

* This feature is not available when using the Quick Connect Multi System feature.

Connecting the pump control wire

1. Leave enough slack so that the pump control wires will stay connected if the unit is removed from the wall.
2. Remove the front cover of the heater (4 screws).
3. Cut off the connector at the end of the pump control wires.
4. Wire the pump control wires through the wiring throughway and connect them to the wiring inside the pump (this will be the power supply for the pump, do not also connect 120VAC to the pump).
If a large pump is being used (greater than 85W) use the voltage from these wires as the signal to close a normally open relay through which 120VAC will be supplied directly from a wall circuit to the pump.
5. Replace the front cover.

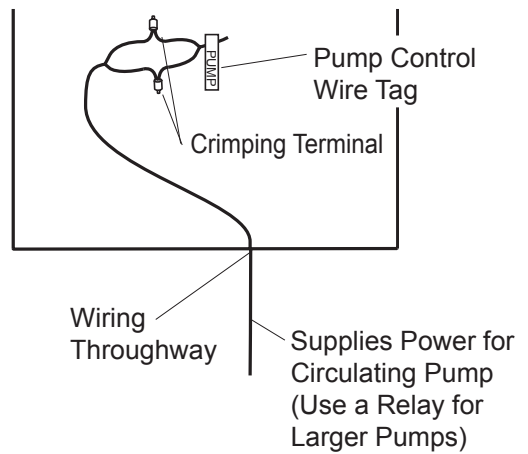

Relay connection with larger pumps (>85 W)

1. Locate and prepare the pump control wires as described above.
2. Choose a suitable installation location for the relay where it will be protected from moisture.
3. Connect the pump control wires from the heater to the signal input on the relay.
4. Cut one of the electrical supply leads and wire it across the open terminals of the relay.
5. Secure all connections and replace the front cover of the heater.

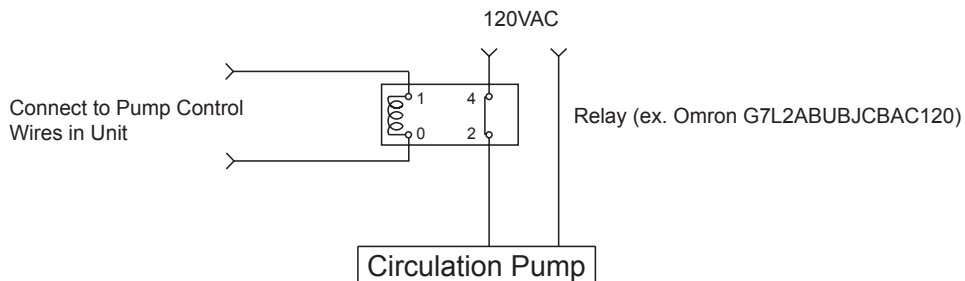

Connecting Quick Connect Cord-2

For Quick Connect Multi System Installation use part #QC-2 only. (sold separately).

Caution

The wire coloring on the Quick Connect Cord-2 will not be the same as the wire coloring of the connection plug inside the unit.

- * The remote controller can be connected to either unit A or B. Do not connect a remote controller to both units.
- * Disconnect the remote controller from either unit A or B prior to installing the Quick Connect Cord.

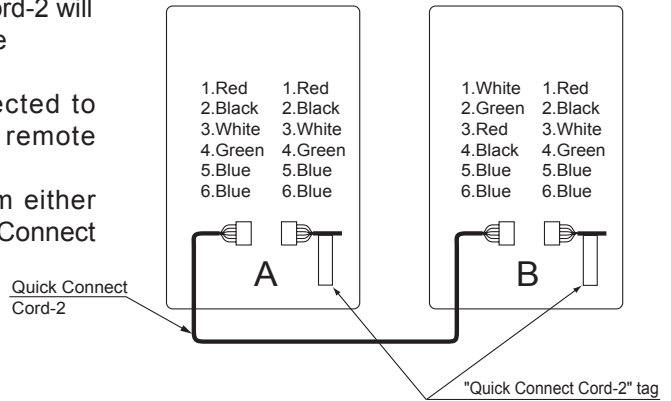

Connecting the Quick Connect Cord to the two units.

1. Turn off the power.
2. Remove the front cover of the heater (4 screws).
3. Pass the Quick Connect Cord through the wiring throughway and into the unit.
4. Plug the connector on the Quick Connect Cord to the receptacle inside the unit.
5. Attach the ground wire of the Quick Connect Cord to the terminal block fixing plate.
(If the ground wire is not attached, electrical noise may cause problems).
6. Secure the Quick Connect Cord with a clamp.
7. Replace the front cover.

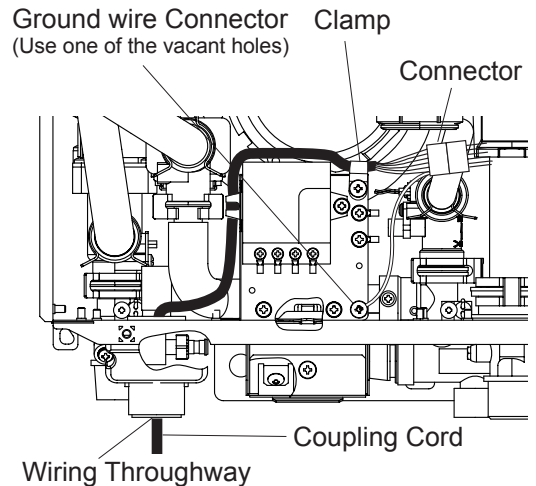

12. Maintenance

Periodically check the following to ensure proper operation of the water heater.

- The venting system must be examined periodically by a qualified service technician to check for any leaks or corrosion.
- The burner flame must be checked periodically for a proper blue color and consistency.
- If the flame does not appear normal, the burner may need to be cleaned.
- If the burner needs to be cleaned, it must be performed by a qualified service technician.
- Do not obstruct the flow of combustion and ventilation air.
- The pressure relief valve must be operated once a year to ensure that it is functioning properly and there is no obstruction. Turn the power off to the unit before opening the relief valve, and make sure that water draining out of the valve will not cause any damage.
- If the relief valve discharges periodically, it may be due to thermal expansion in a closed water system. Contact the water supplier or a local plumbing inspector on how to correct this situation. Do not plug the relief valve.
- See the Owner's Guide for further maintenance.

Warning: There is a scald potential if the output temperature is set too high.

Should overheating occur, or the gas supply fail to shut off, turn off the manual gas control valve to the appliance. Do not use this appliance if any part has been under water. Immediately call a qualified service technician to inspect the appliance and to replace any part of the control system and any gas control which has been under water. Periodically check and clean the filter inside the cold water inlet of the unit.

13. Trial Operation

The installer should test operate the unit, explain to the customer how to use the unit, and give the owner this manual before leaving the installation.

- Preparation (1) Open a hot water fixture to confirm that water is available, and then close the fixture.
(2) Open the gas supply valve.
(3) Turn on the power supply. Using the remote controller, turn on the Power On/Off button (the Operation lamp will turn on).

- (1) Open a hot water fixture and confirm that the Burner On lamp comes on, and that hot water is being produced. (If necessary, repeat until the air in the gas piping is bled out).
 - * White smoke may be noticed from the exhaust vent during cold weather. However, this is not a malfunction of the unit.
 - * If an "11" error code appears on the remote controller, turn the unit off and then back on again, and then open a hot water fixture again.
- (2) Change the temperature setting on the remote controller and check that the water temperature changes.

- If the water heater does not operate normally, refer to "Troubleshooting" in the Owner's Guide.
- * After the trial operation, clean the filter in the cold water inlet.

<If installed with a quick connect multi-system>

- Turn the system power ON with the remote controller.
- Slowly open a hot water fixture and check that the units ignite sequentially. Check to see that the hot water temperature is the same as the temperature displayed on the remote controller (*1)

* If both units do not ignite, switch which unit will ignite first by pressing the Max. or Min. Manifold Pressure Set Button on the circuit board. (*2)

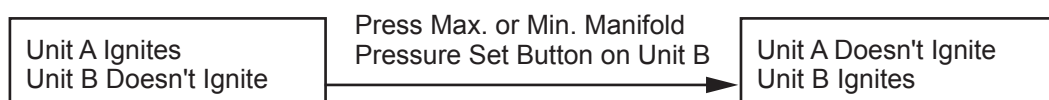

* If an 11 or F11 error code flashes on the remote controller, hit the Power Button on the remote controller off and on 2 -3 times.

* If (*1) and (*2) cannot be done, the Quick Connect Cord may not be properly connected. Check that the cord is properly connected.

CAUTION

Handling after trial operation

- If the unit will not be used immediately, close off all gas and water shutoff valves, drain all of the water out of the unit and the plumbing system to prevent the unit and system from freezing, and bleed the gas out of the gas line.
Freezing is not covered by the warranty.

WARNING

A fire or explosion may result if these instructions are not followed, which may cause loss of life, personal injury or property damage.

Lighting Instructions

This water heater does not have a pilot. It is equipped with an ignition device that automatically lights the burner.

Do not try to light the burner by hand.

1. Read the safety information in the installation manual or on the front of the water heater.
2. Turn off all electrical power to the unit.
3. Do not attempt to light the burner by hand.
4. Turn the gas control manual valve (external to the unit) clockwise to the off position.
5. Wait five minutes to clear out any gas. If the smell of gas remains, stop, and follow the instructions on page 3 of Owner's Guide.
6. Turn the gas control manual valve counterclockwise to the on position.
7. Turn on electric power to the unit.
8. The unit will now operate whenever hot water is called for. If the unit will not operate, follow the shutdown instructions and call a service technician.

Shutdown Instructions

1. Stop any water demand.
2. Turn off electric power.
3. Turn the gas control manual valve clockwise to the off position.

Should overheating occur, or the gas supply fail to shut off, turn off the manual control valve to the appliance.

14. Dimensions

< inch (mm) >

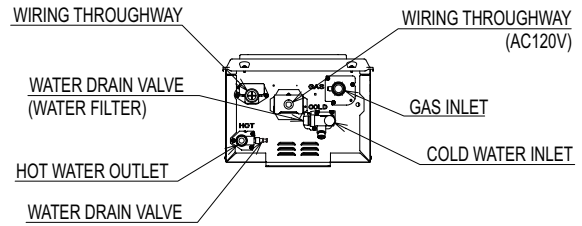
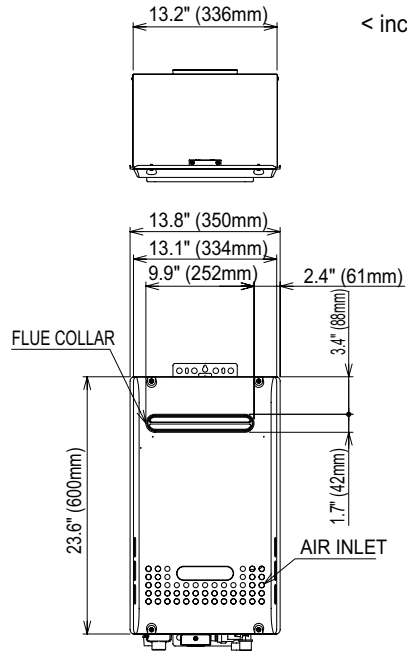
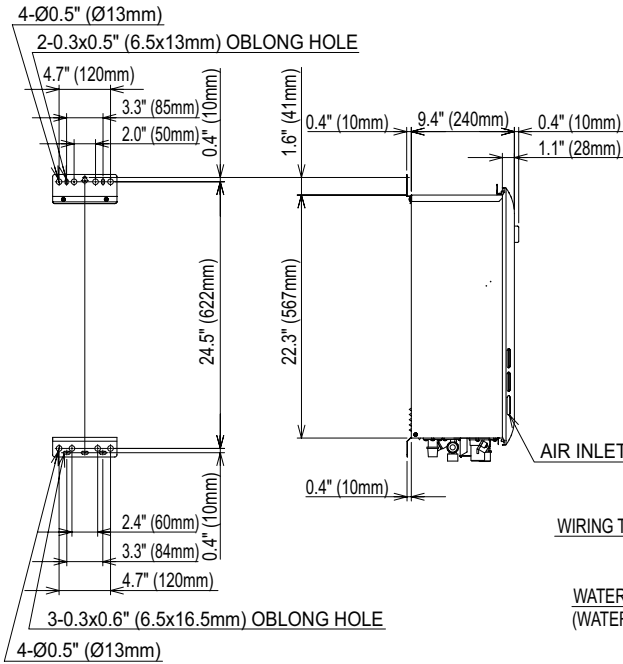

HEIGHT OF EACH FITTINGS FROM BOTTOM OF CASE

HOT WATER OUTLET	1.8" (45mm)
COLD WATER INLET	2.2" (55mm)
GAS INLET	2.2" (56mm)

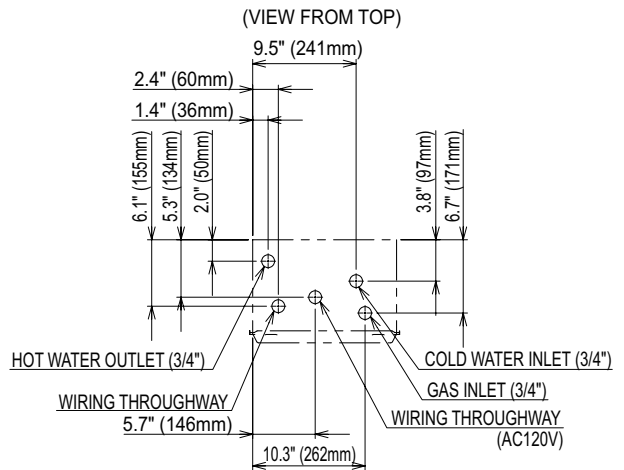

15. Multi-System

Install one system controller (SC-301-6M(-EXT)) for every six units.

Dipswitch Settings (for remote controllers RC-7647M or RC-7650M when used with system controller SC-201-6M)

Note: When this water heater is used with remote controllers RC-7646M-2, RC-7649M, or RC-9018M, it is not necessary to follow this procedure.

When using the remote controller RC-7647M or RC-7650M (°C temperature display), a dipswitch change will be necessary on all water heaters connected to the system controller. Refer to the below instructions to make the adjustment. A remote controller will need to be connected to the water heater being adjusted.

- (1) Turn the water heater off by pressing the Power On/Off Button on the remote controller.
- (2) Disconnect electrical power to the water heater, then reconnect electrical power to the water heater and wait 10 seconds before proceeding to step 3.
- (3) Within the first ten minutes of connecting electrical power, before turning on the Power On/Off Button, press the [▲] or [▼] button on the remote controller and hold until the display blinks "99". If "99" does not blink on the remote controller, unplug the water heater and try again.
- (4) Use the [▲] or [▼] button on the remote controller to scroll to the appropriate dipswitch number as indicated below.
- (5) Press the "FLOW METER ALARM SET" button for 0.5 sec to change the setting ON/OFF:
ON: "priority" lamp flashes.
OFF: "priority" lamp goes off.
- (6) Change "2F" from OFF to ON.
* Do not adjust any other dipswitches!
- (7) When the dipswitch has been set correctly, confirm the setting by pressing and holding both the [▲] and [▼] buttons on the remote controller until the controller emits a beeping noise. The new setting will be lost if this is not done.
- (8) Repeat this entire procedure for every unit that will be connected to the system controller.

* When using RC-9018M to change DIP switch, Step 5 - 7 procedures are as follows.

- (5) Press the ENTER button, "Item number" stops blinking and "Data state (OFF or ON)" will start blink. Use the [▲] or [▼] button on the remote controller to change OFF ↔ ON.
- (6) Change "2F" from OFF to ON.
* Do not adjust any other dipswitches!
- (7) When the dipswitch has been set correctly, press the ENTER button, "Data state (ON)" stops blinking and "Item number" will start blink. Confirm the setting by pressing and holding both the [▲] and [▼] buttons on the remote controller until the controller emits a beeping noise. The new setting will be lost if this is not done.

A. Installation without a recirculation system (Standard System)

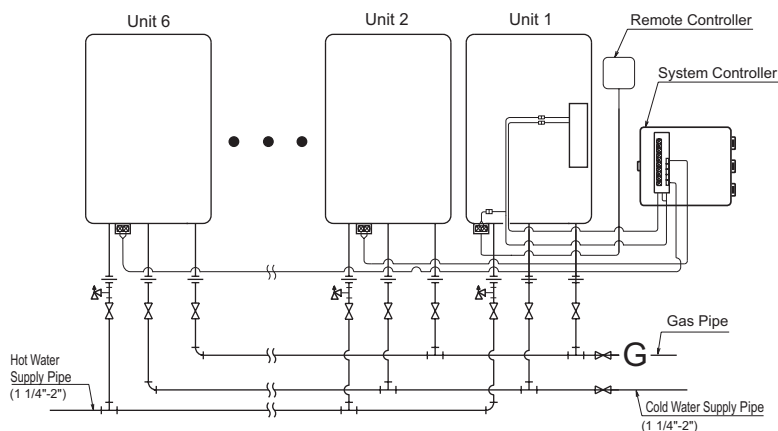

- Insulate or apply heating materials to both the cold water supply piping and the hot water supply piping to prevent freezing during cold weather and to prevent heat loss through the piping.

B-1. Example of Recirculation with a Multi-System (Recirculation system)

This system will make hot water more quickly available to remote fixtures. The pump will circulate water through the loop until the entire loop is warm, and then the system controller will turn off the pump until the loop cools down.

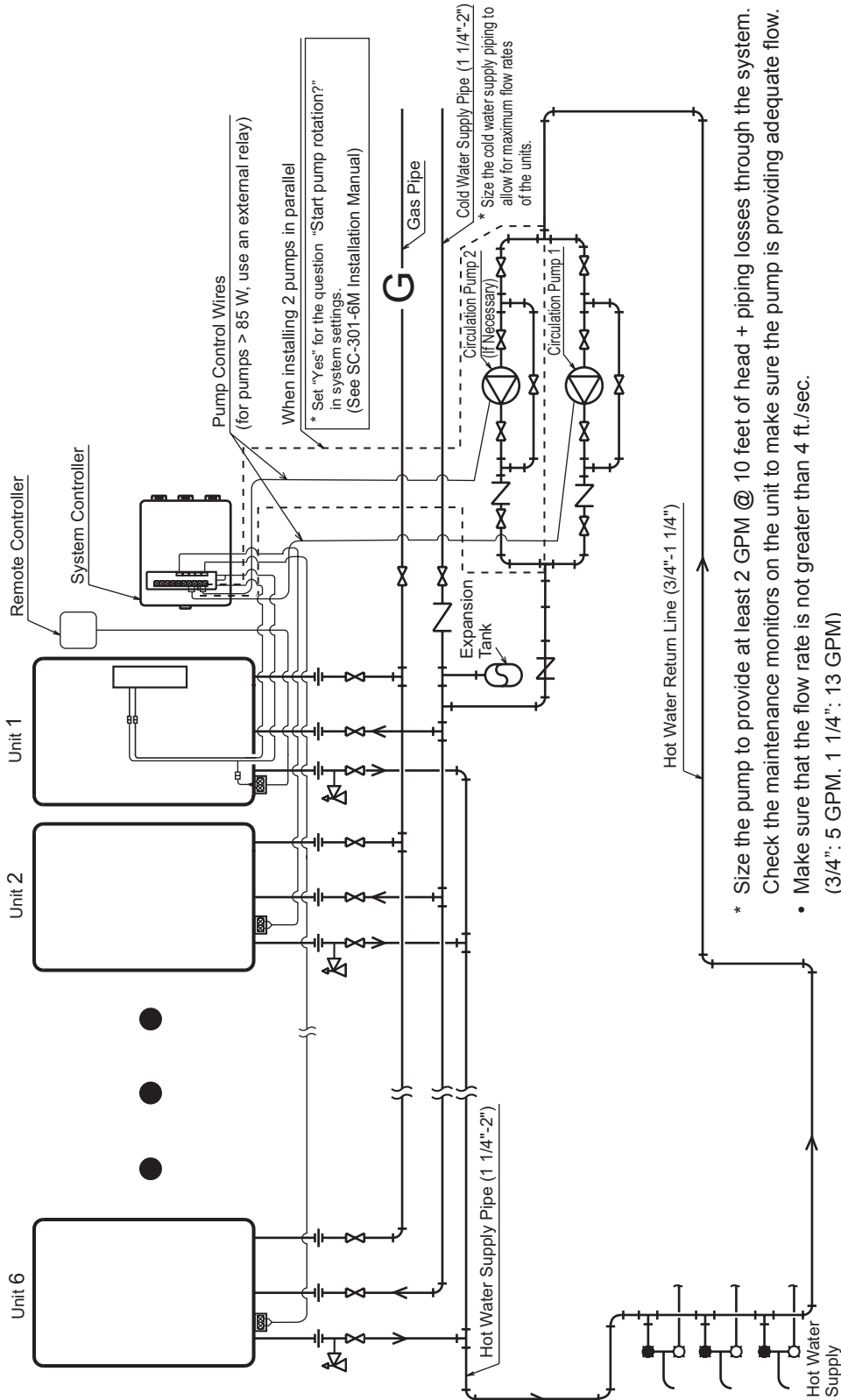

- * Size the pump to provide at least 2 GPM @ 10 feet of head + piping losses through the system. Check the maintenance monitors on the unit to make sure the pump is providing adequate flow.
- Make sure that the flow rate is not greater than 4 ft./sec. (3/4": 5 GPM, 1 1/4": 13 GPM)
- If the flow is too low, the recirculation loop temperature will not be warm enough, if the flow is too high, the lifetime of the unit will be reduced.
- * If there are multiple circulation loops, try to make the flow rate .75-1.25 GPM in each loop.
- * Use copper or stainless water piping for the entire system.

B-2. Example of Installation with a Storage Tank and Recirculation System (Tank recirculation system)

The pump will push water through the Multi-System to heat up the tank.

When the temperature of the thermostat is high, the system controller will turn off the pump until the the temperature cools down.

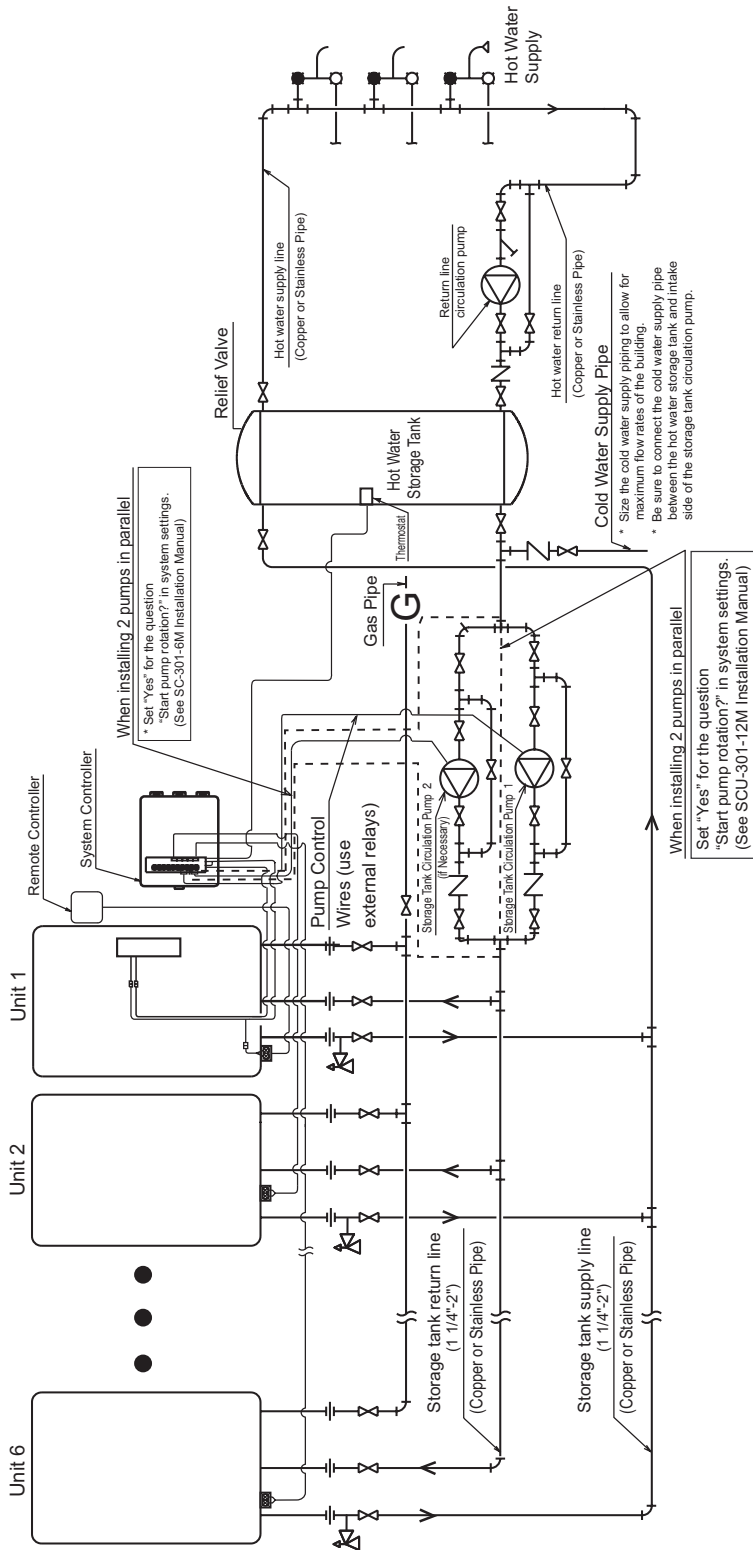

* For the set temperature of the remote controller, use the temperature (of the thermostat) + about 10°F.

* To achieve the highest recovery, size the storage tank circulation pump for maximum capacity.

(7 GPM (each) @ 35 ft. of head (160°F setting or less) + piping losses through the system.)

Verify the supply pressure to the units is at least 30 PSI.

Multi-System Wiring (Use SC-301-6M (-EXT))

* Connect these to the remote control terminal block in each unit

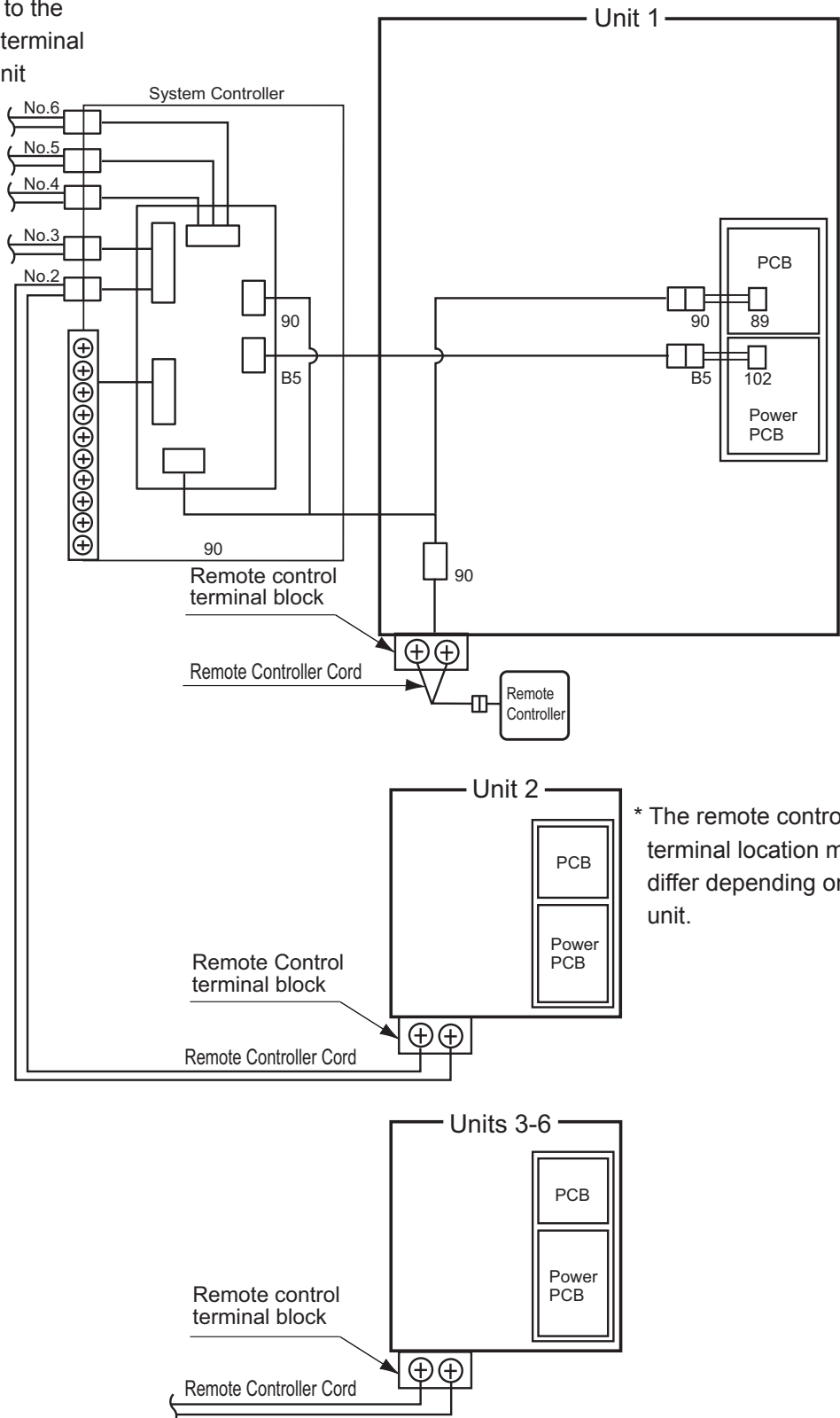

* The remote controller terminal location may differ depending on the unit.

Remote Controller
RC-9018M

Requests to Installers

- In order to use the water heater safely, read this installation guide carefully, and follow the installation instructions.
- Failures and damage caused by erroneous work or work not as instructed in this manual are not covered by the warranty.
- Refer to the Installation Manual provided with the water heater for complete installation details.

Installation Guide

NORITZ AMERICA CORPORATION

In order to use this product safely, read this installation manual carefully and follow the installation instructions.

- Potential dangers from accidents during installation and use are described below. Closely observe these warnings, they are critical to your safety.



CAUTION

CAUTION indicates a potentially hazardous situation which, if not avoided, may result in minor or moderate injury.



CAUTION

The remote controller is not water resistant. Keep it dry.



CAUTION

- Do not connect power to the system unit until the remote controller installation is complete.
- Be sure to fasten the mounting screws tightly by hand so that the remote controller will be secure.
 - * Do not use electric drivers, impact drivers and so forth. Tightening with excessive force may cause the mounting bracket to be damaged and lead to failures.
- Install the remote controller on an even wall surface.
 - * Installing it on an uneven wall surface may cause the bracket to be damaged and lead to failures.
- This remote controller has a built-in speaker which can be damaged by metal shavings resulting in sound cracking.
Keep the remote controller in a safe location prior to mounting it on the wall to prevent metal shavings from entering the remote controller.

Note

- Cutting too large of a hole on the wall may result in failure to properly secure the remote controller.
- Never fasten or loosen unnecessary screws in order to complete the remote controller installation.
- Be sure to check the positions of wall studs or other obstructions when determining the installation location for the remote controller.
- Secure the remote controller cable with appropriate anchors, ties, etc.
- Wire the remote controller cable in an area where it will not be directly affected by heat.
- To embed the remote controller cable in concrete, brick, etc., enclose it in conduit in order to prevent the remote controller cable from becoming damaged.
- When penetrating a wall containing metal lath, prevent the lath from coming into contact with any metallic conduit used in order to prevent electrical interference.
- Wiring shall be provided so that the remote controller cable length is 300 ft (90m) or shorter.
- Connect the remote controller cable to the terminal block of the water heater (see Installation Manual provided with the water heater).





Post-installation Checks

- (1) Check if the remote controller is installed securely.
 - (2) Verify remote controller operation (see Owner's Guide).
- * Press the Power On/Off button approximately 5 seconds after connecting power to the system.
 - * Check if the temperature setting on the remote controller is appropriate.

Explanation to the Customer

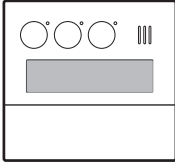
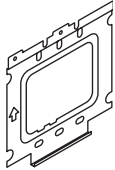
Explain the "Important Safety Information", "Operation Procedures" and "Follow-up Service" according to the Owner's Guide supplied with the water heater.

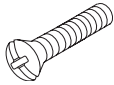
Included Parts List (The value in () indicates the quantity.)

Remote Controller	Mounting bracket	Round countersunk head wood screw	Wall anchor	Raised countersunk head screw	Machine screw
 (1)	 (1)	 (2)	 (2)	 (2) (For junction box installation)	 (2)

Notes on the Installation Location

- The remote should be installed in an easily accessible location.
- Avoid installing in a place where water or steam can come into contact with the controller.
- Avoid locations where special chemical agents (e.g., benzene, fatty and oily detergents) are used.
- Avoid outdoor installation, or installation in an indoor location where it will be exposed to direct sunlight.

Connection of Remote Controller Cord

White Connector → To Remote controller

Y-shaped terminals → To Water heater (two-core)

- * Confirm the connection with the labels at both ends of the remote controller cord.
- A 26' (8m) cord can be purchased separately (Part # RC-CORD26).
- The remote controller cord can be extended up to 300 ft (90m). by splicing the cord and using 18 gauge wire to extend the cord to the appropriate length.

Installation

1. Attach the mounting bracket to the wall.
The parts to be used vary depending on the attachment method.

* Never use electric drivers, impact drivers and so forth.
Tightening with excessive force may result in deformation of the mounting bracket and/or failures.

<When attaching to a junction box>

- Use the raised countersunk head screws to attach the mounting bracket to the junction box. (In this case, the wall anchor and round countersunk head wood screws are not used.)

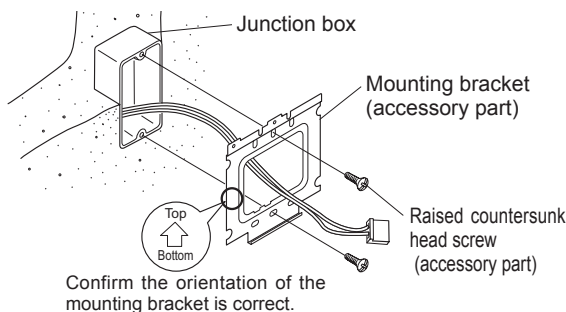

<When attaching to a wood surface>

- Use the round countersunk head wood screws to attach the mounting bracket. (In this case, the wall anchor and raised countersunk head screws are not used.)

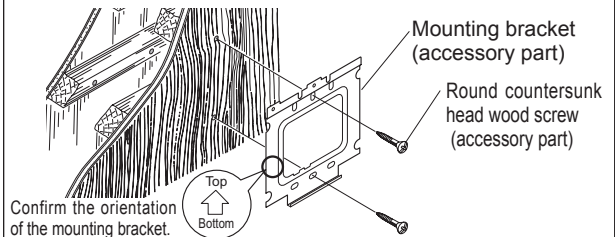

<When attaching to a concrete wall surface>

- Drill a $\phi 1/4$ " ($\phi 6\text{mm}$) hole, approx. 1" (25mm) in depth, and hammer in the wall anchor. Attach the mounting bracket using the round countersunk head wood screws. (In this case, raised countersunk head screws are not used.)

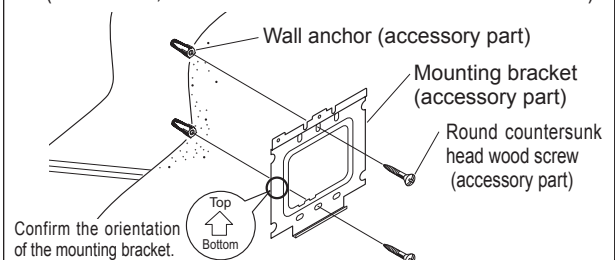

2. Remove the decorative frame from the remote controller. (The remote controller is inserted in the decorative frame.)

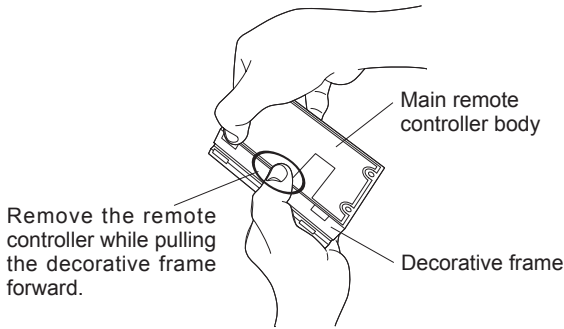

3. Connect the remote controller wires to the cord supplied with the water heater.

- * Do not remove the remote controller wires from the terminal block, connect these wires to the remote controller cord.
- * Do not remove the insulating cover (clear).
- * Some modifications are required on the frame to complete the installation. See note below.

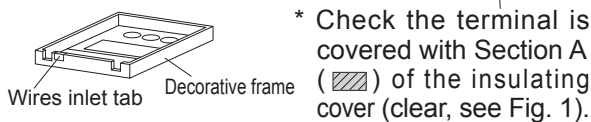
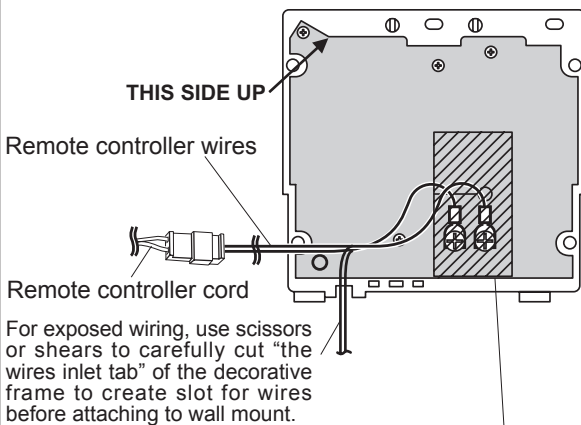

- * If the Y-shaped terminal is not covered, the exposed section may come into contact with the mounting bracket resulting in improper operation or failure.

4. Secure the remote controller wires by winding them around the notches as shown in Fig. 1.

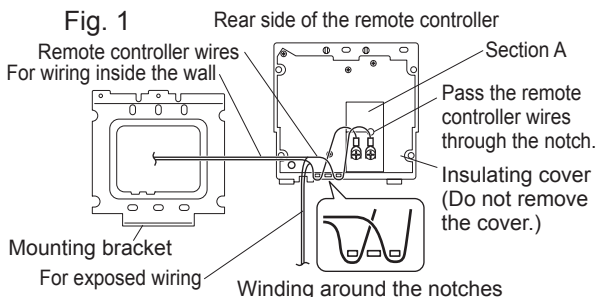

5. Attach the remote controller to the mounting bracket. Insert the bottom of the remote controller into the groove at the bottom of the bracket and push in the 2 hooks on top of the remote controller completely.

- * If it is difficult to attach, do not try to force it as it may result in broken hooks. Check for proper alignment in the groove or for loose wires obstructing the remote controller.

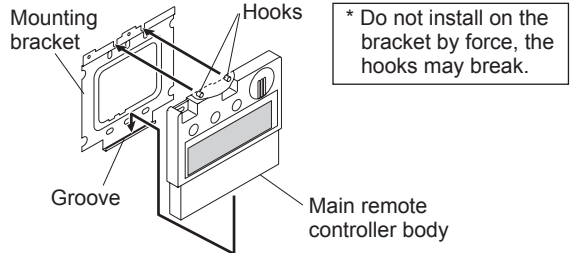

6. Secure the remote using the machine screws.

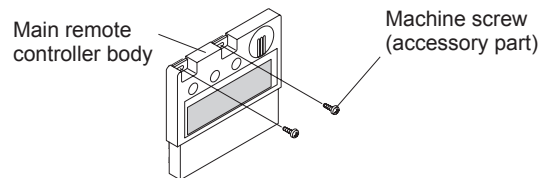

7. Attach the decorative frame which was removed in the second step. Push the 4 corners of the decorative frame until there is a click.

- * Incomplete installation may result in failures such as switch operation failure.

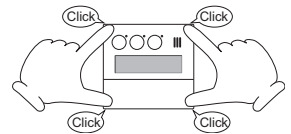

Note: To remove the decorative frame after installation of the remote controller and the frame, pull the entire decorative frame forward while pressing the sections indicated (where the fingers are) in the figure below.

- * If it does not come off, insert a flat head driver into the notch at the bottom of the decorative frame and slightly twist it to remove (due caution is required not to scratch the remote controller, decorative frame or the wall in doing so).

