

NLTH-81TW

8" Theia LED Tunable Downlight

Source: 22W

Up to 2100lm

Type

Project

Catalog No.

Notes

PRODUCT DESCRIPTION

Theia LED luminaires are commercial grade downlights designed for easy installation into new construction or remodel applications. Tunable white luminaires include an integral color temperature switch located on the junction box of each luminaire with a quick connect that allows for easy disconnect and mounting in the ceiling.

FEATURES

- Five color temperatures in each fixture (2700K / 3000K / 3500K / 4000K / 5000K)
- No housing required and includes junction box with class 2 driver
- Quick installation and cost savings
- IC Air-Tight rated
- cETLus Listed for Wet Locations
- 5-year limited warranty

SPECIFICATION

Construction: Aluminum luminaire with spring clips for easy installation. Gasket included for air-tight and wet location listing without additional caulking.

Air Flow Restriction: Luminaire has factory installed gasket to restrict airflow from room into ceiling plenum to <2CFM (cubic feet per minute) in accordance with ASTM-283 Air-Tight requirements.

Junction Box: Prewired junction box includes quick connect to LED fixtures for ease of installation. Junction box includes four 1/2" knockouts, two keyhole slots and snap on cover. Maximum of 4 No. 12 AWG or Maximum of 6 No. 14 AWG through branch circuit conductor suitable for 90°C permitted in box. [Fixture wire length: 7-1/2" and Junction box wire length: 10-1/2"]

Mounting: No housing is required, two tensions steel spring clips secure luminaires to the ceiling. Luminaires accept ceiling thicknesses from 3/8" to 1-1/4". New construction frame-in or plate are available (ordered separately), not required.

Minimum clearance: "IC" Insulated ceiling luminaires are direct contact rated; no minimum clearance is required.

ELECTRICAL

Voltage: 120VAC (blank) or 120-277VAC (LE4), must specify

Lumens / Wattage: Up to 2100lm / 22W

Color Temperature: Selectable CCT: 2700K / 3000K / 3500K / 4000K / 5000K (Note: Preset to 3000K)

Color Rendering Index: 90+ CRI

Beam Spread: 94° Wide Flood

Operating Temperature: 0°C to 35°C ambient temperature

Lifetime: 50,000 hours @ L70

Dimming: Triac/ELV (blank) or 0-10V (LE4), must specify

[Click Here](#) or check complete dimmer list at www.NoraLighting.com in the "Compatibility" page under "Resources" tab

OPTIONAL ACCESSORIES

[NF-R725:](#) New Construction Frame-In

[NFP-R725:](#) New Construction Plate

LABELS AND LISTINGS

- cETLus Listed for Wet location
- ENERGY STAR certified
- Certified to the high efficacy requirements of California Title 24 JA8-2022
- [5-Year Limited Warranty](#)
- FCC Compliant



Performance Data

Part Number	Lumens	CCT
NLTH-81TW-MPW	1920lm	2700K
NLTH-81TW-MPW	2039lm	3000K
NLTH-81TW-MPW	2112lm	3500K
NLTH-81TW-MPW	2148lm	4000K
NLTH-81TW-MPW	2082lm	5000K

PRODUCT IMAGES AND DIMENSIONS

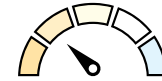

Selectable CCT

Five position sliding switch
27K / 30K / 35K / 40K / 50K



NLTH-81TW-HZMPW

Haze Reflector / Matte Powder White Flange



NLTH-81TW-MPW

Matte Powder White Reflector / Matte Powder White Flange

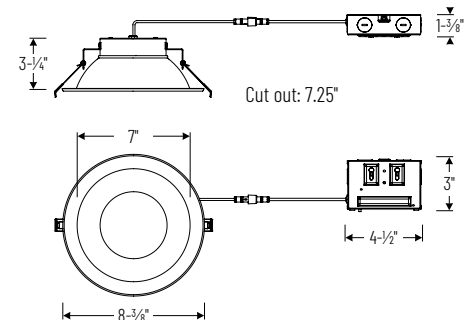

8" Theia LED Downlight with Selectable CCT

Finish	Input Voltage / Dimming
NLTH-81TW-HZMPW = Haze Reflector / Matte Powder White Flange	(blank) = 120VAC; Triac/ELV dimming
NLTH-81TW-MPW = Matte Powder White Reflector / Matte Powder White Flange	LE4 = 120-277VAC; 0-10V dimming

Optional Accessories

Description
NF-R725 = New Construction Frame-In
NFP-R725 = New Construction Plate

Example: NLTH-81TW-MPW = 8" Theia LED Downlight with Selectable CCT, Matte Powder White Finish, 120VAC input; Triac or ELV dimming

NLTH-81TW

8" Theia LED Downlight with Selectable CCT Accessories

Type _____

Project _____

Catalog No. _____

Notes _____

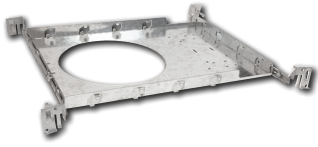

New Construction Frame-In

NF-R725

New construction frame-in can be used to assist installing can-less recessed downlighting.

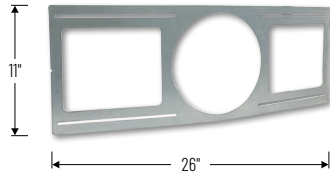

New Construction Plate

NFP-R725

New construction plate can be used to assist installing canless recessed downlighting.

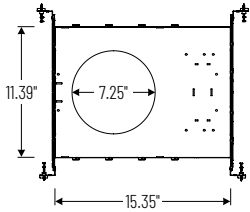

PHOTOMETRICS

8" Theia LED Tunable Downlight

Type

Project

Catalog No.

Notes

Test Information

Test Number: NTR1770R2
 Part Number: NLTH-81TW-MPW
 Beam Spread: 94° Wide Flood
 Lumens: 1920lm
 Wattage: 21.01W
 Efficacy: 91lpw
 CCT / CRI: 2700K / 90 CRI
 Spacing Criteria (0°-180°): 1.2
 Spacing Criteria (90°-270°): 1.2

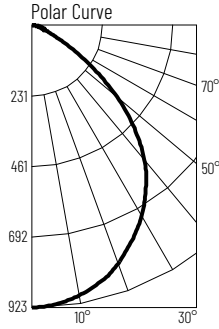

Illuminance at a Distance

Distance from Luminaire	FC at Nadir	Beam Diameter
12'	6.4fc	25'-11"
14'	4.7fc	30'-4"
16'	3.6fc	34'-7"
18'	2.9fc	38'-11"
20'	2.3fc	43'-2"

Zonal Lumen Summary

Zone	Lumens	% Luminaire
0-30	695	36.2
0-40	1113	58
0-60	1759	91.6
0-90	1920	100
90-180	0	0
0-180	1920	100

Candela Table

Vertical Angles	Candela
0	923
5	914
15	875
25	795
35	673
45	511

Test Information

Test Number: NTR1771R2
 Part Number: NLTH-81TW-MPW
 Beam Spread: 94° Wide Flood
 Lumens: 2039lm
 Wattage: 20.64W
 Efficacy: 99lpw
 CCT / CRI: 3000K / 90 CRI
 Spacing Criteria (0°-180°): 1.2
 Spacing Criteria (90°-270°): 1.2

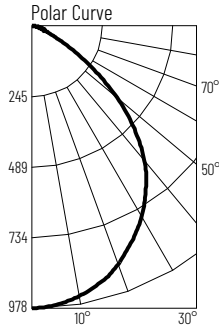

Illuminance at a Distance

Distance from Luminaire	FC at Nadir	Beam Diameter
12'	6.8fc	26'
14'	5fc	30'-4"
16'	3.8fc	34'-7"
18'	3fc	38'-11"
20'	2.5fc	43'-4"

Zonal Lumen Summary

Zone	Lumens	% Luminaire
0-30	738	36.2
0-40	1183	58
0-60	1869	91.7
0-90	2039	100
90-180	0	0
0-180	2039	100

Candela Table

Vertical Angles	Candela
0	978
5	974
15	930
25	843
35	716
45	541

Test Information

Test Number: NTR1772R2
 Part Number: NLTH-81TW-MPW
 Beam Spread: 94° Wide Flood
 Lumens: 2112lm
 Wattage: 20.19W
 Efficacy: 105lpw
 CCT / CRI: 3500K / 90 CRI
 Spacing Criteria (0°-180°): 1.2
 Spacing Criteria (90°-270°): 1.2

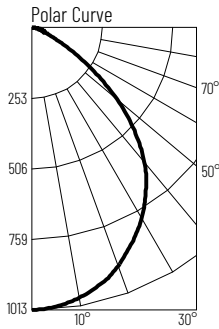

Illuminance at a Distance

Distance from Luminaire	FC at Nadir	Beam Diameter
12'	7fc	26'
14'	5.2fc	30'-5"
16'	4fc	34'-8"
18'	3.1fc	39'
20'	2.5fc	43'-5"

Zonal Lumen Summary

Zone	Lumens	% Luminaire
0-30	764	36.2
0-40	1224	58
0-60	1935	91.6
0-90	2112	100
90-180	0	0
0-180	2112	100

Candela Table

Vertical Angles	Candela
0	1013
5	1007
15	960
25	874
35	743
45	561

Test Information

Test Number: NTR1773R2
 Part Number: NLTH-81TW-MPW
 Beam Spread: 94° Wide Flood
 Lumens: 2148lm
 Wattage: 20.54W
 Efficacy: 105lpw
 CCT / CRI: 4000K / 90 CRI
 Spacing Criteria (0°-180°): 1.2
 Spacing Criteria (90°-270°): 1.2

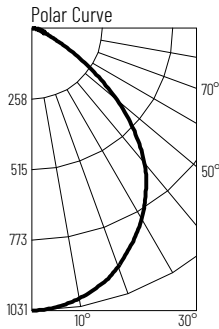

Illuminance at a Distance

Distance from Luminaire	FC at Nadir	Beam Diameter
12'	7.2fc	26'
14'	5.3fc	30'-4"
16'	4fc	34'-7"
18'	3.2fc	38'-11"
20'	2.6fc	43'-4"

Zonal Lumen Summary

Zone	Lumens	% Luminaire
0-30	645	30
0-40	1056	49
0-60	1937	90.2
0-90	2148	100
90-180	0	0
0-180	2148	100

Candela Table

Vertical Angles	Candela
0	1031
5	1025
15	977
25	886
35	754
45	569

Test Information

Test Number: NTR1774R2
 Part Number: NLTH-81TW-MPW
 Beam Spread: 94° Wide Flood
 Lumens: 2082lm
 Wattage: 21W
 Efficacy: 99lpw
 CCT / CRI: 5000K / 90 CRI
 Spacing Criteria (0°-180°): 1.2
 Spacing Criteria (90°-270°): 1.2

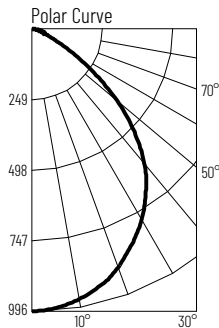

Illuminance at a Distance

Distance from Luminaire	FC at Nadir	Beam Diameter
12'	6.9fc	26'
14'	5.1fc	30'-4"
16'	3.9fc	34'-7"
18'	3.1fc	39'
20'	2.5fc	43'-4"

Zonal Lumen Summary

Zone	Lumens	% Luminaire
0-30	752	36.1
0-40	1205	57.9
0-60	1906	91.5
0-90	2082	100
90-180	0	0
0-180	2082	100

Candela Table

Vertical Angles	Candela
0	996
5	991
15	946
25	863
35	730
45	552