

NSIC-4LMRAT

4" Max. Adjustability LED Dedicated IC Air-Tight New Construction Housing

Source: 12W max.

(Compatible with Pearl Series)

Type

Project

Catalog No.

Notes

PRODUCT DESCRIPTION

Dedicated new construction housing for use in insulated ceilings can be in direct contact with insulation.* Air-tight construction provides energy savings by reducing the flow of air through the ceiling. The housing is dedicated and labeled for use with Pearl LED Series to allow maximum adjustability for adjustable reflectors. Housing does not include a "can" inside, allow for adjustable reflectors to adjust up to 35°.

FEATURES

- Allows adjustable reflectors the maximum angle or rotation and tilt
- IC Air-Tight energy saving by reducing the flow of air through the ceiling
- Rated for direct contact with insulation
- cULus listed for damp location (wet location when used with compatible reflectors)
- 24-1/2" Bar hangers with captive nails and alignment foot

CONSTRUCTION

Housing: 0.040 steel frame with integral bar hanger brackets. Ceiling collar accommodates ceiling thickness from 1/2" to 7/8", optional 1.75" ceiling extension collar available (NSIC-4EXTC2).

Air Flow Restriction: Housing has factory installed gaskets to restrict airflow from room into ceiling plenum to <2CFM (cubic feet per minute) in accordance with ASTM-283 Air-Tight requirements.

Clearance: "IC" Insulated ceiling housings are direct contact rated. **Not to be used in direct contact with spray foam insulation.**

Bar Hangers: Two 13-3/4" to 24-1/2" adjustable bar hangers with captive nails are included on frame. Hanger bars have T-Bar slot and alignment feet. Bar hangers are parallel to junction box, but can be repositioned 90° perpendicular to junction box if desired. "L" Shaped bar hanger foot to align to bottom of construction joist. A T-Bar notch allows easy installation in a suspended ceiling.

Junction Box: Prewired 25 cubic inch 0.060" thick galvanized steel with seven 1/2" trade size knockouts, four Romex® pryouts, and snap on covers. All leads are #18AWG wire, the ground wire is connected to the bottom, and quick connectors are supplied on all leads. Through branch circuit wiring, (4-in, 4-out).

ELECTRICAL







Input Voltage: 120V

Socket: Quick connect for LED reflectors

Wattage: 12W max.

Dimming: Triac or ELV

COMPATIBLE REFLECTORS

CATALOG NO.	DESCRIPTION
NPR-4RC	4" Pearl Round Adjustable Cone
NPR-4RG	4" Pearl Round Adjustable Gimbal
NPR-4RPH 	4" Pearl Round Fixed Pinhole (Wet Location)
NPR-4RPHA 	4" Pearl Round Adjustable Pinhole
NPR-4RNB 	4" Pearl Round Bullnose (Wet Location)
NPR-4RND 	4" Pearl Round Reflector with Round Aperture (Wet Location)
NPR-4RSL	4" Pearl Round Adjustable Slot Aperture
NPR-4SC	4" Pearl Square Adjustable Cone
NPR-4SG	4" Pearl Square Adjustable Gimbal
NPR-4SNB 	4" Pearl Square Bullnose (Wet Location)
NPR-4SND 	4" Pearl Square Reflector with Round Aperture (Wet Location)
NPR-4SND 	4" Pearl Square Reflector with Square Aperture (Wet Location)

LABELS AND LISTINGS

- cULus Listed for Damp Location (Wet Location when used with compatible reflectors)
- Meets or exceeds ASTM-283 Air-Tight requirements
- Can be used to comply with high efficacy requirements of California Title 24 JA8-2019 when used with compatible reflector



PRODUCT IMAGES & DIMENSIONS

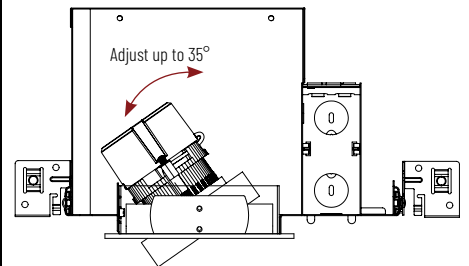
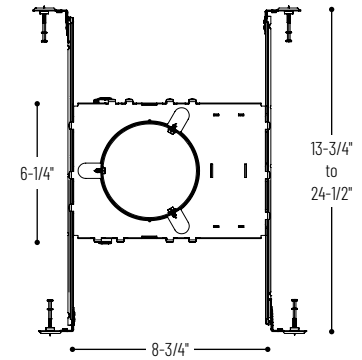
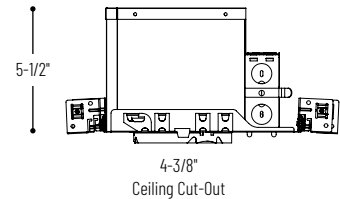
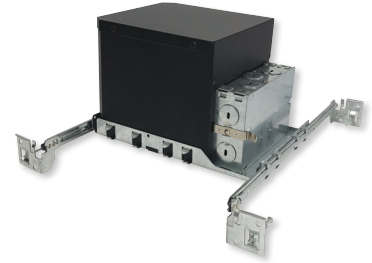

NSIC-4EXTC2

4" Max. Adjustability LED Dedicated IC Air-Tight New Construction Housing

Optional Accessories

Housing Type
NSIC-4LMRAT: 4" Max. Adjustability LED Dedicated IC Air-Tight Housing

Description
NSIC-4EXTC2 = Ceiling Extension Collar up to 1.75"

Example: NSIC-4LMRAT = 4" Max. Adjustability LED Dedicated IC Air-Tight New Construction Housing