

User's Information Manual

NCB-E Condensing Combi-Boilers

Getting Service

If your boiler requires service, you have several options for getting service:

- Contact Technical Support at 1-800-519-8794 or on the website: www.navien.com.
- For warranty service, always contact Technical Support first.
- Contact the technician or professional who installed your boiler.
- Contact a licensed professional for the affected system (for example, a plumber or electrician).

When you contact Technical Support, please have the following information at hand:

- Model number
- Serial number
- Date purchased
- Installation location and type
- Error code, if any appears on the front panel display

Version : 5.0 (Aug 30, 2015)



Navien, Inc.
800.519.8794 | www.Navien.com
20 Goodyear Irvine, CA 92618

User's Information Manual

NCB-E Condensing Combi-Boilers

Model | NCB-150E
NCB-180E
NCB-210E
NCB-240E



Keep this manual near this boiler for future reference whenever maintenance or service is required.

* The wetted surface of this product contacted by consumable water contains less than one quarter of one percent (0.25%) of lead by weight.



WARNING

If the information in these instructions is not followed exactly, a fire or explosion may result, causing property damage, personal injury or death.

Do not store or use gasoline or other flammable vapors and liquids in the vicinity of this or any other appliance.

What to do if you smell gas

- Do not try to light any appliance.
- Do not touch any electrical switch; do not use any phone in your building.
- Immediately call your gas supplier from a neighbor's phone. Follow the gas supplier's instructions.
- If you cannot reach your gas supplier, call the fire department.

Installation and service must be performed by a qualified installer, service agency or the gas supplier.

The installation must conform with local codes or, in the absence of local codes, the National Fuel Gas Code, ANSI Z223.1/NFPA 54 and/or CSA B149.1, Natural Gas and Propane Installation Code.

Contents

1. Safety Information	3
2. About the Boiler	6
2.1 Description of the Boiler	6
2.2 Parts of the Boiler	6
2.3 The Front Panel	7
3. Operating the Boiler	9
3.1 Turning the Boiler On or Off	9
3.2 Adjusting the Temperature	9
3.3 Viewing Basic Information	10
3.4 Resetting the Boiler	11
4. Maintaining the Boiler	12
4.1 Cleaning the Boiler	12
4.2 Draining the Boiler	12
4.3 Cleaning the Inlet Water Filter (DHW side)	13
4.4 Cleaning the Strainer (Space Heating side)	14
4.5 Cleaning the Air Intake Filter	14
4.6 Protecting the Boiler from Freezing	16
4.7 Maintenance Schedules	17
5. Troubleshooting	21
5.1 Solving Basic Problems	21
5.2 Understanding Error Codes	22

1. Safety Information

The following safety symbols are used in this manual. Read and follow all safety instructions in this manual precisely to avoid unsafe operating conditions, fire, explosion, property damage, personal injury, or death. Keep this manual for future reference.



DANGER

Indicates an imminently hazardous situation which, if not avoided, could result in severe injury or death.



WARNING

Indicates a potentially hazardous situation which, if not avoided, may result in injury or death.



CAUTION

Indicates a potentially hazardous situation which, if not avoided, could result in property damage.



WARNING

If you do not follow these instructions exactly, a fire or explosion may result causing property damage, personal injury or loss of life.

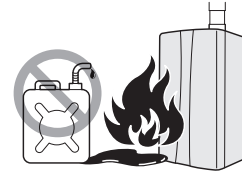

- A. This appliance does not have a pilot. It is equipped with an ignition device which automatically lights the burner. Do not try to light the burner by hand.
- B. BEFORE OPERATING smell all around the appliance area for gas. Be sure to smell next to the floor because some gas is heavier than air and will settle on the floor.

WHAT TO DO IF YOU SMELL GAS

- Do not try to light any appliance.
 - Do not touch any electric switch; do not use any phone in your building.
 - Immediately call your gas supplier from a neighbor's phone. Follow the gas supplier's instructions.
 - If you cannot reach your gas supplier, call the fire department.
 - Do not return to your home until authorized by your gas supplier or the fire department.
- C. Use only your hand to push in or turn the gas control knob. Never use tools. If the knob will not push in or turn by hand, don't try to repair it, call a qualified service technician. Force or attempted repair may result in a fire or explosion.
 - D. Do not use this appliance if any part has been under water. Immediately call a qualified service technician to inspect the appliance and to replace any part of the control system and any gas control which has been under water.

! DANGER



To prevent burns:

- Use the lowest operating temperature setting necessary to provide comfortably-hot water.
- If your household has children or elderly or disabled residents, consider using a lower temperature setting.
- Read all the instructions in this manual carefully before changing the temperature setting.
- Feel the water before using it on children, the elderly, or the disabled.
- If it is necessary to set the water temperature above 125°F (52°C), consider installing a thermostatically-controlled mixing valve or temperature-limiting valve. Contact a licensed plumber or your local plumbing authority for more information.

! DANGER

This boiler's water temperature is set to 120°F (49°C) at the factory for your safety and comfort. Increasing the temperature increases the risk of accidental scalding. Water temperatures at or above 125°F (52°C) can cause instant scalding, severe burns, or death. Before you decide to change the temperature setting, read the following charts carefully.

Water Temperature	Time in which a young child can suffer a full thickness (3rd degree) burn
160°F (70°C)	Less than 1 second
140°F (60°C)	1 second
130°F (55°C)	10 seconds
120°F (49°C)	10 minutes
100°F (37°C)	very low scald risk

 **WARNING**

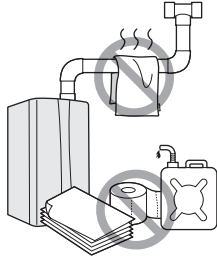

- **Shut off the gas supply if the boiler is damaged.**
Have your installer or plumber show you the location of the gas shut off valve and demonstrate how to close the valve. If the boiler is damaged as a result of overheating, fire, flood, or any other reason, close the manual shut off valve and do not operate the boiler again until it has been inspected by a qualified technician.
- **Do not store or use gasoline or other flammable liquids near this boiler.**
Doing so may result in fire or explosion.
- **Do not place combustibles, such as newspapers or laundry, near the boiler or venting system.**
Doing so may result in a fire.
- **Do not place or use hair sprays, spray paints, or any other compressed gases near the boiler or venting system, including the vent termination.**
Doing so may result in fire or explosion.
- **Do not operate the boiler with the front cover opened.**
Doing so may result in fire or carbon monoxide (CO) poisoning, which may result in property damage, personal injury, or death.
- **Do not operate this boiler without proper venting.**
Doing so may result in fire or carbon monoxide (CO) poisoning, which may result in property damage, personal injury, or death. Inspect the vent termination and air intake supply annually to ensure proper operation of the boiler. Turn off and discontinue use of the boiler if any of the vent pipes, vent elbows, or intake pipes are damaged in any way, separated at a joint, or show evidence of corrosion, rusting, or melting.
- **Do not touch the power cord or internal components of the boiler with wet hands.**
Doing so may result in electric shock.
- **Do not make any electrical connections before turning off the electrical power supply at service entrance panel.**
Doing so may result in severe personal injury or death.

 **CAUTION**

- **Do not attempt to repair or replace any part of the boiler, unless it is specifically recommended in this manual.**
For all other service, contact an authorized technician or licensed professional. Improper adjustments, alterations, service, or maintenance may lead to property damage, personal injury, or death and will void your warranty.
- **Do not operate the boiler if you feel something is wrong with it.**
Doing so may result in product damage or personal injury.
- **Do not allow children to operate or access the boiler.**
Doing so may result in product damage or personal injury.
- **Do not attempt to change the DHW water temperature while the boiler is being used.**
Doing so may result in personal injury.
- **Do not turn on the boiler unless the water and gas supplies are fully opened.**
Doing so may damage the boiler.
- **Do not turn on the water if the cold water supply shut-off valve is closed.**
Doing so may damage the boiler.
- **Do not use this boiler for anything other than its intended purpose, as described in this manual.**
- **Do not remove the front cover unless the power to the boiler is turned off or disconnected.**
Failure to do so may result in electric shock.
- **When servicing the controls, label all wires prior to disconnecting them.**
Failure to do so may result in wiring errors, which can lead to improper or dangerous operation.
- **Do not use unapproved replacement or accessory parts.**
Doing so may result in improper or dangerous operation and will void the manufacturer's warranty.
- **Do not place anything in or around the vent terminals, such as a clothes line, that could obstruct the air flow in or out of the boiler.**
- **This boiler has been approved for use in the USA and Canada only.**
Using the boiler in any other country will void the manufacturer's warranty.
- **Should overheating occur or the gas supply fail to shut off, turn off the manual gas valve to the appliance.**

2. About the Boiler

2.1 Description of the Boiler

The Navien NCB-E boiler is available in 4 models: NCB-150E, NCB-180E, NCB-210E, and NCB-240E.

The main features are as follows:

- **Power Interruption:** When the power is restored after a power failure, the boiler will automatically start and return to normal operation. A manual reset is not required.
- **Automatic Water Fill:** Should the water level in the system fall too low, a sensor will automatically activate the refill circuit.
- **Freeze Protection:** A sensor inside the boiler automatically detects the temperature and, if necessary, initiates a safety heating cycle to prevent internal equipment damage due to freezing temperatures.
- **Short-Circuit Protection:** Any short-circuit occurring in the boiler's electrical circuit immediately blows the internal glass fuses and automatically cuts off the gas supply.
- **Lightning Protection:** Each boiler is specially grounded, both internally and externally, to protect against lightning strikes.
- **Carbon Monoxide Protection:** The boiler is designed to maintain a safe air-to-gas ratio and combustion rate. This function is continuously monitored by the boiler's air ratio control module.
- **Thermostat Control Failure:** Should the thermostat fail to function properly, the boiler's gas supply will be shut off automatically as a safeguard.
- **Auto Fan Detection:** The rotation of the fan is automatically detected and controlled. Fan failure will stop the operation of the boiler.
- **Boiling Prevention:** Excessive temperatures will automatically stop the boiler.

2.2 Parts of the Boiler

Front View

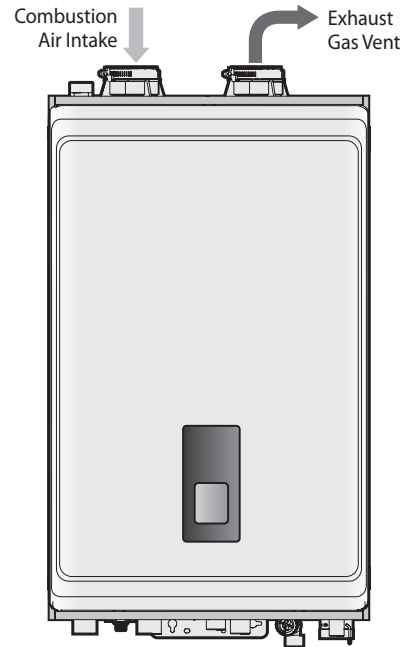

Bottom View

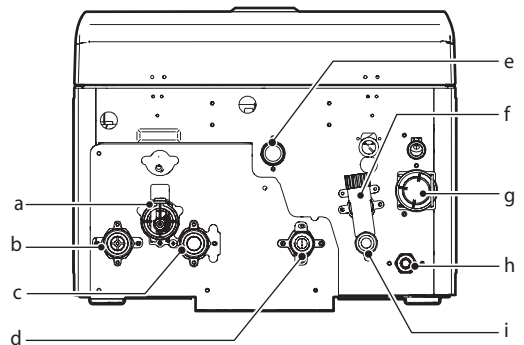

#	Description
a	Space Heating Strainer (Pump Drain Plug)
b	Space Heating Supply Connection
c	Space Heating Return Connection
d	DHW Hot Water Outlet Connection
e	Gas Connection
f	Cold Water Inlet Filter
g	Condensate Water Outlet
h	Auto Feeder Connection
i	Cold Water Inlet Connection

2.3 The Front Panel

The front panel allows you to adjust the temperature and view the operating status or error codes. Remove the protective sheet from the front panel before using it.

2.3.1 Icons and Digital Display

The icons and digital display on the front panel provide important information required for the boiler's operation. Refer to the following table for detailed information.



a  **Space heating mode**

Indicates space heating mode operation.

b  **Error**

A code will appear on the display.

c  **Combusting**

Indicates burner operation.

d  **DHW mode**

Indicates DHW mode operation.

e  **Digital Display**

f  **Supply water control**

Indicates supply water control status.

g  **Return water control**

Indicates return water control status.

h  **Outdoor Reset**

Indicates outdoor reset operation.

i  **GPM**

Indicates water flow.

j  **Psi**

Indicates water pressure.

2.3.2 Buttons

Using the buttons on the front panel, you can turn on or off the boiler, monitor the current operation status, and set the values required for the boiler's operation, such as space heating and DHW supply temperatures. Refer to the following table for detailed information.

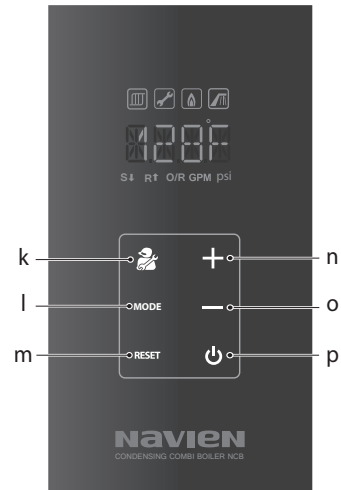

k  **Diagnostics button**

For installers only

l  **Mode button**

Changes the mode.

m  **Reset button**

Resets the boiler (When an error occurs).

n  **Up button**

Increases the temperature.

o  **Down button**

Decreases the temperature.

p  **Power button**

Turns the boiler on or off.

3. Operating the Boiler

3.1 Turning the Boiler On or Off

To turn the boiler on or off, press the Power button for 0.3 seconds.

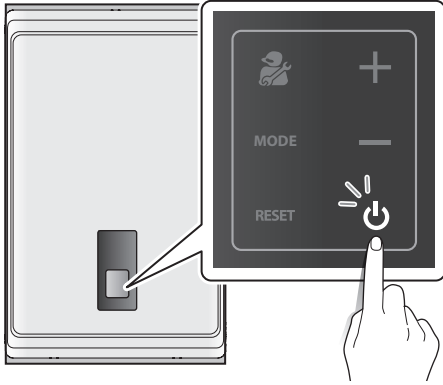

When the power is on, the boiler supply water temperature will appear with the water pressure on the front panel display in 5 second intervals.

Note

- If the Air purge is operating, "Air" will appear with the water pressure on the front panel display in 5 second intervals.
- When displaying the boiler supply water temperature, the supply or return water icon flashes, depending on the space heating control mode.

2. Press the + (Up) or – (Down) buttons until the desired temperature appears on the display.

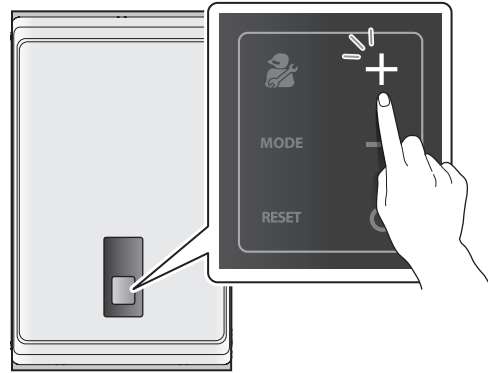

You can adjust the temperature while the display is flashing. Once the display stops flashing, the temperature setting is stored.

Note

- Take note of the original heating temperature in case you want to restore it to the default.
- The default space heating supply water temperature range is 104°F (40°C, Absolute MIN) to 180°F (82°C, Absolute MAX).
- The default space heating return water temperature range is 86°F (30°C, Absolute MIN) to 149°F (65°C, Absolute MAX).
- You can adjust the temperature range in the parameter settings menu.
- The boiler will retain your settings during a power outage.

3.2 Adjusting the Temperature

3.2.1 Adjusting the Space Heating Temperature

To adjust the heating temperature:

1. Press the Mode button once. The space heating icon turns on.

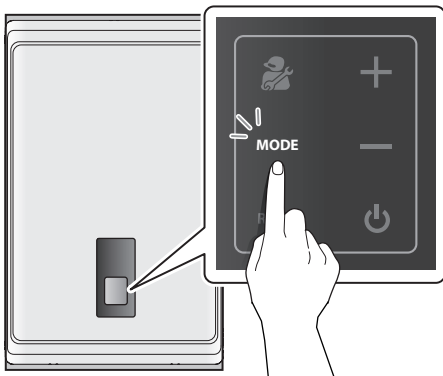

3.2.2 Adjusting the DHW Water Temperature

WARNING

Before adjusting the water temperature, read “To prevent burns:” on page 4 carefully. Water above 120°F can cause instant scalding, severe burns, or death.

To adjust the water temperature:

1. Make sure that all hot water faucets are closed, and ensure that the internal circulator and any external circulating pumps are off.
2. Press the Mode button twice. The DHW mode icon turns on.
3. Press + (Up) or – (Down) buttons until the desired temperature appears on the display.

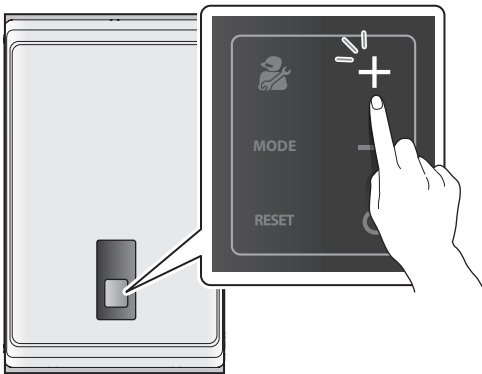

You can adjust the temperature while the display is flashing. Once the display stops flashing, the temperature setting is stored.

Temperature range	Adjusting the water temperature
86-120°F (Fahrenheit mode) 30-50 °C (Celsius mode)	1°F or 1°C increments
120-140°F (Fahrenheit mode) 50-60 °C (Celsius mode)	Press for 2 seconds to adjust in 5°F or 2°C increments





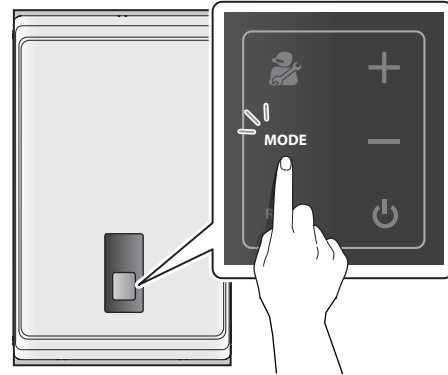

Note The boiler will retain your settings during a power outage.



3.3 Viewing Basic Information

To view information about the boiler, press the Mode button three times. “INFO” will appear on the display.



Press the + or – buttons to switch between the information types.

Display	Description
	Space heating supply water temperature (°F)
	Space heating return water temperature (°F)
	Domestic hot water outlet temperature (°F)
	Cold water inlet temperature (°F)
	Domestic Hot Water (DHW) Flow rate in GPM
	Outdoor air temperature (°F) (with optional Outdoor Temperature Sensor only)

Display	Description
	Outdoor reset curve -: Not in use. 1: Finned tube baseboard 2: FAN coil 3: Cast iron baseboard 4: Low mass radiant 5: High mass radiant 6: Radiator 7: Custom (set by installer)
	Boost interval time (set by installer)
	Space heating water pressure in PSI

To exit the Information mode, press the Reset button.

3.4 Resetting the Boiler

If an error message appears, you can try resetting the boiler to resolve the problem. To reset the boiler, press the Reset button.

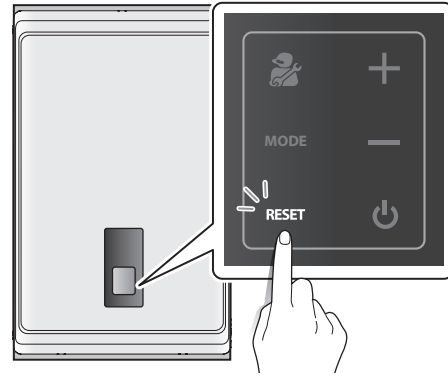

If resetting the boiler does not solve the problem, refer to the Troubleshooting section of this manual or contact Technical Support at 1-800-519-8794.

4. Maintaining the Boiler

4.1 Cleaning the Boiler

! CAUTION

Make sure the boiler is turned off and the power supply is disconnected before cleaning the boiler. The boiler may remain hot for several minutes after it is turned off. To prevent burns, wait until the boiler has cooled down before cleaning.

To clean the boiler, wipe the outside with a damp cloth. Use a non-acidic, non-abrasive cleaner to remove any surface stains. The front panel is moisture resistant, but it is not waterproof. Keep it as dry as possible.

4.2 Draining the Boiler

You will need to drain either both the space heating side and domestic hot water (DHW) side, or one side only before performing maintenance tasks, such as cleaning the inlet water filter, or to prevent the boiler from freezing when it will not be used for an extended period.

Refer to the “2.2 Parts of the Boiler” on page 6 for details about part locations.

To drain the boiler:

1. Place a bucket under the boiler, to collect the residual water inside the boiler.
2. Press the Power button on the front panel to turn off the boiler.

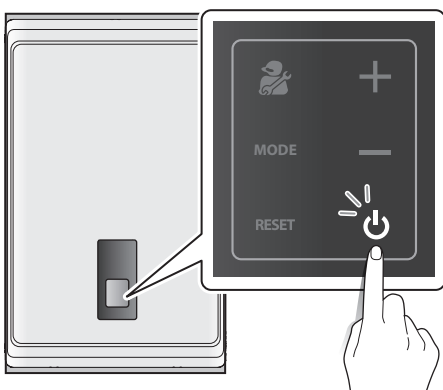

3. Close the gas valve.

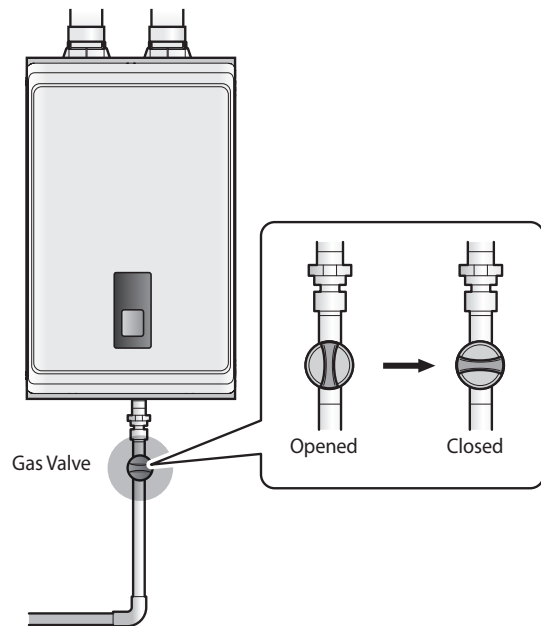

4. Close the water supply valve on the inlet to the boiler. If there is no valve, turn off the water supply at the water main.

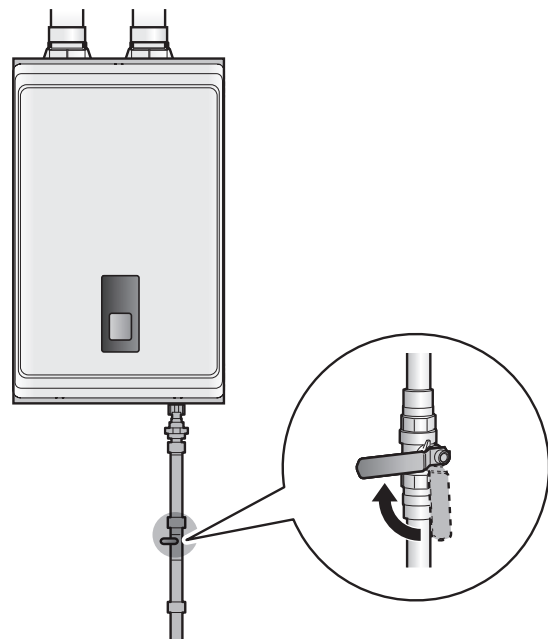

- Close off any heating zones that do not require draining and open a purge valve to drain the space heating side. Open all domestic hot water faucets completely to drain the water heating side. The water that remains in the plumbing lines will drain out.

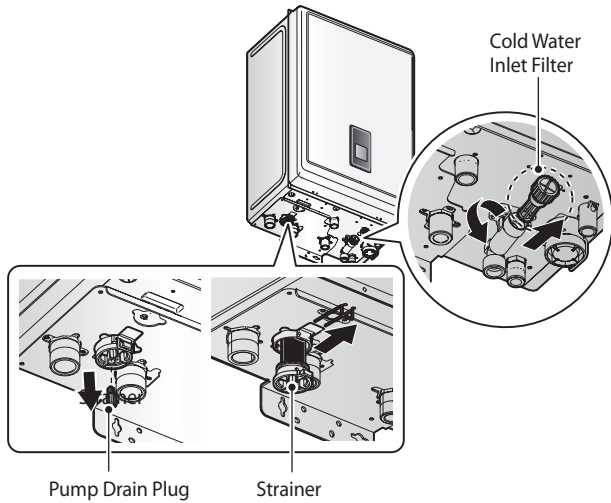

- Open the pump drain plug.
- Remove the strainer from the bottom of the boiler.
- Remove the cold water inlet filter.
- Allow the residual water to drain from the boiler.
- When the water is completely drained, reinsert the cold water inlet filter and close the pump drain plug.
- To refill the boiler follow the steps of "Draining the Boiler" in reverse.

4.3 Cleaning the Inlet Water Filter (DHW side)

To clean the filter:

- Drain the DHW side of the boiler. Refer to "4.2 Draining the Boiler" on page 12.
- While the filter is removed, rinse it with clean running water (cold) and, if necessary, scrub it clean with a brush.

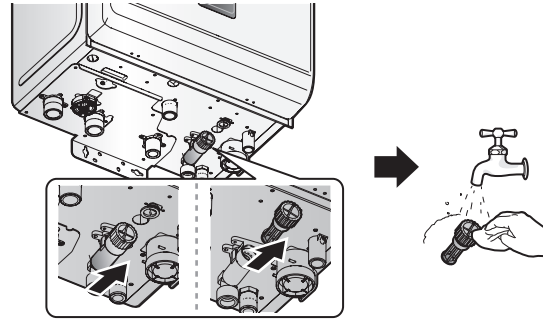

- Reinsert and tighten the filter.
- Fill the boiler and check for proper operation.

4.4 Cleaning the Strainer (Space Heating side)

If the heating performance is decreased, you can increase the heating performance by filtering impurities from the system.

To clean the strainer:

1. Drain the space heating side of the boiler. Refer to “4.2 Draining the Boiler” on page 12.
2. Remove the clip and then remove the strainer.
3. While the strainer is removed, rinse it with clean running water (cold).

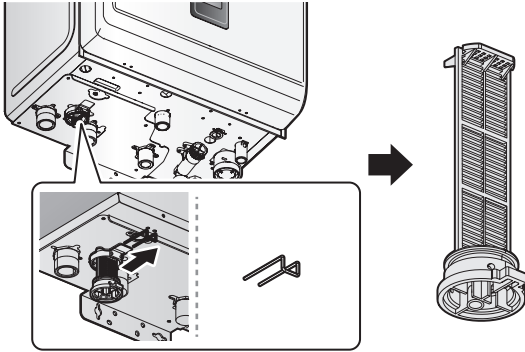

4. Reinsert and tighten the strainer.
5. Fill the boiler and check for proper operation.

4.5 Cleaning the Air Intake Filter

If the air intake filter becomes clogged by dust or lint, the boiler will cease to operate and “Error Code 110” will appear on the front panel display. To properly maintain the boiler, you should clean the air intake filter every 3-4 months.

To clean the air intake filter:

1. Press the Power button on the front panel to turn off the boiler.

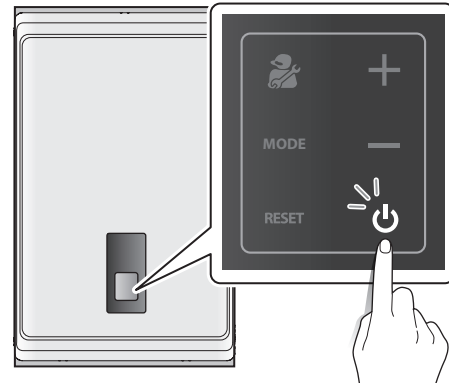

2. Disconnect the power supply to the boiler.
3. Unclasp the 3 buckles that fix the cover to the boiler, and then remove the cover by lifting it and pulling it outward.

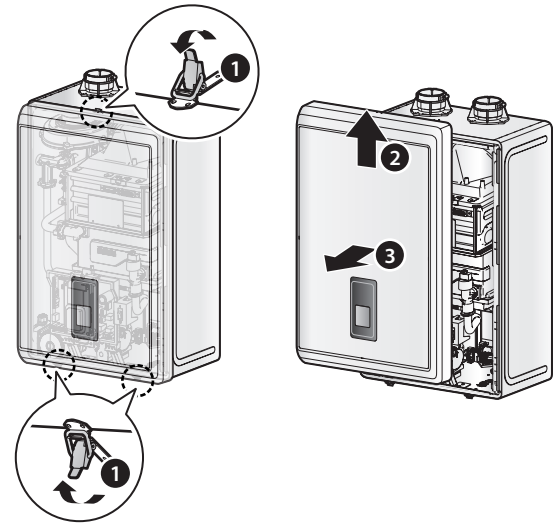

4. Remove the screw that secures the air intake filter (the filter is located at the top left of the boiler).

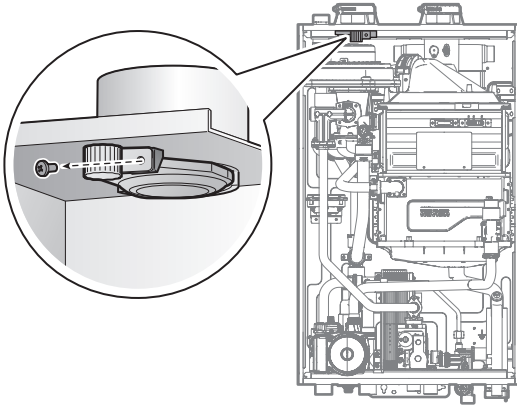

5. Pull the filter out of the boiler.

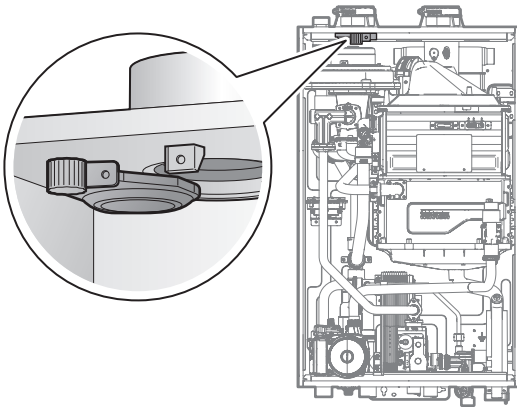

6. Remove the filter from the plastic assembly and clean it with a toothbrush and clean running water.



7. Allow the filter to dry completely.
8. Reinsert the filter into the plastic assembly.
9. Place the filter assembly back into the boiler and secure it with the screw.
10. Replace the front cover.
11. Reconnect the power supply to the boiler.
12. Press the Power button on the front panel to turn on the boiler.

4.6 Protecting the Boiler from Freezing

⚠ CAUTION

Damage due to freezing is not covered by the Navien limited warranty.

- Freezing damage is most likely to occur due to back drafting caused by negative pressure in the building. This is not a manufacturing defect, and therefore, Navien will not warrant any damages due to freezing. The installer is responsible for ensuring that there is sufficient make-up air to avoid such a situation and the owner is responsible for ensuring that protection against freezing is maintained.
- To avoid freezing issues, we strongly recommend the use of a direct vent exhaust and intake system. Your installer should ensure that the exhaust vent pipe and the air intake pipe are both connected directly from the collars on the top of the boiler to the outdoors. This type of vent system minimizes air movement within the boiler.
- This boiler has an optional recirculation mode that is used for freeze protection. This mode should prevent the boiler from freezing, even if the intake air duct is not vented directly.
- The boiler is designed for indoor installation only.

To ensure that the boiler does not freeze, follow these guidelines:

- **Do not unplug the power supply cord**, except for routine maintenance. The boiler has a freeze protection function that requires electricity. The freeze protection function will operate regardless of whether or not the power is turned on or off, as long as the electric supply is still connected.
- **Do not close the gas valve**, except for routine maintenance, as this will limit additional freeze protection.
- **If the boiler will not be used for an extended period, drain the boiler.**

If the power or gas supplies must be disconnected for an extended period, drain the boiler. Freezing damage may occur if there is water remained in the boiler in cold weather.

If hot water will not flow and you suspect that the boiler is frozen, follow these steps:

1. Press the Power button on the front panel to turn off the boiler.
2. Close the gas valve.

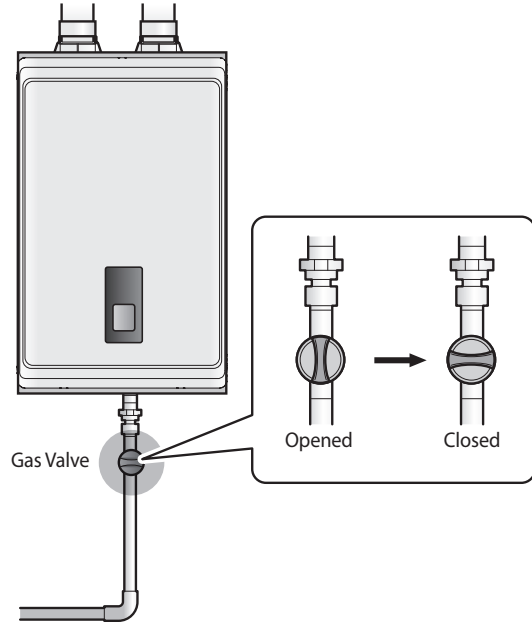

3. Open the hot water faucet that is closest to the boiler.
4. Use a hair dryer or a portable electric heater to heat up both the primary and secondary Heat Exchangers.
5. Check every few minutes to see if water is running at the open faucet.

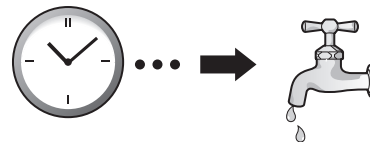

6. When the water starts flowing again, check the boiler and piping for leaks. If you detect any leaks or the boiler is not operating properly, contact an authorized technician or licensed professional.

Note

This boiler requires very little maintenance, however a qualified technician should inspect the boiler at the beginning of every heating season and/or when there is a problem.

4.7 Maintenance Schedules

Owner maintenance	
Daily	<ul style="list-style-type: none"> • Check boiler area • Check pressure / temperature gauge
Monthly	<ul style="list-style-type: none"> • Check vent piping • Check air piping (if installed) • Check air and vent termination screens • Check relief valve • Check condensate drain • Check air vents
Periodically	<ul style="list-style-type: none"> • Test low water cutoff (if used) • Reset button (low water cutoff)
Every 6 months	<ul style="list-style-type: none"> • Check boiler piping (gas and water) for leaks • Operate relief valve
End of season months	<ul style="list-style-type: none"> • Shut boiler down (unless boiler is used for domestic hot water)

Service technician (See the following instructions)	
Annual Start-up	<p>General:</p> <ul style="list-style-type: none"> • Address reported problems • Inspect interior; clean and vacuum if necessary • Clean condensate trap and fill with fresh water • Check for leaks (water, gas, flue, condensate) • Verify flue and air lines in good condition and sealed tight • Check system water pressure/system piping/expansion tank • Check control settings • Check ignition and flame rod (clean and reposition) • Check wiring and connections • Flame inspection (stable, uniform) • Flame signal <p>If combustion or performance indicate need:</p> <ul style="list-style-type: none"> • Flush heat exchanger • Remove and clean air intake filter. • Remove and clean space heating strainer. • Remove and clean inlet water filter.



WARNING

- Follow the service and maintenance procedures given throughout this manual and in component literature shipped with the boiler. Failure to perform the service and maintenance could result in damage to the boiler or system.
- Failure to follow the directions in this manual and component literature could result in severe personal injury, death, or substantial property damage.
- The boiler should be inspected annually only by a qualified service technician. In addition, the maintenance and care of the boiler must be performed to assure maximum boiler efficiency and reliability. Failure to service and maintain the boiler and system could result in equipment failure.
- Electrical shock hazard – Turn off power to the boiler before any service operation on the boiler except as noted otherwise in this instruction manual. Failure to turn off electrical power could result in electrical shock, causing severe personal injury or death.

Addressing the Reported Problems

- Inspect any problems reported by the owner and correct before proceeding.

Inspecting the Installation Area

1. Verify that boiler area is free of any combustible materials, gasoline and other flammable vapors and liquids.
2. Verify that air intake area is free of any of the contaminants listed in Installation & Operation Manual. If any of these are present in the boiler intake air vicinity, they must be removed. If they cannot be removed, reinstall the air and vent lines per the Installation and Operation Manual.

Inspecting the Boiler Interior

1. Remove the front cover and inspect the interior of the boiler.
2. Vacuum any sediment from inside the boiler and components. Remove any obstructions.

Cleaning the Condensate Trap

1. Inspect the condensate drain line, condensate fittings, and condensate trap.
2. Remove any sediment in the trap.
3. Fill with fresh water until the water begins to pour out of the drain.

Checking all Piping for Leaks

Eliminate all system or boiler leaks. Continual fresh makeup water will reduce boiler life. Minerals can build up in sections, reducing heat transfer, overheating heat exchanger, and causing heat exchanger failure. Leaking water may also cause severe property damage.

1. Inspect all water and gas piping and verify to be leak free.
2. Look for signs of leaking lines and correct any problems found.

Checking the Flue Vent System and Air Piping

1. Visually inspect the entire flue gas venting system and air piping for blockage, deterioration or leakage. Repair any joints that show signs of leakage. Verify that air inlet pipe is connected and properly sealed (if installed).
2. Verify that boiler vent discharge and air intake are clean and free of obstructions.



WARNING

Failure to inspect for the above conditions and have them repaired can result in severe personal injury or death.

Checking the Water System

1. Verify all system components are correctly installed and operational.
2. Check the cold fill pressure for the system. Verify it is correct (must be a minimum of 12 psi).
3. Watch the system pressure as the boiler heats up (during testing) to ensure pressure does not rise too high.

Note

- If the system contains glycol, test for proper concentration as recommended by manufacturer.
- Excessive pressure rise indicates expansion tank sizing or performance problem.

4. Inspect automatic air vents and air separators. Remove air vent caps and briefly press push valve to flush vent.
5. Replace caps. Make sure vents do not leak. Replace any leaking vents.

Checking Expansion Tank

- Expansion tanks provide space for water to move in and out as the heating system water expands due to temperature increase or contracts as the water cools.
- Perform annual checks as recommended by manufacturer to ensure proper operation.

Checking the Pressure Relief Valves

1. Inspect the relief valve and lift the lever to verify flow. Before operating any relief valve, ensure that it is piped with its discharge in a safe area to avoid severe scald potential.

Note

Safety relief valves should be re-inspected **at least once every three years**, by a licensed plumbing contractor or authorized inspection agency, to ensure that the product has not been affected by corrosive water conditions and to ensure that the valve and discharge line have not been altered or tampered with illegally.



WARNING

Certain naturally occurring conditions may corrode the valve or its components over time, rendering the valve inoperative. Such conditions are not detectable unless the valve and its components are physically removed and inspected. This inspection must only be conducted by a plumbing contractor or authorized inspection agency – not by the owner. Failure to re-inspect the boiler relief valve as directed could result in unsafe pressure buildup, which can result in severe personal injury, death, or substantial property damage.



WARNING

Following installation, the valve lever must be operated **at least once a year** to ensure that waterways are clear. Certain naturally occurring mineral deposits may adhere to the valve, rendering it inoperative. When manually operating the lever, water will discharge and precautions must be taken to avoid contact with hot water and to avoid water damage.

Before operating lever, check to see that a discharge line is connected to this valve directing the flow of hot water from the valve to a proper place of disposal. Otherwise severe personal injury may result. If no water flows, valve is inoperative. Shut down the boiler until a new relief valve has been installed.

2. After following the above warning directions, if the relief valve weeps or will not seat properly, replace the relief valve. Ensure that the reason for relief valve weeping is the valve and not over-pressurization of the system due to expansion tank waterlogging or undersizing.

Inspecting the Ignition and Flame Detector Electrodes

1. Remove the ignition and flame detector electrodes from the boiler heat exchanger.
2. Remove any deposits accumulated on the ignition/flame detector electrode. If the electrodes cannot be cleaned satisfactorily, replace with new ones.
3. Replace ignition/flame detector electrode, making sure gasket is in good condition and correctly positioned.

Checking the Ignition Ground Wiring

1. Check that the ground wire is in good condition and securely attached to the boiler casing.
2. Check ground continuity of wiring using continuity meter.
3. Replace ground wires if ground continuity is not satisfactory.

Checking all Boiler Wiring

- Inspect all boiler wiring, making sure wires are in good condition and securely attached.

Checking the Control Settings

1. From the front panel, enter the Diagnostics Mode and check all settings. Adjust settings if necessary.
2. Check settings of external limit controls (if any) and adjust if necessary.

Performing Start-up and Checks

1. Start boiler and make sure that the boiler is operating properly.
2. Verify cold fill pressure is correct and that operating pressure does not go too high.

Check the Burner Flame

1. Inspect flame through observation window.
2. If the flame is unsatisfactory at either high fire or low fire, check for obstructions in the venting and ensure that the air intake filter is clean.

Review with the Owner

1. Review the User's Information Manual with the owner.
2. Emphasize the need to perform the maintenance schedule.
3. Remind the owner of the need to call a licensed contractor should the boiler or system exhibit any unusual behavior.
4. Remind the owner to follow the proper shutdown procedure and to schedule an annual start-up at the beginning of the next heating season.

Flushing the Heat Exchanger

CAUTION

Flushing the heat exchanger is a somewhat complicated procedure. Read the following instructions carefully before attempting this procedure. If you are uncertain about any of the steps in the procedure, contact an authorized technician or licensed professional. Keep in mind that improper maintenance can void your warranty.

Refer to the “2.2 Parts of the Boiler” on page 6 for details about part locations.

Before flushing the Heat Exchanger, gather the following items:

- A bucket that is 5 gallons or larger
- Cleaning solution diluted with water
- 3 hoses
- A water circulation pump

To flush the Heat Exchanger:

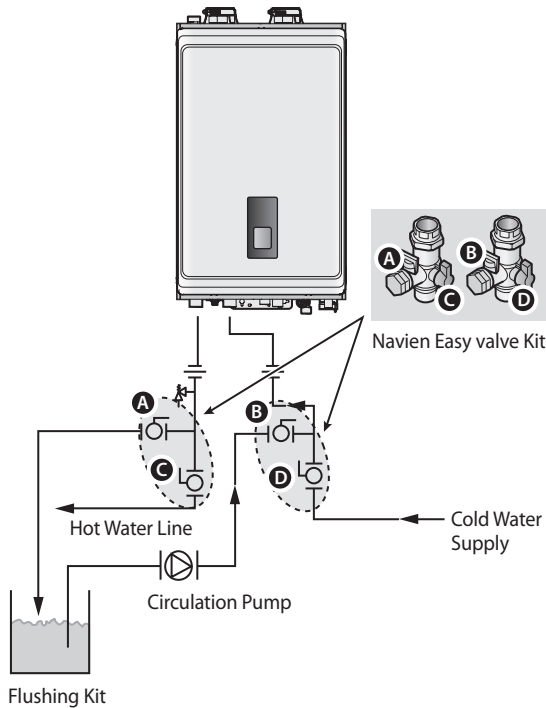

1. Press the Power button on the front panel to turn off the boiler.
2. Disconnect the power supply to the boiler.
3. Close the “C” and “D” valves on the supply and return water lines.
4. Connect one tube to the “A” valve and place the free end in the bucket.
5. Connect one of the tubes to the circulation pump outlet and the return water line at the “B” valve.
6. Connect one tube to the circulation pump inlet and place the free end in the bucket.
7. Pour the cleaning solution into the bucket.
8. Open both “A” and “B” valves.
9. Turn on the circulation pump and allow the solution to circulate through the boiler for at least 45 minutes.
10. Rinse the cleaning solution from the boiler:
 - a. Remove the free end of the drain tube from the bucket and place it in the condensate drain or laundry tub (wherever the boiler drains).
 - b. Close the “B” valve and open the “D” valve. Do not open the “C” valve yet.
 - c. Allow water to flow through the boiler for 5 minutes.
 - d. Close the “A” valve and open the “C” valve.
11. Disconnect all tubes.
12. Remove the strainer from the boiler and clean out any residue.
13. Reinsert the filter and ensure the filter cap is securely tightened.
14. Reconnect the power supply to the boiler.
15. Press the Power button on the front panel to turn on the boiler.

5. Troubleshooting

5.1 Solving Basic Problems

If you experience a problem with the boiler, refer to the following chart for possible remedies. Error codes that appear on the front panel display are explained in the following section.

For minor problems, resetting the boiler may resolve the issue. To reset the boiler, press the Reset button on the front panel.

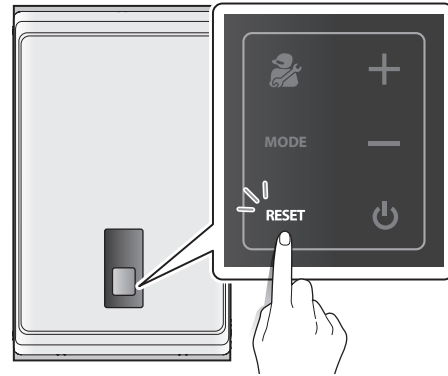

If resetting the boiler and attempting the remedies suggested below do not resolve the problem, contact an authorized technician, a licensed professional, or Technical Support at 1-800-519-8794 for service instructions.

Problem	Possible Cause(s)	What to do
No water comes out when the hot water tap is opened.	<ul style="list-style-type: none"> Is the cold water inlet filter clean? Is an error code displayed on the front panel? Is the boiler frozen? 	<ul style="list-style-type: none"> Ensure that the shut-off valves on the hot and cold pipes are open. If an error code is displayed, refer to "5.2 Understanding Error Codes" on page 22.
The water from the hot water faucet is cold or turns cold and stays cold.	<ul style="list-style-type: none"> Is the hot water faucet open wide enough draw at least 0.5 gallons of water per minute (GPM) through the boiler? Is an error code displayed on the front panel? 	If an error code is displayed, refer to "5.2 Understanding Error Codes" on page 22.
The water from the hot water faucet is not hot enough.	Is the set temperature too low?	<ul style="list-style-type: none"> Check the boiler's temperature setting. Refer to "3.2 Adjusting the Temperature" on page 9. Check for cross plumbing between the cold and hot water lines.
The water from the hot water faucet is too hot.	Is the set temperature set too high?	Check the boiler's temperature setting. See "3.2 Adjusting the Temperature" on page 9.
Space heating side malfunction	Is the setting temperature too low?	Check the boiler's temperature setting. See "3.2 Adjusting the Temperature" on page 9.
	Is there power to the system, or is the system in stand by?	Make sure the power is on, and plugged into the outlet with the correct voltage. Press the Power button and raise the setting temperature. Make sure the boiler is turned on.
	Is the system running for domestic hot water (DHW)?	When the unit is heating for DHW, the heating side does not work.
	Is the filter on the heating side restricted?	Clean out filters that belong to the heating side.

5.2 Understanding Error Codes

When an error code appears on the front panel, refer to the following chart for a definition and possible remedy for the situation.

Error Code	Reason	Self-diagnostic / Action
E003	Ignition failure	Ensure that the main gas supply valve is open.
E004	False flame detection	Ensure that the electrical cord is properly grounded.
E012	Flame loss	<ul style="list-style-type: none"> • Clean the intake air filter. • Ensure that the electrical cord is properly grounded.
E016	Overheating of heat exchanger	<ul style="list-style-type: none"> • Turn off the system for at least 30 minutes, and then restart it. • Clean the Heating Return filter. • Flush the heat exchanger.
E030	Abnormal exhaust temperature	Contact Technical Support at 1-800-519-8794.
E046	Abnormal operation: limit control	Contact Technical Support at 1-800-519-8794.
E047	Abnormal operation: exhaust thermostat	Contact Technical Support at 1-800-519-8794.
E060	Abnormal operation: dual venturi	Contact Technical Support at 1-800-519-8794.
E109	Abnormal operation: fan motor	Clean the intake air filter.
E110	Abnormal air pressure	<ul style="list-style-type: none"> • Ensure that the exhaust pipe is free of obstructions. • Clean the intake air filter.
E205	Heating supply thermistor open or short circuit	Contact Technical Support at 1-800-519-8794.
E218	Heating return thermistor open or short circuit	Contact Technical Support at 1-800-519-8794.
E351	Abnormal Auto feeder valve (make-up water)	Contact Technical Support at 1-800-519-8794.
E352	High water pressure	Contact Technical Support at 1-800-519-8794.
E353	Abnormal operation: water pressure sensor	Contact Technical Support at 1-800-519-8794.
E407	Hot water outlet thermistor open or short circuit	Contact Technical Support at 1-800-519-8794.
E421	Cold water inlet thermistor open or short circuit	Contact Technical Support at 1-800-519-8794.
E439	Abnormal operation: flow sensor	Reset the boiler from the front panel.
E515	Abnormal operation: PCB	<ul style="list-style-type: none"> • Ensure that the electrical cord is properly grounded. • Reset the boiler from the front panel.
E517	Abnormal operation: DIP switch setting	Contact Technical Support at 1-800-519-8794.
E594	Abnormal operation: EEPROM	Contact Technical Support at 1-800-519-8794.
E615	Abnormal operation: input and memory	Contact Technical Support at 1-800-519-8794.
E736	Abnormal operation: cascade communication	Contact Technical Support at 1-800-519-8794.
E740	Abnormal operation: outdoor temperature sensor (appears only when the outdoor reset curve is enabled).	<ul style="list-style-type: none"> • Ensure that the outdoor reset curve is configured properly. • Check the outdoor temperature sensor wiring connection.
E777	Abnormal operation: LWCO	<ul style="list-style-type: none"> • Check the LWCO wiring connection • Ensure that the system water level is appropriate. • Add make-up water to the system if necessary.
E782	Abnormal operation: main panel communication	Contact Technical Support at 1-800-519-8794.

If any of these remedies do not resolve the problem, contact Technical Support at 1-800-519-8794.

LIMITED WARRANTY NAVIEN, INC.

Warranty Period

Navien products come with a limited warranty covering labor, parts and the heat exchanger. The following warranty periods begin to run from the date of original installation. The date of original installation must be provided to Navien, and upon request, proof of the original installation date must also be provided to Navien. When the product is installed in a new construction, the commencement date shall be dated upon which the end-user takes title to the property.

APPLICABLE WARRANTY PERIOD

Period of Coverage*		
Heat Exchanger	All other parts and components	Labor
10 years	5 years	1 year

* The warranty periods apply only to single family, residential installations.

Warranty Claim Procedures

To obtain warranty repair service, the end user or homeowner must contact the original installer of your Navien product. If the original installer cannot be identified, the end user or homeowner may contact Navien's Technical Administration Department at **1-800-519-8794**. Proof of purchase is required to obtain warranty service.

Warranty Service

At its option, Navien will replace the defective component (part(s) or heat exchanger), in accordance with the terms of this Limited Warranty, if it fails in normal use and service during the applicable warranty period identified above. The replacement component must be Navien original factory component. Navien, at its sole discretion, may replace the product with a new or refurbished product of comparable quality and design. The replacement component or product will be warranted only for the unexpired portion of the original component's applicable warranty period. Payment for labor in completing the warranty service is subject to Navien's prior written approval and shall be subject to Navien's schedule of approved labor allowances.

Warranty Exclusions

Navien's Limited Warranty shall be void in the event of an occurrence of any of the following:

- Improper installation, failure to install in strict compliance with the Installation & Operation Manual procedures, installed by a non-licensed installer, and installation in violation of applicable rules, laws or building codes.
- Product purchased through the internet, other e-commerce channels, or any installer that obtained the product from a supplier or distributor not authorized by Navien.
- Failure to perform regular maintenance, misuse, operation at settings other than those recommended or specified, non-compliance with instructions or guidelines set forth in the User's Information Manual.
- Modification or alteration of the product in any manner, including but not limited to, removal of any component or part, addition of any non-approved components, relocating or moving the product from its original installation site, or any accidental or intentional damage to the Product.
- Installation in commercial or multi-dwelling applications or for non-recommended uses.
- Any damage caused by local adverse conditions including but not limited to hard water deposits, lime or mineral build-up, operating in corrosive atmospheric elements.
- Damage or problems caused by gas flow issues, electrical surges, flooding, fire, abnormal external temperature, and any other cause of damage not directly caused by a manufacturing defect.
- Installer's failure to fully comply with the warranty service and return policy procedures previously provided to installer and as is available on Navien's website. Such policies include but are not limited to the installer's failure to first contact Navien Technical Support while in front of the product for purposes of trouble shooting the identified problem or issue.

- Performance problems caused by improper sizing of the boiler, the gas supply line, the venting connection, combustion air openings, electric service voltage, wiring, fusing or any other components, parts or specifications.
- Improper conversion from natural gas to LP gas or LP gas to natural gas or attempt to operate with a type of gas not specified for the boiler.
- Any damage, malfunction or failure caused by abuse, negligence, alteration, accident, fire, flood, freezing, wind, lightning and other acts of God.
- Operating, using or storing the boiler in a corrosive or contaminated atmosphere or environment.
- Operating the boiler at water temperatures outside the factory calibrated temperature limits and/or exceeding the maximum setting of the high limit control.
- Operating the boiler when it is not supplied with potable water at all times.
- Subjecting the heat exchanger to pressures or firing rates greater or lesser than those shown on the rating plate.
- Installation at any location outside the United States and Canada.
- Removal or alteration of the rating plate.

Other Terms: This Limited Warranty is subject further to the terms and conditions set forth herein and as may be further specified in the terms and conditions page located on Navien's website at www.navien.com. WITH THE EXCEPTION OF THIS LIMITED WARRANTY, NAVIEN DISCLAIMS ANY OBLIGATION OR LIABILITY WITH RESPECT TO THE PRODUCTS OR THEIR SALE AND USE, AND NAVIEN NEITHER ASSUMES NOR AUTHORIZES THE ASSUMPTION OF, ANY OBLIGATION OR LIABILITY IN CONNECTION WITH THE PRODUCTS. THIS DISCLAIMER INCLUDES ANY OTHER WARRANTIES, EXPRESS, IMPLIED OR STATUTORY RESPECTING THE PRODUCTS OR ANY PARTS OR COMPONENTS THEREOF, INCLUDING, BUT NOT LIMITED TO, ANY IMPLIED WARRANTY OF MERCHANTABILITY OR FITNESS FOR A PARTICULAR PURPOSE. Navien's total liability for any claim arising hereunder shall not exceed the purchase price which you paid for the product. NAVIEN SHALL NOT IN ANY EVENT BE LIABLE FOR INDIRECT, SPECIAL, CONSEQUENTIAL OR LIQUIDATED DAMAGES OR PENALTIES, INCLUDING CLAIMS FOR LOST REVENUE, PROFITS OR BUSINESS OPPORTUNITIES, EVEN IF NAVIEN HAD OR SHOULD HAVE HAD ANY KNOWLEDGE, ACTUAL OR CONSTRUCTIVE, OF THE POSSIBILITY OF SUCH DAMAGES.

Memo
