

SPECIFICATIONS

30" SEDONA VANITY TOP

VNT302- Antique

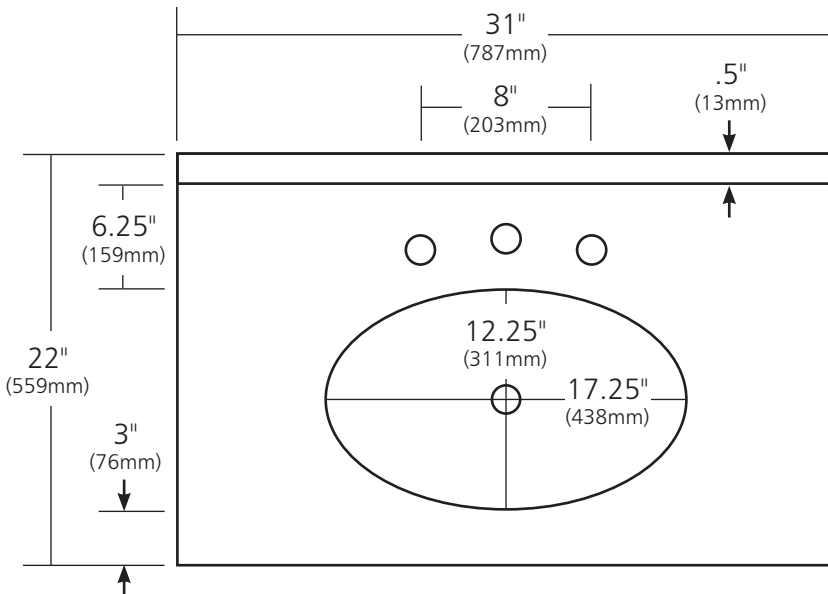

PRODUCT DETAILS

- 31" x 22" OD (785mm x 559mm)
- Basin: 17.25" x 12.25" x 5.25" (438mm x 311mm x 133mm)
- Hand hammered, 16 gauge recycled copper
- 3.5" (89mm) backsplash
- Pre-drilled for 8" (13mm) faucet spread
- 1.5" (38mm) drain opening

COORDINATING PRODUCTS

- Drains: DR120, DR150 or DR160
- Sedona Mirrors

IMPORTANT

Due to the handcrafted nature of this product, it will vary in finish, texture, hammering, and other details. Dimensions may vary up to 1/2" (13mm).

