

# GALAXY™ 48 OUTDOOR GAS FIREPLACE



## Specifications

Model (without trim)	Width		Height		Depth		Viewing Area
	Actual	Framing	Actual	Framing	Actual	Framing	
GSS48E	50 1/2	50 3/4	24 1/2	24 3/4	19 9/32	18 7/16	16.5 x 47.5
GSS48STE					24		

## Dimensions

Model	BTU
GSS48NE	55,000
GSS48PE	53,500

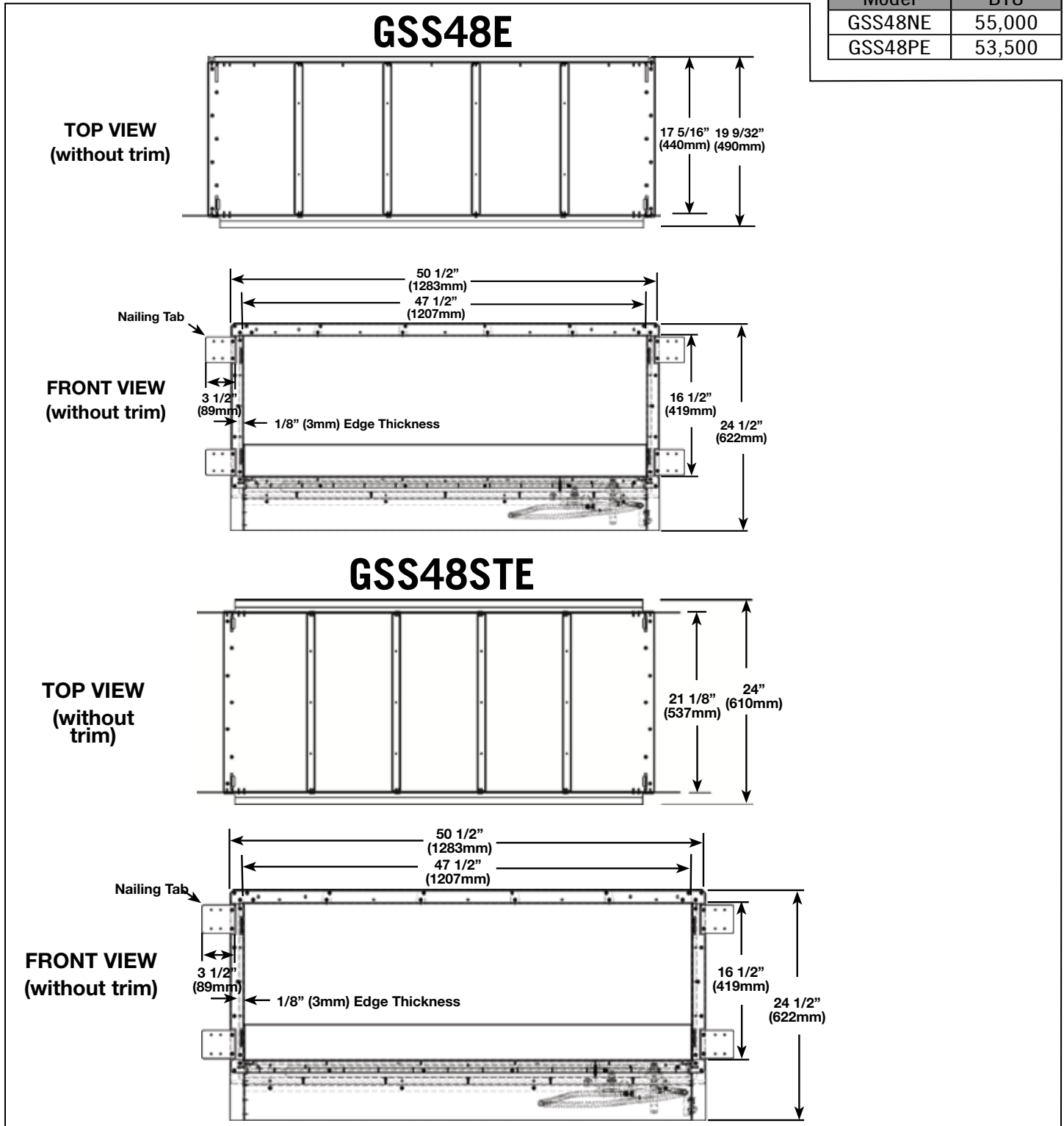

# GALAXY™ 48 OUTDOOR GAS FIREPLACE



Product information provided is not complete and is subject to change without notice. Please consult the installation manual for the most up to date installation information.

## Framing

### Minimum Framing Dimensions - Front View

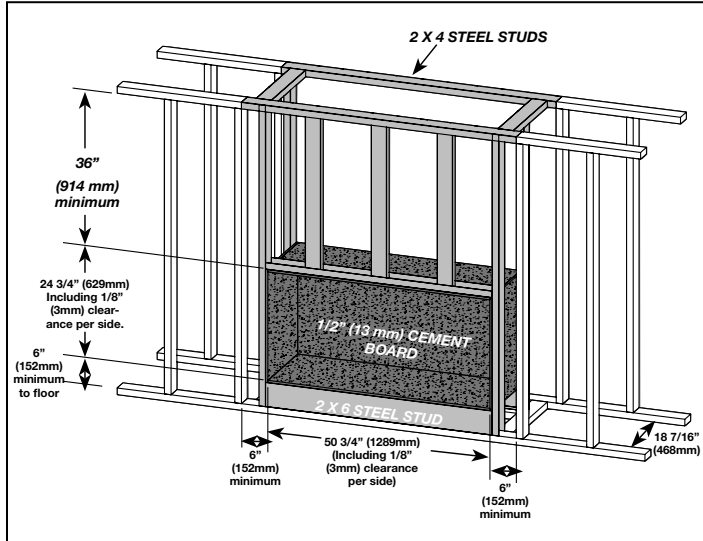

### Minimum Framing Dimensions - Rear View

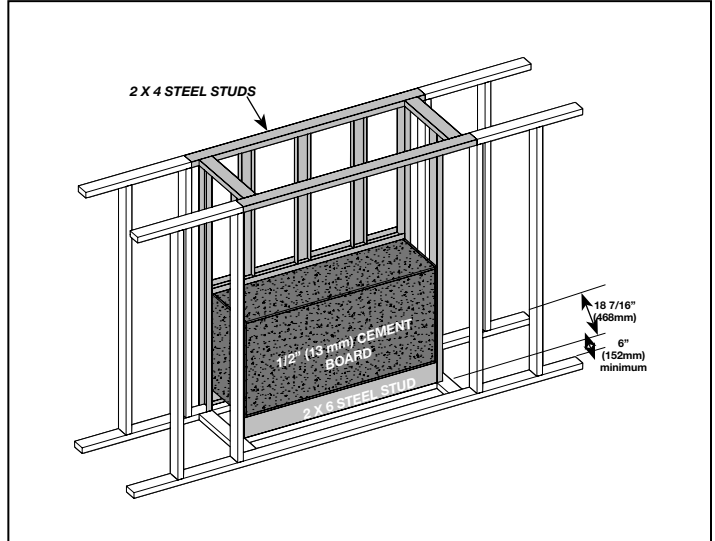

## Nailing Tabs

To install the appliance face flush with the finished surface, position the framework to accommodate the thickness of the finished surface. Screw the nailing tab to either side of the appliance and secure to the 2 x 4 steel framing. The tabs will facilitate the installation of either a 1/2" (13mm) or 3/4" (19mm) finished surface thickness.

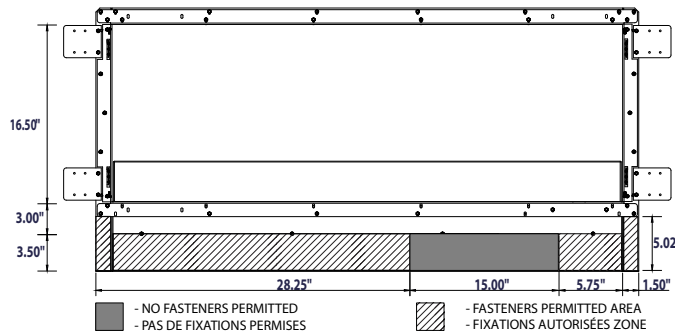

## Clearance to Combustibles

### ! WARNING

- Minimum clearance to combustibles must be maintained or a serious fire hazard could result.

Minimum Clearance To Combustibles		
	Clearance	Dimension
A	From Ground or other surface	6" (152 mm)
B	From Sides	6" (152 mm)
C	From Ceiling	36" (915 mm)
D	Alcove Width	60" (1524 mm) Minimum
E	Alcove Depth	24" (610 mm) Maximum

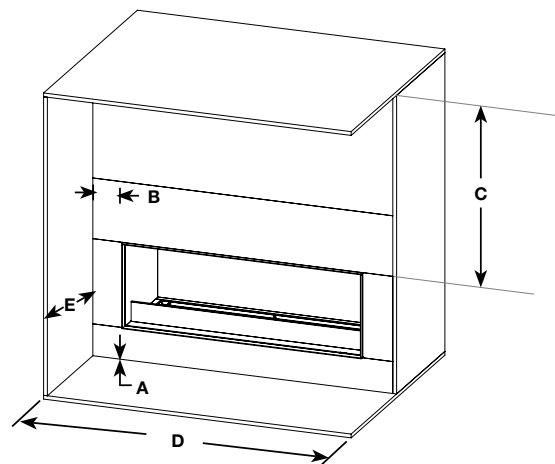

## Spécifications

Modèle (sans garniture)	Largeur		Hauteur		Profondeur		Dimensions de Vision
	Réel	Ossature	Réel	Ossature	Réel	Ossature	
GSS48E	50 1/2	50 3/4	24 1/2	24 3/4	19 9/32	18 7/16	16.5 x 47.5
GSS48STE					24		

## Dimensions

Modèle	BTU
GSS48NE	55 000
GSS48PE	53 500

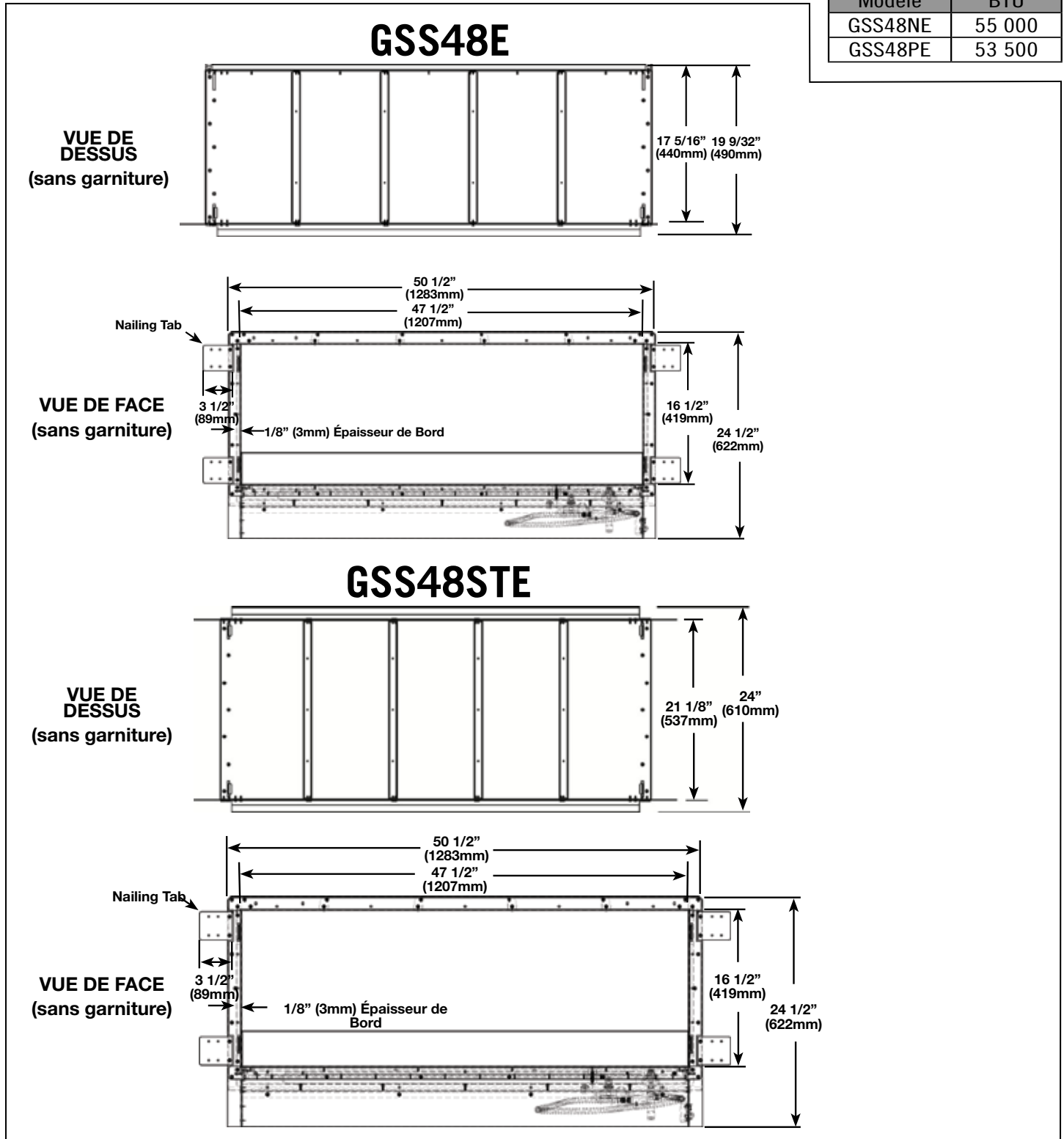

L'information du produit fourni n'est pas complet et est sujet de changer sans préavis. Consultez le manuel d'installation pour information d'installation actuel.

## Ossature

### Dimensions d'Ossature Minimum - Vue de Face

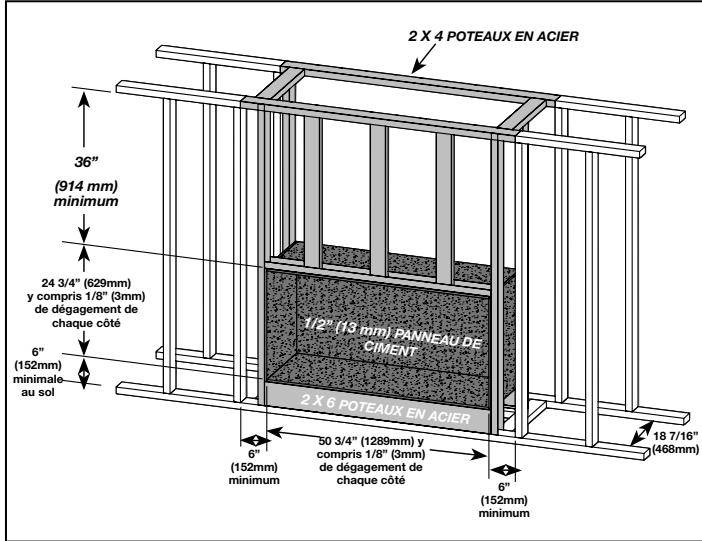

### Dimensions d'Ossature Minimum - Vue d'Arrière

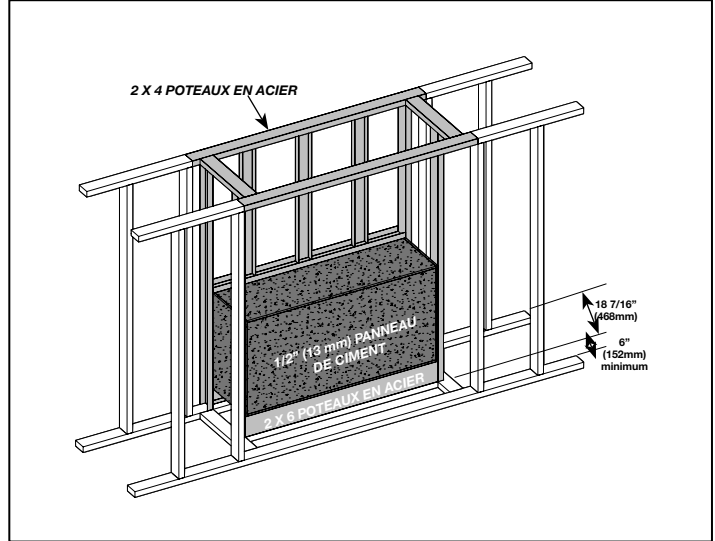

## Support de Fixation

Pour installer le devant de l'appareil à égalité avec la surface finie, positionnez la charpente de façon à prévoir l'épaisseur de la surface finie. Vissez les supports de fixation de chaque côté de l'appareil et fixez-les à la charpente d'acier de 2 x 4. Les supports faciliteront l'installation d'une surface finie d'une épaisseur de 1/2" (13mm) ou de 3/4" (19mm).

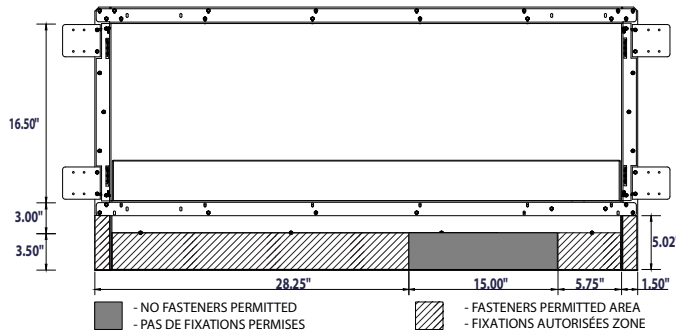

## Dégagements aux Matériaux Combustibles

### ⚠ AVERTISSEMENT

- Afin d'éviter un risque d'incendie, les dégagements minimaux aux matériaux combustibles doivent être maintenus.

Dégagements Minimale aux Matériaux Combustibles		
	Dégagement	Dimension
A	Du sol ou d'une autre surface	6" (152 mm)
B	Des côtés	6" (152 mm)
C	Du plafond	36" (915 mm)
D	Largeur de l'alcôve	60" (1524 mm) Minimum
E	Profondeur de l'alcôve	24" (610 mm) Maximum

