

Following these mounting instructions with the hardware included will be more than sufficient to support console installation.

Included Sink Installation Hardware

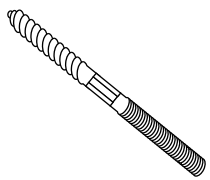

x2 hanger bolts (8mm)



x2 washer



x2 wall anchor



x2 insulation sleeve



x2 nuts

Console Installation Hardware



x1 allen wrench



x24 M5x10 Bolt

Tools You May Need

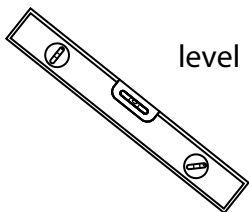

level

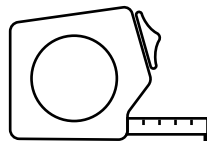

tape measure

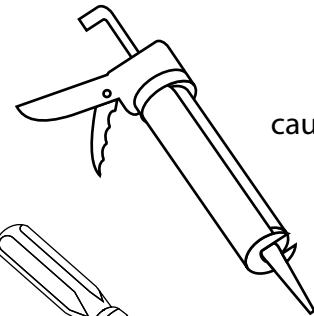

caulk

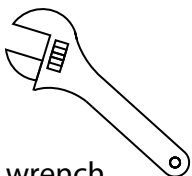

wrench



hammer

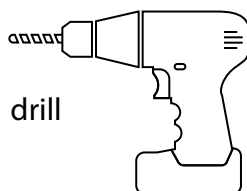

drill

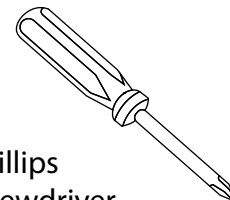

phillips screwdriver

1. Prepare Location

Locate studs in the wall. If the studs do not line up with the holes in the back of the sink, be sure to add sufficient wall supports behind the finished wall.

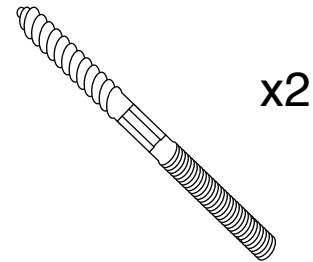
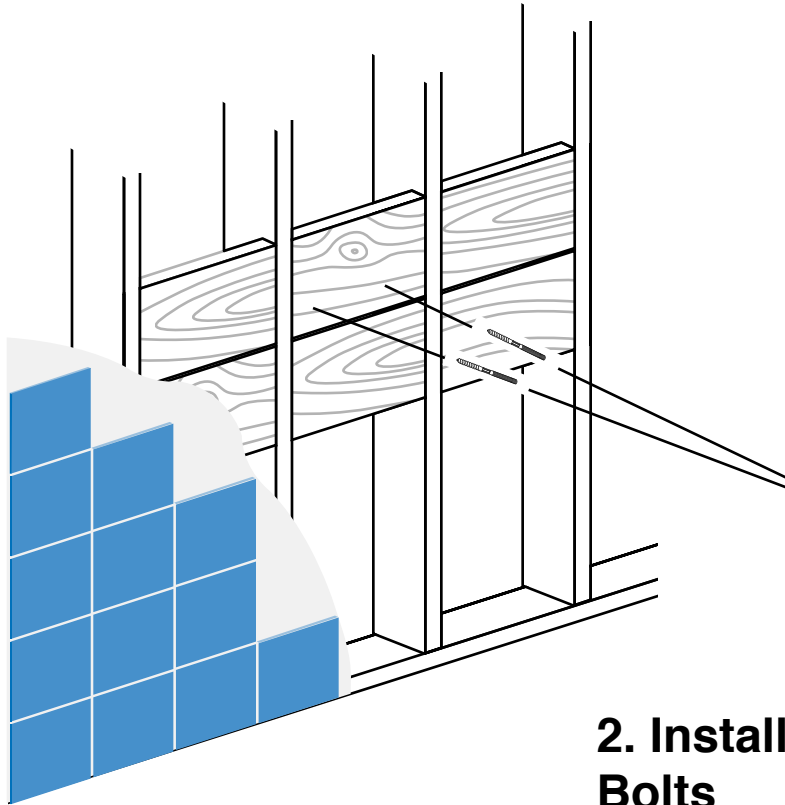

2. Install Hanger Bolts

Measure the distance between mounting holes in the back of the sink. Drill pilot holes in wood and screw in hanger bolts. Check position with a level.

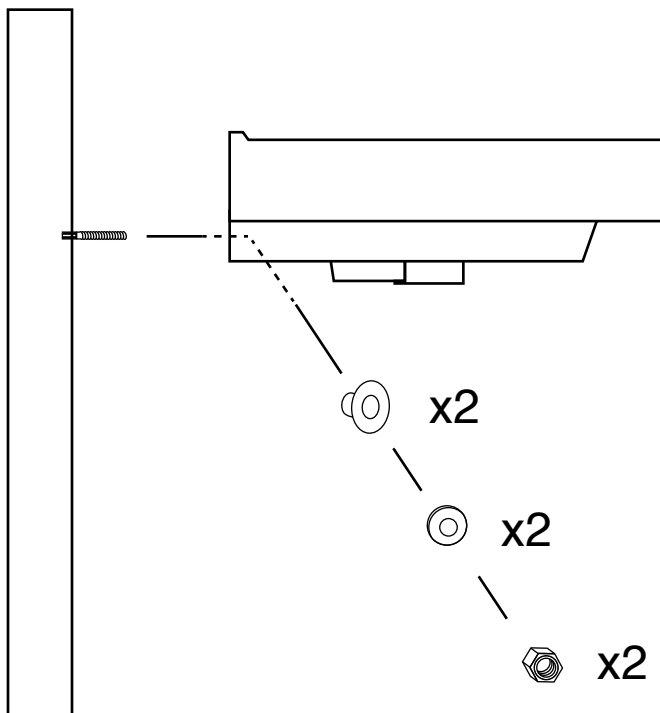

3. Secure Sink With Washers and Nuts

Thread the sink on to the two hanger bolts. Secure the sink with insulation sleeves, washers and nuts. Be careful not to over tighten the bolts. Over tightening can cause the sink to chip and crack.

4. Install Caulk

Finish the sink installation with a bead of caulk between the sink and wall.

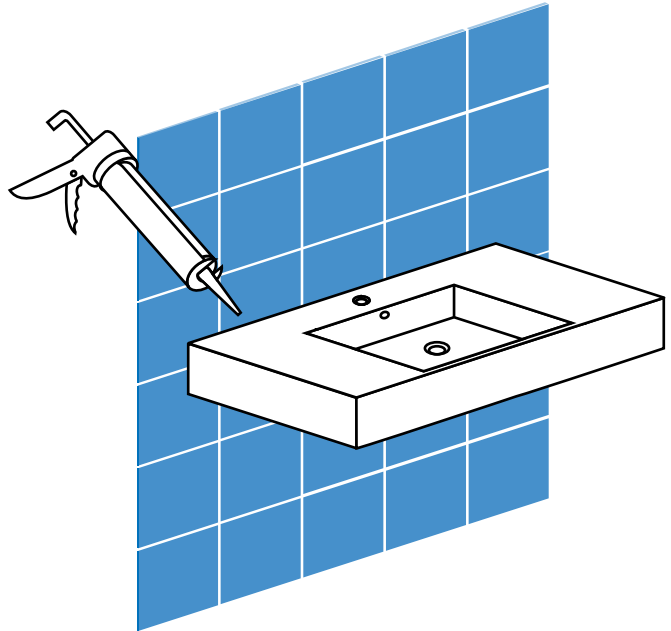

5. Assemble The Console

Assemble the console follow this sequence.

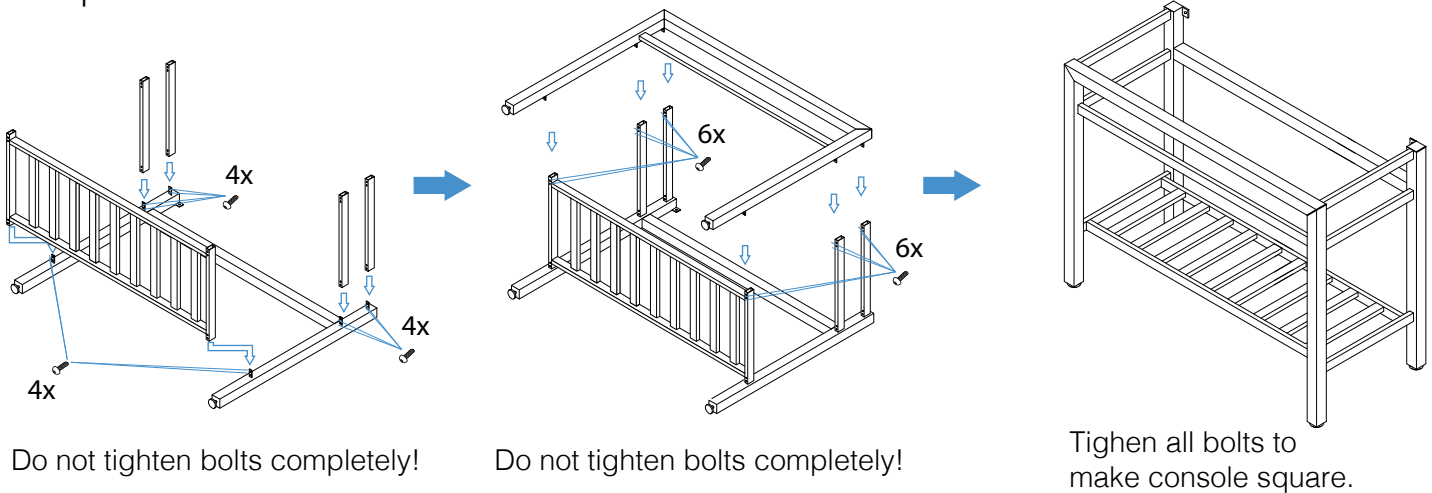

6. Mark Console Mounting Brackets

Place the console under the sink and mark the location of the brackets on the wall. Drill the holes for mounting.

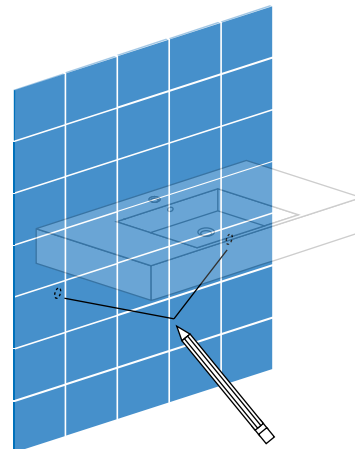

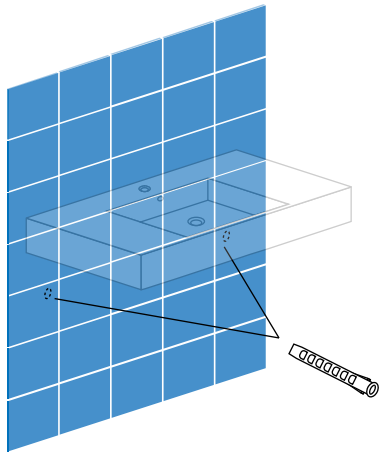

7. Install Wall Anchors

Install wall anchors for console base.

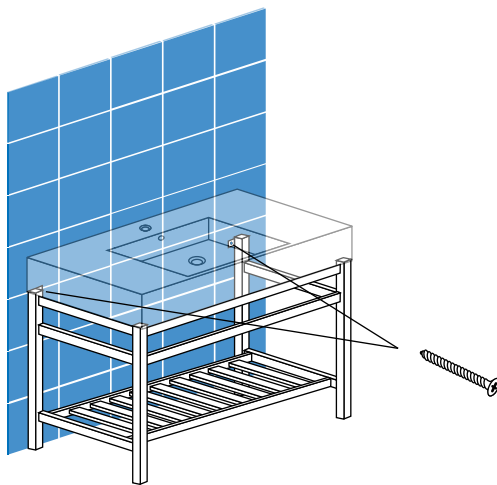

8. Mount Console Under Sink

Position the console under the sink. Mount the console to the wall with screws.

9. Sink Accessories

Complete your installation by adding the preferred plumbing accessories, such as the faucet, click clack drain, p-trap and angle valves to your sink.

