

Following these mounting instructions with the hardware included will be more than sufficient to support vanity installation.

### Included Sink Installation Hardware

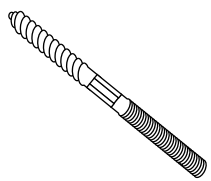

x4 Hanger Bolts (8mm)



x4 Washer



x2 Wall Anchor



x4 Insulation Sleeve



x2 Nuts

### Vanity Installation Hardware

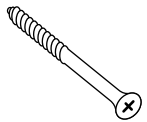

x9 Long Screw



x8 Short Screw



x3 Mounting Bracket



x7 Wall Anchor



x3 Nuts

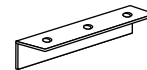

x1 Bottom Mounting Bracket

### Tools You May Need

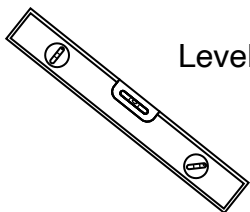

Level

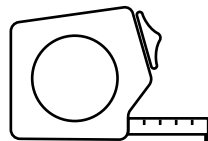

Tape Measure

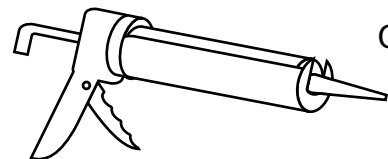

Caulk

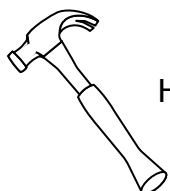

Hammer

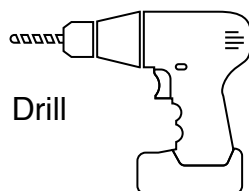

Drill

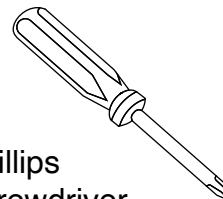

Phillips Screwdriver



Wrench

## 1. Prepare Location

---

Locate studs in the wall. If the studs do not line up with the holes in the back of the sink and vanity, be sure to add sufficient wall supports behind the finished wall.

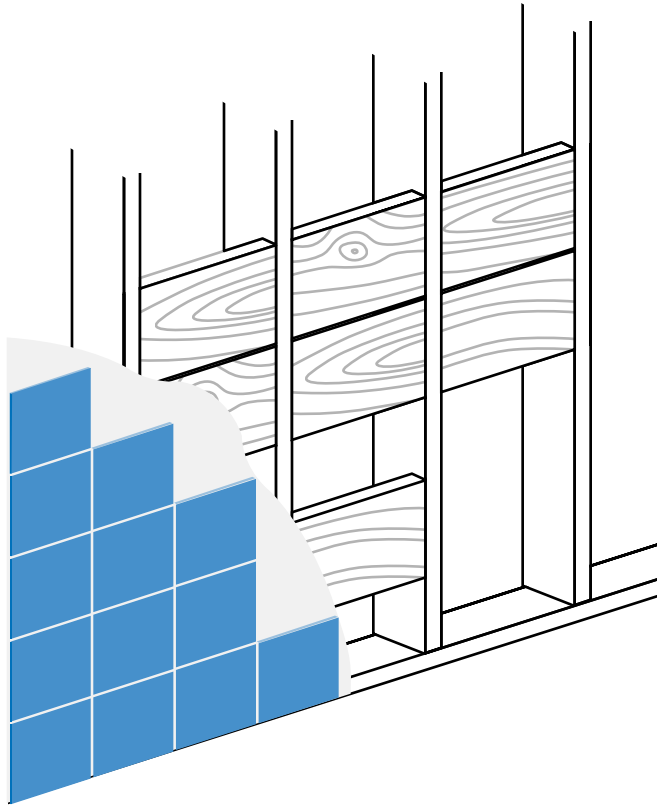

## 2. Install Legs

---

Lay vanity cabinet on it's back. screw on the feet with phillips screwdriver.

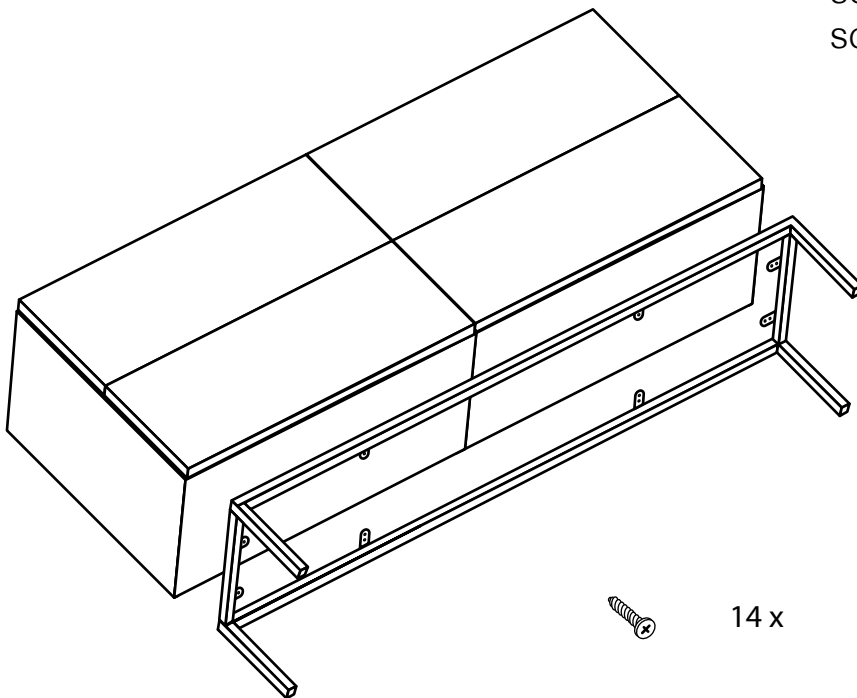

14 x

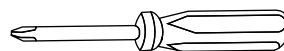

### 3. Mount Vanity Bracket

---

Mark the desired height of the vanity on the wall. Mark the location of the vanity. Drill pilot holes and install the mounting brackets. Check position with a level.

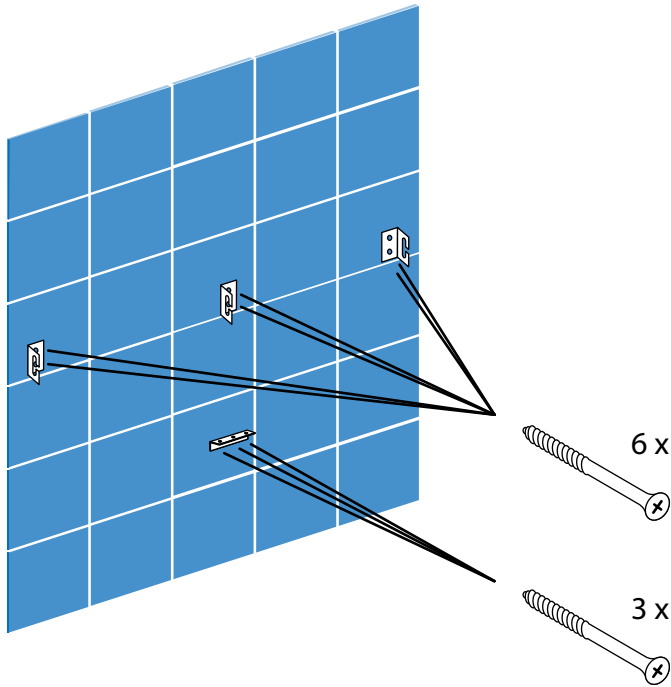

### 4. Install Vanity Base

---

Remove drawers. Slide vanity onto mounting brackets. Check for level. Secure with nuts.

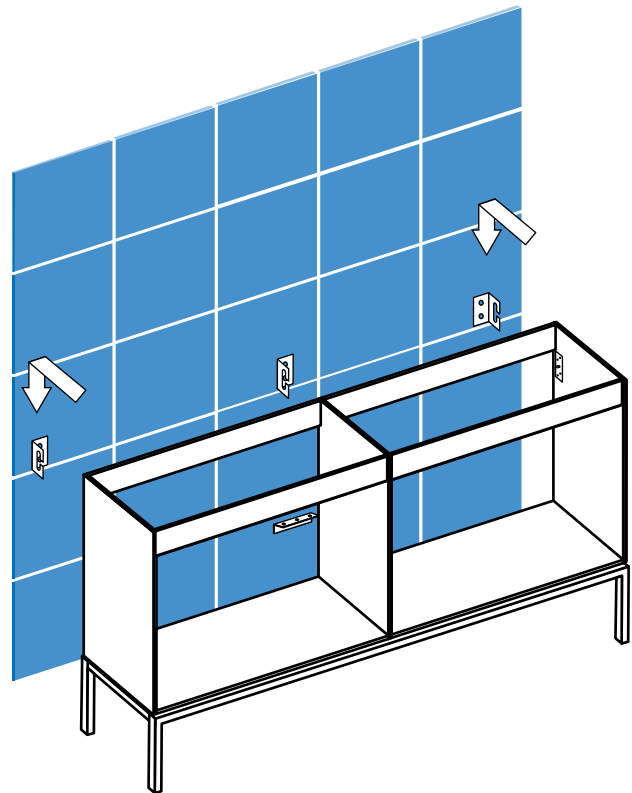
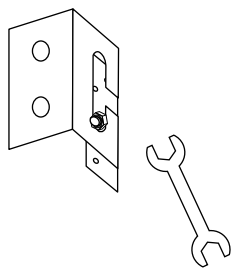

## 5. Install Hanger Bolts

---

Measure the distance between mounting holes in the back of the sink. Drill pilot holes and screw in hanger bolts. Check the position with a level.

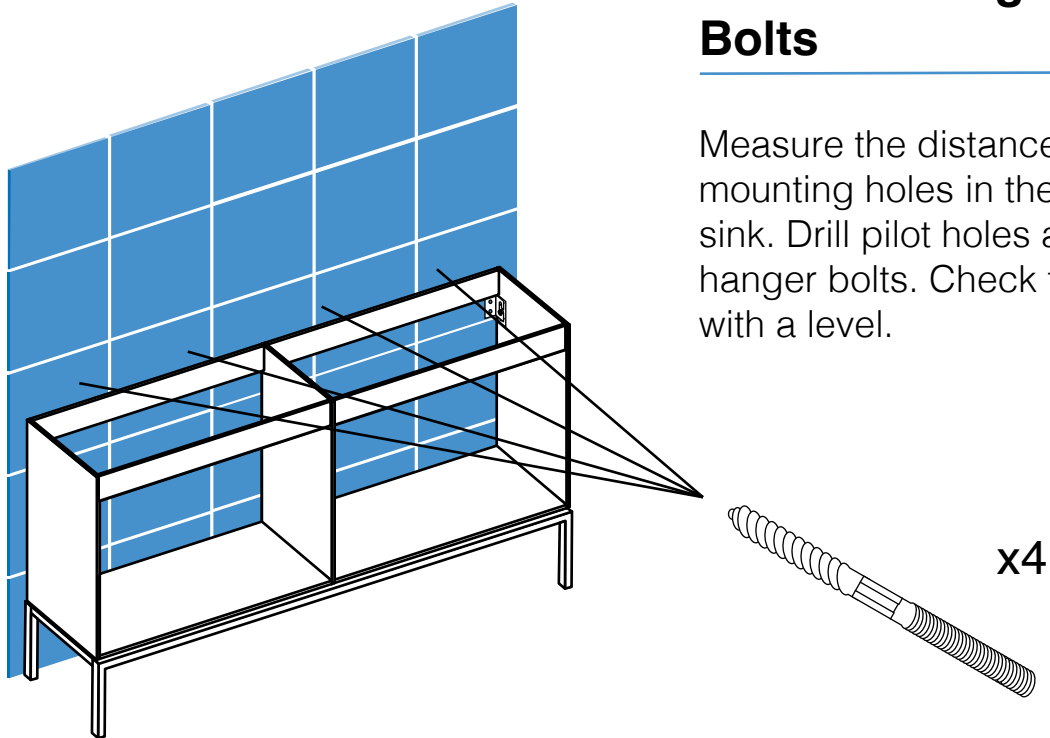

## 6. Mount Sink With Washers and Nuts

---

Thread the sink on to the two hanger bolts. Secure the sink with insulation sleeves, washers and nuts. Be careful not to over tighten the bolts. Over tightening can cause the sink to chip and crack.

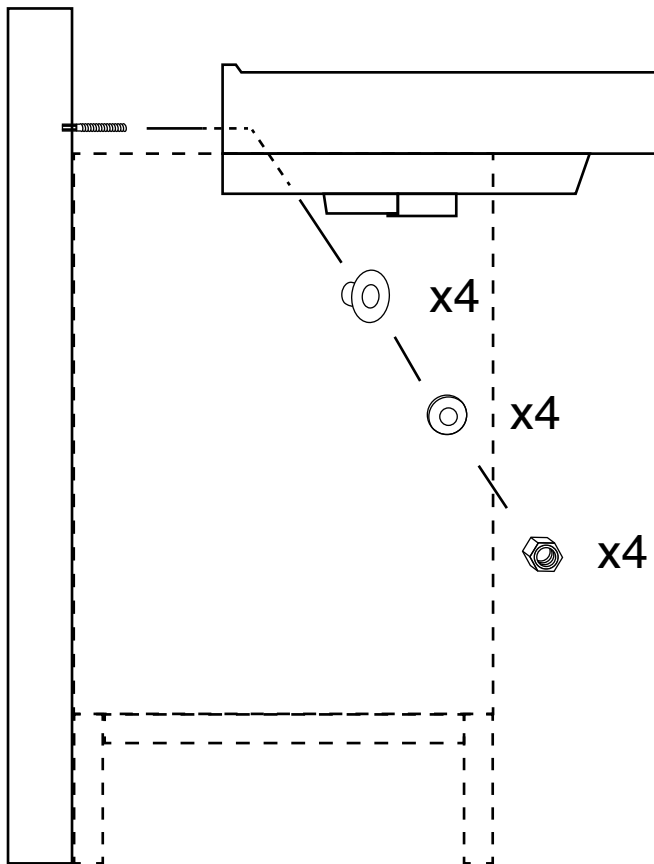

## 7. Install Caulk

---

Finish the sink installation with a bead of caulk between the sink and wall.

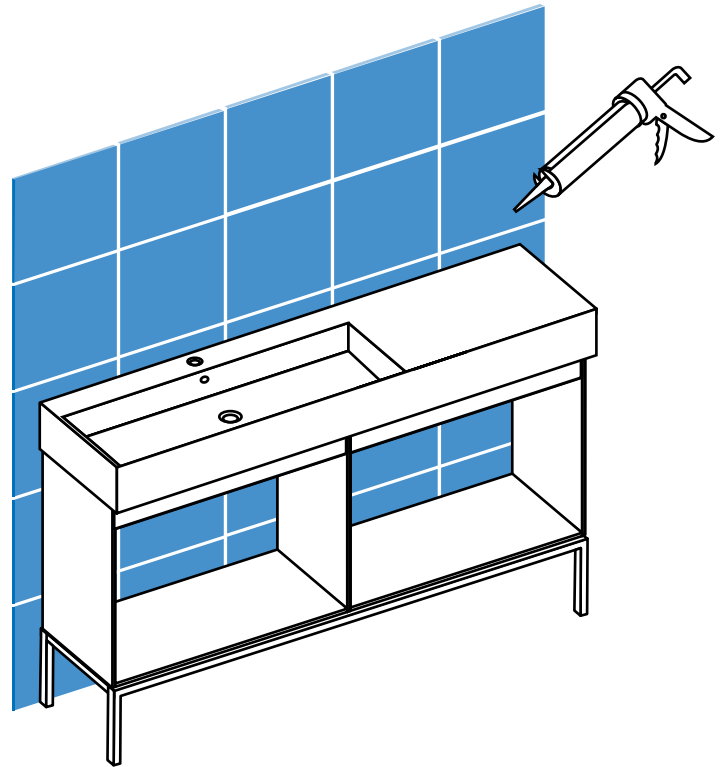

## 8. Install Handles

---

Screw on handles with phillips screwdriver. Replace drawers.

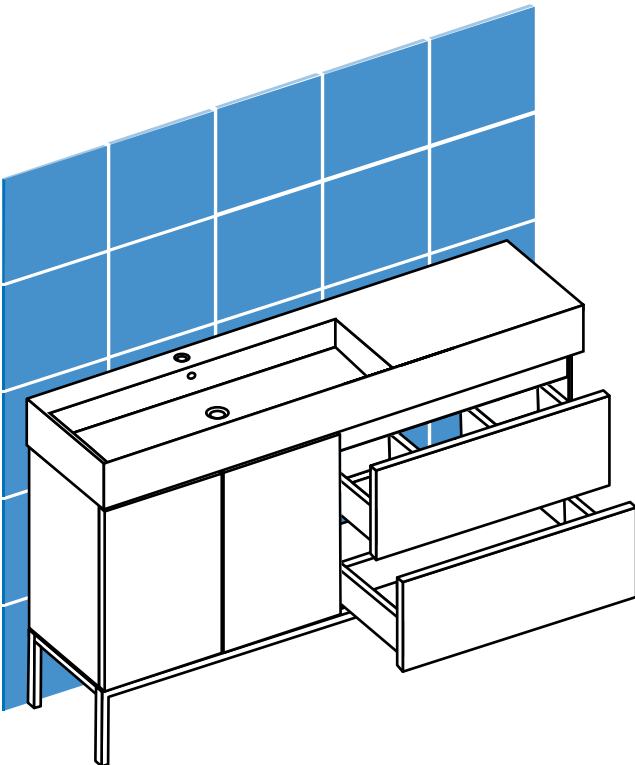

## 9. Vanity Accessories

Complete your installation by adding the preferred plumbing accessories, such as the faucet, click clack drain, p-trap and angle valves to your vanity.

