

Installation and Operational Manual

Effective March 1, 2019



Designer Collection

Mineral Composite Tubs

Installer: This booklet must be given to the product owner. Please note important information below:

Distributor Name # _____

Model # _____

Manufacturer's Date _____

Serial / Registration # _____

Owner's Manual and Installation Guide

Thank you for purchasing an MTI bath product. You have chosen the best-built Mineral Composite tub in the USA. The outstanding heat retention, combined with the ease of cleaning and the elegant look will provide you with many years of pleasure. The instructions in this booklet will provide you with the information you need to install this unit. This information is also available on mtibaths.com.

Our customer service department is available to answer any additional questions you may have pertaining to the installation of your bath. Please call 800-783-8827 to speak to our Service Department or email service@mtibaths.com.

For faster service, please have your warranty registration number (serial number) ready when calling. The serial number can be found on the front of this Owner's Manual. Tubs equipped with an airbath blower will have a CSA sticker on the top of the air blower.



Table of Contents

Important Safety Instructions.....	1
Installation Instructions	2-9
Tubs.....	3
Air Bath	6
Air Bath Keypad and Remote Control Operating Instructions.....	10
Care and Cleaning Instructions	11
Troubleshooting.....	12-13
Residential Warranty.....	14-15
Commercial Warranty.....	16-17



Important Safety Instructions

This manual contains information and instructions for proper operation and maintenance of your MTI bathtub. Failure to follow these instructions could result in personal injury, electrical shock or fire.

Safety Instructions

INSTRUCTIONS PERTAINING TO RISK OF FIRE, ELECTRIC SHOCK, OR INJURY TO PERSONS.

WARNING: WHEN USING ELECTRICAL PRODUCTS, BASIC PRECAUTIONS SHOULD BE FOLLOWED INCLUDING THE FOLLOWING:

- ❗ Do not permit children to use this unit unless they are closely supervised by an adult at all times. Supervision is also required when bath is used by an elderly or handicapped individual.
- ❗ Never leave a full or filling bath unattended.
- ❗ Use this unit only for its intended use as described in this manual. Do not use attachments not recommended by the manufacturer. Never drop or insert any object into any opening.
- ❗ The water in a bath should never exceed 40° C (104° F). Water temperatures between 38° C (100° F) and 40° C (104° F) are considered safe for a healthy adult. Use time should be limited to approximately 10 minutes, followed by a shower to cool down. Longer exposures may result in hyperthermia, which can be fatal. The symptoms of this condition are nausea, dizziness and fainting. Lower water temperatures are recommended for extended use (exceeding 10 - 15 minutes) and for young children.
- ❗ Since excessive water temperatures have a high potential for causing fetal damage during the early months of pregnancy, pregnant or possibly pregnant women should limit water temperatures to 38° C (100° F).
- ❗ The use of drugs or alcoholic beverages before or during bathing may lead to unconsciousness with the possibility of drowning. Never use the bath while under the influence of alcohol, anticoagulants, stimulants, antihistamines, vasoconstrictors, vasodilators, hypnotics, narcotics or tranquilizers.
- ❗ Persons using medication should consult a physician before using a bath since medication may induce drowsiness while other medications may affect heart rate, blood pressure and circulation.
- ❗ **CAUTION:** Do not use harsh abrasives or solvents for cleaning this unit.
- ❗ **DANGER:** To reduce the risk of injury, enter and exit the bath slowly.
- ❗ **WARNING:** Never operate electrically connected devices in or within 5' of the bath. Never drop or insert any object into any opening within the bath.
- ❗ **DANGER:** Risk of electric shock. Connect only to circuits protected by a Ground Fault Circuit Interrupter (GFCI). Such a device should be installed by a licensed electrician and should be tested on a regular basis (at least monthly). To test the GFCI push the TEST button. The GFCI should interrupt the power. Push the RESET button and the power should be restored. If the GFCI fails to operate in this manner there is the possibility of an electric shock. **DO NOT USE.** Disconnect the unit and have the problem corrected by a qualified service technician. To avoid the possibility of personal injury and discoloration of the acrylic surface, the inlet water temperature should not exceed 60° C (140° F).
- ❗ **DANGER:** Disconnect power before servicing.
- ❗ A pressure wire connector is provided on the exterior of the pump or control within this unit to permit connection of a bonding conductor between this unit and all other exposed metal in the vicinity, as needed to comply with local requirements.

INSTALLER/OWNER BEARS ALL RESPONSIBILITY TO COMPLY WITH ALL STATE AND LOCAL CODES WHEN INSTALLING THIS PRODUCT.

- ❗ **IMPORTANT:** When required by local codes, install a RPZ (Reduced Pressure Zone) backflow prevention device to each faucet supply line

SAVE THESE INSTRUCTIONS

Installation Instructions

Read all instructions before installing tub. MTI recommends using a professional installer for this product. Installer/product owner is responsible for complying with all state and local codes. Handle this tub with extreme caution. Dropping this product, even from several inches, may cause cracking and permanent damage. Rubber gripped gloves may make it easier to handle the ESS bath.

WARNING: Certain cleaning products will permanently damage the mineral composite surface. Read product label carefully before using any cleaning product. Never use anything abrasive, aerosol sprays or any product that is described as “scrubbing bubbles.” Please see ‘Care & Cleaning Instructions’ on page 11.

BEFORE INSTALLING:

Inspect tub thoroughly.

- Damage from shipping or delivery must be reported to carrier immediately. **Do not install damaged tub. MTI is not responsible for damage occurring during transit.**
- Factory defect must be reported to factory before tub is installed. Defects or damage claimed after installation will be excluded from warranty.
- Measure tub on site carefully. Specifications are subject to change without notice. MTI is not responsible for any preparatory labor or materials.

Please note: Blemishes, air holes or casting marks on the underside of the bath are not considered defects and do not affect the performance or quality of the bath.

Always protect the tub from construction damage by using a protective cover. Damage, including chips and scratches incurred at the jobsite are excluded from warranty, but may be repaired by a qualified technician at the owner’s expense. Do not stand in the tub or store materials in the tub during construction. Tubs are intended for indoor use. Tubs are warranted for indoor installation in a climate controlled environment only.

Never leave a full or filling bath unattended.

WARRANTY CARDS & CSA LABELS:



IMPORTANT: Locate and note your serial number on the cover of this manual for any future service needs.



Installation Instructions

- ⓘ **ATTENTION:** This tub must be tested for operation and leaks prior to enclosure of surrounding areas. Failure to do so will void warranty. This tub was water tested at the factory and found to be fully operational and leak-free prior to shipping. Freight, handling and job site exposure may have deteriorated the tub's condition. It is the responsibility of the installer to thoroughly test the unit prior to installation. Tubs are intended for indoor use only. Tubs are warranted for indoor installation in a climate controlled environment only.

TEST PROCEDURES FOR AIR BATHS:

- Place the tub on a flat surface such as the driveway.
- Seal the drain with tape.
- Fill tub to overflow and allow tub to stand for five minutes without the blower running.
NOTE: The overflow is a plumbing device designed to help prevent water from reaching a certain level in your tub. Do not, under any circumstances, tape off or block the overflow in any way.
- Plug in the blower and any other components into a 110v GFCI outlet. Start the equipment and check for leaks by examining the area underneath and surrounding the tub.
- Check that all optional equipment is functioning properly and that the features on the tub match exactly what was ordered.
- If any leaks or operating problems are discovered, do not complete installation until problems are resolved. MTI will not be responsible for leaks claimed after the tub is installed, nor any costs involved with removing or reinstalling the tub or the costs of any surrounding materials or labor.

See troubleshooting section of this manual, call for assistance at 800-783-8827 or email service@mtibaths.com.

Always protect the tub from construction damage by using a protective cover. Damage, including chips and scratches, incurred at the jobsite is excluded from warranty, but may be repaired by qualified technician at the owner's expense. Do not stand in the tub or store materials in the tub during construction. Do not store tub in temperatures below 32 degrees Fahrenheit. Proper waste and overflow installation is the responsibility of the installer. MTI does not warrant leaks associated with improper waste and overflow installation.

Installation Instructions – Tubs with Integral Overflow

The integral overflow tubs by MTI Baths require only the waste to be installed. The P-trap will be located directly below the drain (see tub specification sheet). The tub comes equipped with a toe tap drain and PVC drain fitting.

⚠ MTI RECOMMENDS USING CLEAR 100% SILICONE SEALANT. DO NOT USE PLUMBER’S PUTTY.

WITH ACCESS FROM CEILING BELOW:

1. Adhere tub to the finished floor using clear silicone. Make sure that tub is precisely located where desired and that the hole in the floor for the drain aligns with the drain.
2. Install drain on tub using clear silicone under waste flange and on both sides of the rubber gasket on underside of the tub. MTI recommends using a small amount of clear silicone on the threads of the PVC drain fitting to act as a thread sealant. Tighten until it seals, plus one quarter turn. Finish installation from below by connecting PVC drain fitting to P-trap using PVC cement.
3. Allow time for silicone to cure and water test for leaks. Many products are ready to test in as little as 30 minutes. Please refer to product label for details.

WITHOUT ACCESS FROM BELOW:

1. Stub out drain and P-trap with 1 ½ schedule 40 PVC pipe at least 1” above finished floor. Because the height will vary slightly from tub to tub, box out around the pipe to allow trimming this pipe below grade upon installing the MTI supplied fitting. The fitting is approximately 3” in diameter.
2. Determine gap between underside of tub (at drain) and the floor. Shorten 1 ½ inch pipe to allow the supplied fitting and gasket height above the finished floor to match this gap. Glue fitting to pipe with PVC cement, again making sure the final height matches the gap (remember to allow for the thickness of the rubber gasket). Make sure that the top of the flange is level.
3. Use clear silicone to hold rubber gasket on top of flange. Apply another bead of silicone on top of gasket. Put a small amount of silicone in the top threads of PVC drain fitting to act as a thread sealant. Adhere tub to the finished floor using clear silicone. Immediately wipe off any excess silicone that may be on the floor or exterior of the tub. Make sure that the drain hole, gasket and flange align so that the waste flange can be threaded in from inside the tub.
4. Place a small bead of silicone under waste flange and thread into PVC drain fitting. Tighten until it seats plus one quarter turn.
5. Allow time for silicone and water test for leaks. Many products are ready to test in as little as 30 minutes. Please refer to product label for details.

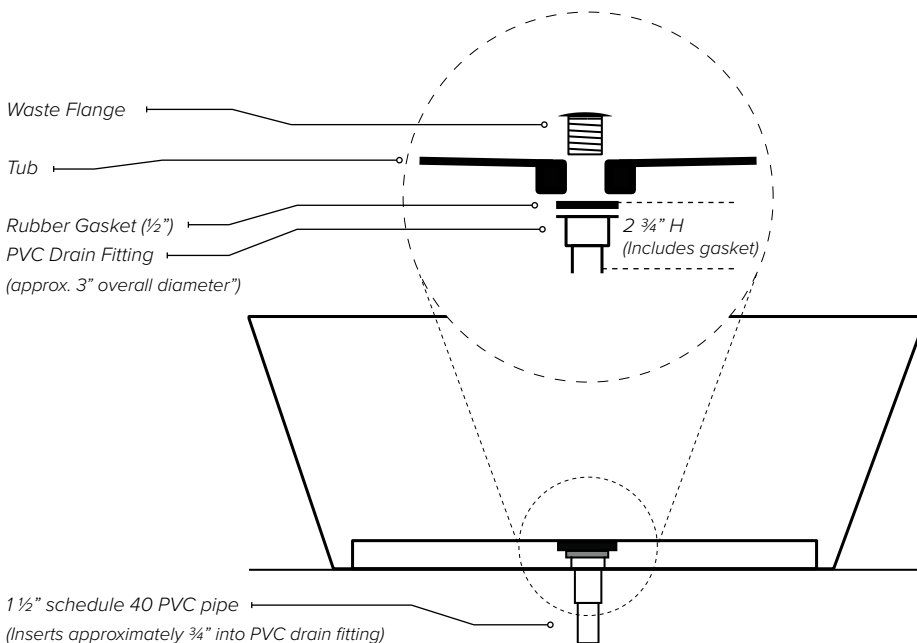



Installation Instructions – Airbath

The instructions on pages 7-9 apply to ALL air baths.

If your bath came equipped with an air system, there are several considerations and important installation procedures to follow.

Installation Instructions

1. The blower and check valve must be remotely located from the tub (See Illustration A on next page). The blower and check valve may be remote mounted up to 8' from the bath. The check valve must be located at least 2" above the top rim of tub. The air hose leading to the blower may be installed under the floor and the blower and check valve located inside a utility or linen closet. MTI does not recommend locating the blower more than 8' from the tub to prevent heat loss from the blower to the tub. Use care not to crush or restrict the airflow in the line in any way.

Note: 1" schedule 40 PVC pipe and pipe insulation may be used to help retain the warmth from the blower. Do NOT use insulation within 8" of the blower. The blower needs sufficient air space surrounding it for circulation, and must be installed in a climate controlled environment.

2. A 110V, 15 Amp GFCI outlet is required for the air blower. The blower is equipped with a 29" power cord to plug directly into this outlet. Keep in mind, the outlet, as well as any electrical equipment, must be easily accessible for any future service. The blower draws 9.5 amps.
3. The air hose that attaches to the check valve and manifold (factory installed underneath the tub), can exit the tub either through the side of the pedestal base or from directly underneath the tub, depending on the blower location. Side exit would only be used in cases where the tub is very close to the wall, or has cabinetry around it to conceal the plumbing. MTI does not pre-drill the pedestal base for side exit (**Photo A**).
4. The check valve MUST be mounted at least 2" above the top rim of the tub. A common location is near the blower in a closet or cabinet. The check valve can be mounted to the framing or wall with pipe hanger, pipe clamp, metal straps or wire ties (**See Illustration A on next page**).
5. Use 1" PVC flexible hose or rigid schedule 40 to connect the check valve to the tub. Connect the check valve to the blower using the grey hose provided. Secure blower using wood screws through the mounting feet. Connect the sensor wires to the blower (**See Illustration A on next page**). The sensor wires are factory installed to the two small chrome sensor heads on either side of the drain (**Photo B**) and allow the purge cycle to activate (see page 8 and/or step 8 at bottom of this page for more details about the automatic purge cycle). Do not attempt to remove the sensor wires from the tub. The sensor wires must be located and attached to the blower for proper operation.
6. Connect the keypad cable to the remote control module and the module to the blower. The keypad plugs into the jack on the right side and the cable from the left jack connects to the blower (**See Illustration B on next page**).
7. The keypad can be mounted convenient to the bather, or simply left unattached if only the remote control is desired.
8. Plug the blower into the outlet and test for operation. After the tub is turned off, the light on the keypad will be flashing, indicating the purge cycle is activated.

Note: All air baths are equipped with an automatic drying cycle. The blower will turn on for 1-2 minutes approximately 7 minutes after the bath is drained. The blower LED blinks during the drying cycle countdown. This drying cycle cannot be cancelled. Any attempt to cancel this cycle only resets the countdown timer.

PHOTO A

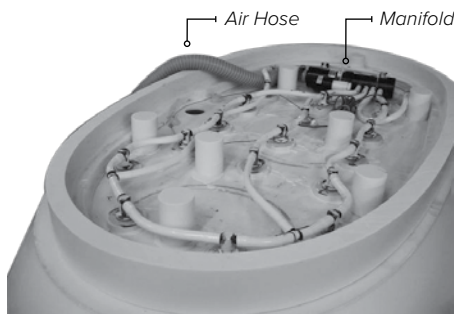
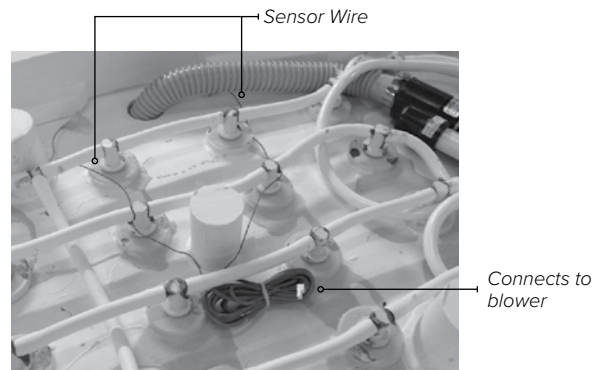

PHOTO B



Installation Instructions – Airbath

The following illustrations are referenced in the instructions on page 8.

ILLUSTRATION A

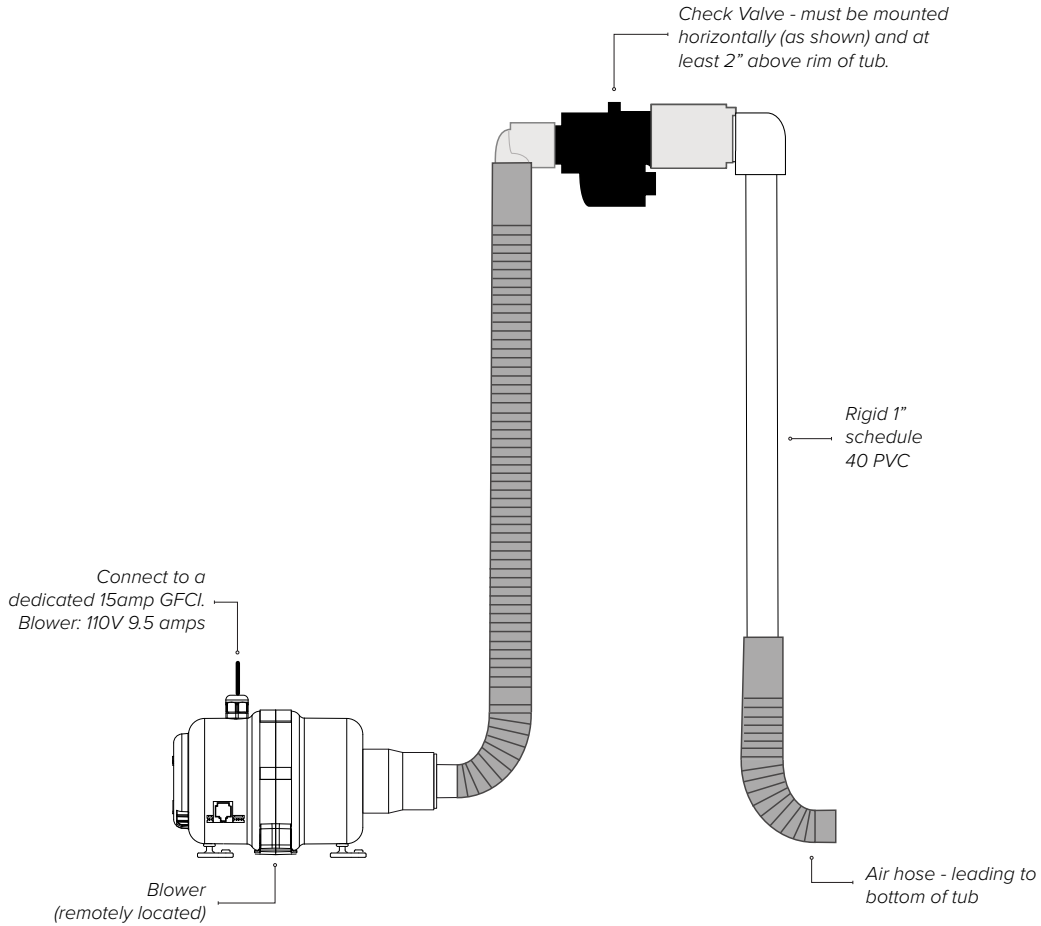
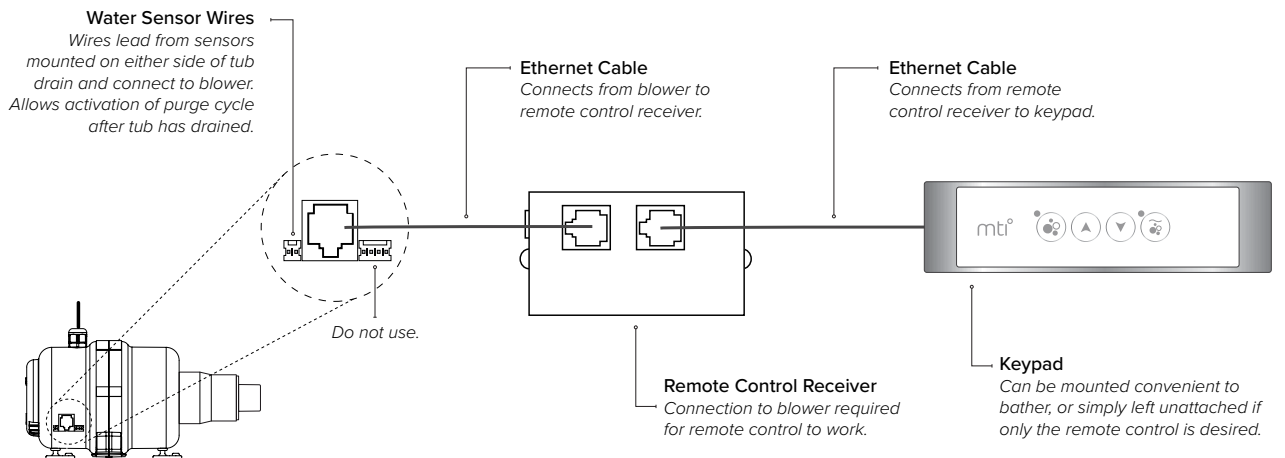
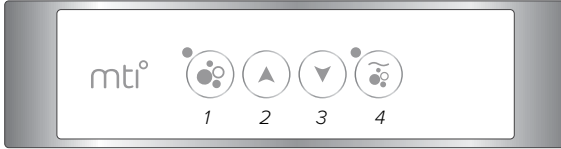

ILLUSTRATION B



Operation Instructions – Airbath Keypad and Remote

Note: Numbered instructions depict buttons in photo as seen from left to right on keypad or top to bottom on remote control.



Airbath Keypad

FUNCTIONS:



1. ON/OFF

1st Press: The blower starts. LED light on.
2nd Press: The blower stops. LED light off.



2. BLOWER SPEED INCREASE

Press & hold to increase the blower speed. Release pressure at the desired speed.
Note: The blower initially starts at 30% speed.



3. BLOWER SPEED DECREASE

Press & hold to decrease the blower speed. Release pressure at the desired speed.



4. SPA MODES

1st Press (Wave): Speed will vary gradually from maximum to minimum. LED light on.
2nd Press (Pulse): Speed will go directly to minimum and then straight back to maximum. LED light will flash.
3rd Press: Returns to maximum speed. LED light off.
 Press button #3 to decrease blower speed.

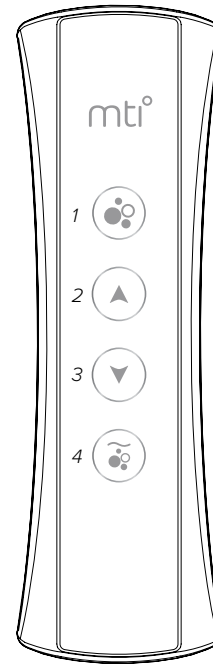

Airbath Remote Control

NOTE: Blower automatically stops after 20 minutes.

STANDARD DRYING CYCLE WITH WATER DETECTORS:

The system is equipped with two sensors on the floor of the bath near the drain. Every time water is introduced to the bath and drained, either by showering, bathing or cleaning, the sensors will activate the drying cycle. The cycle will start approximately 7 minutes after the bath is drained and run for 1-2 minutes. The drying cycle will activate even when the air system has not been turned on. The blower LED blinks (on keypad only) during the drying cycle countdown. This countdown cannot be cancelled. Any attempt to cancel this cycle only resets the countdown timer.

OPERATIONAL VIDEOS:

Please visit mtibaths.com/support/installation-operation/ for detailed operation instructions.

Care and Cleaning Instructions

The mineral composite surface of all MTI air baths and soaking baths is among the glossiest, highest quality surfaces available. Its hard, non-porous surface prevents dirt from accumulating and resists stains better than other materials. With normal use, your bath will retain its beauty with only a minimal amount of care. To maintain the high gloss, elegant look of the mineral composite (MC) surface, follow these simple steps:

- Use common household, non-abrasive cleaners for most cleaning jobs (for example: a mild dishwashing detergent such as Ivory Liquid). Follow manufacturer's directions and precautions. Do not use unless the product label specifically states that it is safe for acrylic or plastic. Rinse well and dry with a soft, clean cloth. Be sure to check the product label. Some products, although not containing abrasives, WILL damage the product over time. Never use any type of "scrubbing bubbles" or aerosol spray cleaners on your product unless it specifically states that it is safe for use on acrylic or plastic. Never use abrasive cleansers. If any product feels gritty when rubbed between your fingers, do not use on the product or controls as permanent damage will occur.
- Do not allow your mineral composite surface to come into contact with nail polish, nail polish remover, Wintergreen oil, dry cleaning solution, lacquer thinners, gasoline, pine oil, etc.
- Avoid using razor blades or other sharp objects that might scratch the surface. Small scratches can typically be removed.
- Remove dust and dry dirt with a soft, damp cloth.

MTI strongly recommends a professional surface repair person for deep scratches or chips.



Troubleshooting FAQ

FAQ

Q: THE BLOWER WILL NOT TURN ON. WHAT SHOULD I CHECK FIRST?

Check the electrical connections. Test the outlet for power by plugging in a small lamp or hair dryer. Check to make sure the breaker is not tripped. Replace GFCI outlet or breaker if necessary.

Q: THERE IS A RUST COLORED, GREASY RING IN MY BATH TUB. WHAT CAUSES THIS?

The condition results from sediment in the water heater of the home. Drain and flush the heater according to the manufacturer's instructions, and then clean the interior of the tub with a mild, grease cutting dish soap.

Q: THE BLOWER IS TURNING ON, YET THE AIR JETS ON MY TUB ARE NOT BLOWING AIR BUBBLES. WHAT COULD BE THE PROBLEM?

One or more connections may have been unplugged during installation. Check that the grey air hose from the air blower to the manifold, and from the manifold to the tub, is properly connected. If necessary, reconnect and tighten clamps. See illustration on page 9.

Q: I HAVE AN MTI AIR BATH, AND IT APPEARS TO JUST TURN ON EVEN IF WE NOT IN THE TUB.

Each MTI Boutique Series air bath is equipped with a pair of sensors near the drain of the bath. They appear as two small chrome buttons. Every time water is introduced into the bath, even if the air system was not used, the air system will automatically activate approximately 7 minutes after the water has drained out of the tub in order to purge the system of any small droplets of water. The system will turn off in approximately 1 minute.

Q: I UNDERSTAND THE PURGE CYCLE, HOWEVER, MY TUB IS NOW PURGING IN THE MIDDLE OF THE NIGHT, HOW CAN I STOP THIS FROM HAPPENING?

Small, barely detectable power fluctuations may have disrupted the purge cycle. Turn the breaker off (or unplug the blower), wait for ten seconds, then plug back in. The blower should now follow the normal purge cycle.

Q: THE AIR BUBBLES SEEM COOL. HOW DO I CHECK THAT THE BLOWER IS WARMING THE AIR?

To verify, turn the air system on high for 4-5 minutes (you do not need to have water in the tub). Carefully feel the grey air hose where it exits the blower. It should be warm to the touch. If it is cold, please contact MTI for service. Please note that some skin sensitive people might experience the so-called "cold air effect", which is caused by the actual sensation of air bubbles running along the skin, giving the bather a "shivering" sensation.

Note: Even if the air entering the tub was hot enough to burn the skin, this shivering effect would still persist.

The heated blower is not designed to heat your bath water, just to pre-heat the incoming air. The air hose and blower must be installed in a climate controlled environment. Pipe insulation may be used to insulate the air hose, however, do not insulate the blower itself; the blower needs sufficient air space surrounding it for proper circulation and operation.

Q: IS IT SAFE TO USE BATH SALTS OR BATH OILS IN MY TUB?

Water soluble products such as bath salts are fine to use, however, MTI does not recommend the use of heavy bath oils. If bath oil is used, refer to the care and cleaning section of this manual for proper after-care and cleaning instructions.

Q: HOW CAN I GET SCRATCHES OUT OF MY MINERAL COMPOSITE TUB?

Most scratches and scuffs can be easily sanded out. Please contact MTI's service department for instructions. Deeper scratches and chips may require the services of a professional repair technician.

Q: MY BATH'S AIR SYSTEM HAS BEEN WORKING GREAT FOR YEARS, AND THEN SUDDENLY JUST STOPPED WORKING. WHAT SHOULD I CHECK FIRST?

The problem is most likely the breaker or the GFCI outlet. Check your breaker box first, and then use a hairdryer to test the outlet where the equipment is plugged in. This should identify the problem. If both these items check out fine, please have your serial or registration number available and contact MTI's service department.

Q: THE REMOTE CONTROL FOR MY AIR BATH NO LONGER FUNCTIONS. WHAT CAN I DO?

Barely detectable power fluctuations may occasionally disrupt the remote control operation. To correct:

1. Turn off the breaker or unplug the blower, then turn it on again.
2. Within 15 seconds, simultaneously press the "plus" and "minus" buttons, hold down for four seconds, and release. The remote is now ready for use.
3. If the synchronization is not successful, simply repeat the steps.

If the remote is still inoperable, please have your serial or registration number available and contact MTI's service department. The remote control is a non-serviceable, sealed control, so it cannot be repaired on site.

MTI Residential Warranty

This warranty is effective for all MTI Mineral Composite (MC) tubs manufactured after **January 1, 2018**, and is in lieu of all other warranties. MTI Baths, Inc. (MTI) provides a limited warranty for all MC tubs for use in the continental USA to the **original purchaser** for commercial, rental or multi-family application. Warranty coverage begins from date of purchase (regardless of installation date).

TEN-YEAR BATH SHELL WARRANTY:

MTI warrants the MC tub against defects in material and workmanship for a period of ten years from date of purchase. The tub must be water tested and installed per our installation instructions. MTI will not be responsible for the cost of removing or reinstalling the unit, or costs associated with any adjacent materials. MTI does not warrant leaks associated with improper waste and overflow installation or damages from over-filling the bath. Never leave a full bath or filling bath unattended. Blemishes, air holes or casting marks on the underside of the bath are not considered defects and do not affect the performance or quality of the bath. Slight variations in the surface are indigenous to the natural stone appearance of the product and are not considered defects or flaws. Variations in the surface do not compromise the structural integrity of the product.

TEN-YEAR AIR BATH WARRANTY:

MTI warrants our MC air baths for ten years. The non pro-rated warranty covers the blower against defects in material or workmanship. All other components, even those included in MTI packages are subject to the MTI Two-Year parts warranty described below. **The bath must be water tested for operation and leaks prior to final installation of the unit.** Failure to do so will void warranty. If a problem is discovered after the final installation, MTI will not be responsible for the cost of removing or reinstalling the tub, or for costs associated with any adjacent materials. Proper drain installation is the responsibility of the installer. MTI's warranty does not cover drain leakage.

TWO-YEAR (PARTS ONLY) WARRANTY:

MTI warrants all other components not specified above for two years for parts only against defects in material or workmanship. Replacement parts shall assume the remaining warranty period of the parts replaced. Replacement parts are subject to availability and may differ from those originally supplied. MTI cannot guarantee that parts currently in use will be available in the future. Changes in materials, parts or specifications are not valid reasons for product refusal or replacement under warranty claims.

RETURN OF WARRANTY CARD:

The warranty registration card must be filled out by the purchaser within one hundred twenty days from purchase and mailed to MTI Baths in order for this warranty to take effect. Warranty registration can also be completed online at mtibaths.com/support/online-warranty.

WARRANTY LIMITATIONS:

Your warranty is void if unit is not water tested for leaks and inspected prior to completing installation. Our warranty does not cover defects, damage, or failure caused by common carrier, installer, user, or other person. **Minor chips and scratches (normal wear and tear) can be repaired by a qualified technician at the owner's/user's expense.** We do not cover the following: careless handling; modification of any type for any reason; improper installation (see Installation Instructions); connections supplied by the installer; misuse; incorrect or improper maintenance; use of improper cleaners and/or chemicals; cigarette burns or burns from hot appliances; or extraordinary acts such as earthquakes, hurricanes, lightning, floods, hail, etc. Staining from food or beverages (such as red wine), medicinal products (such as mecurochrome), use of improper cleaning products, make-up, etc... is not covered under warranty.

EXTENT OF WARRANTY:

This warranty extends only to the original consumer/purchaser of the MTI Baths product when purchased and originally installed within the boundaries of the continental USA. The warranty terminates after transfer of ownership or if the tub is installed or relocated outside the boundaries of the continental USA* by the original consumer/purchaser prior to the expiration of the warranty period. Display floor models and overstock sale units are excluded from this warranty. See commercial warranty for commercial installation coverage.

CONTINUED ON NEXT PAGE...



WARRANTY PERFORMANCE:

In the event of any malfunction or defect covered under the terms of this warranty, a Factory Authorized Service Agent of MTI Baths will repair the MTI product. To obtain service, contact the MTI Service Department for an agent in your area and issuance of a service order number. No work/payment will be made without an authorized service order number. There will be no charge for parts, labor or freight costs for parts necessary to repair the tub under warranty. Written notice of any malfunction or defect must be given within ten days of the time the malfunctions were discovered, and must be accompanied by proof of purchase. Notice must be given to MTI Baths, 670 N. Price Road, Sugar Hill, GA 30518, Attn: Service Department. MTI reserves the right to inspect the malfunction or defect on site and repair or replace the unit at our discretion.

ACTS INVALIDATING WARRANTY:

Inspecting the unit prior to installation is the responsibility of the installer(s) or person(s) acting on behalf of the product owner. He/she is responsible for ensuring that the unit is free of defect or damage. Our shipping container advises the installer of this responsibility. MTI is not responsible for failure or damage that should have been discovered, repaired and avoided by proper inspection and testing prior to installation. Damage that occurred in transit is the responsibility of the carrier. The consignee must open and inspect the unit for damage when it is delivered. If the unit is damaged, this must be reported immediately to both the seller and the carrier in writing and an inspection must be requested. In the event that the carrier fails to respond, report such response to both the seller and the carrier. Any freight claims must be filed within ten business days. It is the responsibility of the installer, contractor, or user to install the unit properly allowing for access for service. The check valve on all air baths must be installed 2" above the water line of the tub. Access must be provided to **each** air blower and/or electrical component on your tub. The access panel(s) must have a minimum size of 16"x14" for installation and future servicing of the equipment. MTI Baths, Inc. will not authorize any service unless **clear** access is available. Access from a crawlspace or incomplete access to all equipment may result in warranty claims being denied. Unit must be water tested for leaks prior to final installation. Damage, including chips or scratches, occurring to the unit during installation is the responsibility of the installer and after installation is the responsibility of the product owner.

MTI BATHS IS NOT LIABLE FOR INCIDENTAL OR CONSEQUENTIAL DAMAGE, LOSS OF TIME, INCONVENIENCE, INCIDENTAL EXPENSES, LABOR OR MATERIAL CHARGES OR ANY OTHER COSTS RELATED TO THE APPLICATION OF THIS WARRANTY. NEVER LEAVE A FILLING OR FULL BATH UNATTENDED.

DISCLAIMERS:

MTI Baths is not responsible for incidental or consequential damages/losses from any cause such as water damage to carpeting, floors or ceilings. Optional equipment not manufactured by MTI or installed by MTI is not covered. Damages or defects that should be detected before installation are not covered. The limited warranty does not include labor, transportation, or other costs incurred in the removal and/or reinstallation of the original unit or replacement unit. Costs related to obtaining access for repair are not covered. The foregoing warranty is EXCLUSIVE and in lieu of all other warranties, including any other warranty of quality, express or implied, and including any warranty of merchantability, or any warranty of fitness for any particular purpose.

CUSTOMER SERVICE:

To verify coverage or request service, please contact the MTI Service Department at 800-783-8827 or email at service@mtibaths.com. Please have serial or registration number available.

MTI Commercial Warranty

This warranty is effective for all MTI Mineral Composite (MC) tubs manufactured after **January 1, 2018**, and is in lieu of all other warranties. MTI Baths, Inc. (MTI) provides a limited warranty for all MC tubs for use in the continental USA to the **original purchaser** for commercial, rental or multi-family application. Warranty coverage begins from date of purchase (regardless of installation date).

TWO-YEAR BATH SHELL WARRANTY:

MTI warrants the MC tub against defects in material and workmanship for a period of two years from the date of purchase. The tub must be water tested and installed per our installation instructions. MTI will not be responsible for the cost of removing or reinstalling the unit, or costs associated with any adjacent materials. MTI does not warrant leaks associated with improper waste and overflow installation or damages from over-filling the bath. Never leave a full bath or filling bath unattended. Blemishes, air holes or casting marks on the underside of the bath are not considered defects and do not affect the performance or quality of the bath. Slight variations in the surface are indigenous to the natural stone appearance of the product and are not considered defects or flaws. Variations in the surface do not compromise the structural integrity of the product.

TWO-YEAR AIR BATH WARRANTY:

MTI warrants our MC air baths for two years. The non pro-rated warranty covers the blower against defects in material or workmanship. All other components, even those included in MTI packages are subject to the MTI One-Year parts warranty described below. **The bath must be water tested for operation and leaks prior to final installation of the unit.** Failure to do so will void warranty. If a problem is discovered after the final installation, MTI will not be responsible for the cost of removing or reinstalling the tub, or for costs associated with any adjacent materials. Proper drain installation is the responsibility of the installer. MTI's warranty does not cover drain leakage.

ONE-YEAR (PARTS ONLY) WARRANTY:

MTI warrants all other components not specified above for one year for **parts only** against defects in material or workmanship. Replacement parts shall assume the remaining warranty period of the parts replaced. Replacement parts are subject to availability and may differ from those originally supplied. MTI cannot guarantee that parts currently in use will be available in the future. Changes in materials, parts or specifications are not valid reasons for product refusal or replacement under warranty claims.

RETURN OF WARRANTY CARD:

The warranty registration card must be filled out by the purchaser within one hundred twenty days from purchase and mailed to MTI Baths in order for this warranty to take effect. Warranty registration can also be completed online at mtibaths.com/support/online-warranty.

WARRANTY LIMITATIONS:

Your warranty is void if unit is not water tested for leaks and inspected prior to completing installation. Our warranty does not cover defects, damage, or failure caused by common carrier, installer, user, or other person.

Minor chips and scratches (normal wear and tear) can be repaired by a qualified technician at the owner's/user's expense. We do not cover the following: careless handling; modification of any type for any reason; improper installation (see Installation Instructions); connections supplied by the installer; misuse; incorrect or improper maintenance; cigarette burns or burns from hot appliances; use of improper cleaners and/or chemicals; or extraordinary acts such as earthquakes, hurricanes, lightning, floods, hail, etc. Staining from food or beverages (such as red wine), medicinal products (such as mecurochrome), use of improper cleaning products, make-up, etc... is not covered under warranty.

EXTENT OF WARRANTY:

This warranty extends only to the original consumer/purchaser of the MTI Baths product when purchased and originally installed within the boundaries of the continental USA. The warranty terminates after transfer of ownership or if the tub is installed or relocated outside the boundaries of the continental USA by the original consumer/purchaser prior to the expiration of the warranty period. Display floor models and overstock sale units are excluded from this warranty.

CONTINUED ON NEXT PAGE...



WARRANTY PERFORMANCE:

In the event of any malfunction or defect covered under the terms of this warranty, a Factory Authorized Service Agent of MTI Baths will repair the MTI product. To obtain service, contact the MTI Service Department for an agent in your area and issuance of a service order number. No work/payment will be made without an authorized service order number. There will be no charge for parts, labor or freight costs for parts necessary to repair the tub under warranty. Written notice of any malfunction or defect must be given within ten days of the time the malfunctions were discovered, and must be accompanied by proof of purchase. Notice must be given to MTI Baths, 670 N. Price Road, Sugar Hill, GA 30518, Attn: Service Department. MTI reserves the right to inspect the malfunction or defect on site and repair or replace the unit at our discretion.

ACTS INVALIDATING WARRANTY:

Inspecting the unit prior to installation is the responsibility of the installer(s) or person(s) acting on behalf of the product owner. They are responsible for ensuring that the unit is free of defect or damage. Our shipping container advises the installer of this responsibility. MTI is not responsible for failure or damage that should have been discovered, repaired and avoided by proper inspection and testing prior to installation. Damage that occurred in transit is the responsibility of the carrier. The consignee must open and inspect the unit for damage when it is delivered. If the unit is damaged, this must be reported immediately to both the seller and the carrier in writing and an inspection must be requested. In the event that the carrier fails to respond, report such response to both the seller and the carrier. Any freight claims must be filed within ten business days. It is the responsibility of the installer, contractor, or user to install the unit properly allowing for access for service. The check valve on all air baths must be installed 2" above the water line of the tub. Access must be provided to **each** air blower and/or electrical equipment on your tub. The access panel(s) must have a minimum size of 16"x14" for installation and future servicing of the equipment. MTI Baths, Inc. will not authorize any service unless **clear** access is available. Access from a crawlspace or incomplete access to all equipment may result in warranty claims being denied. Unit must be water tested for leaks prior to final installation. Damage, including chips or scratches, occurring to the unit during installation is the responsibility of the installer and after installation is the responsibility of the product owner.

MTI BATHS IS NOT LIABLE FOR INCIDENTAL OR CONSEQUENTIAL DAMAGE, LOSS OF TIME, INCONVENIENCE, INCIDENTAL EXPENSES, LABOR OR MATERIAL CHARGES OR ANY OTHER COSTS RELATED TO THE APPLICATION OF THIS WARRANTY. NEVER LEAVE A FILLING OR FULL BATH UNATTENDED.

DISCLAIMERS:

MTI Baths is not responsible for incidental or consequential damages/losses from any cause such as water damage to carpeting, floors or ceilings. Optional equipment not manufactured by MTI or installed by MTI is not covered. Damages or defects that should be detected before installation are not covered. The limited warranty does not include labor, transportation, or other costs incurred in the removal and/or reinstallation of the original unit or replacement unit. Costs related to obtaining access for repair are not covered. The foregoing warranty is EXCLUSIVE and in lieu of all other warranties, including any other warranty of quality, express or implied, and including any warranty of merchantability, or any warranty of fitness for any particular purpose.

CUSTOMER SERVICE:

To verify coverage or request service, please contact the MTI Service Department at 800-783-8827 or email at service@mtibaths.com. Please have serial or registration number available.



This page intentionally left blank.



This page intentionally left blank.



This page intentionally left blank.



MTI Baths
670 North Price Road
Sugar Hill, GA 30518
p: (800) 783-8827
f: (800) 438-8827



Made in the USA

mtibaths.com

© Copyright 2019 by MTI Baths, Inc.
Modification Rights Reserved. 0319